

# Brodart Contract Furniture



## 2009 Price List

Clinton County Industrial Park ▪ 280 North Road ▪ McElhattan, PA 17748

Toll-Free: 1-888-521-1884 ▪ Fax: 1-570-769-7614

[www.brodartfurniture.com](http://www.brodartfurniture.com) ▪ [www.brodartcreative.com](http://www.brodartcreative.com)



**Table of Contents**  
**Brodart Contract Furniture**  
**List Prices - January 1, 2009**

<b>Table of Contents</b>	3	<b>Continuous Tops</b>	
<b>General Information</b>	4	<b>For Steel Shelving</b>	
<b>Product Options</b>	6	64 Series	138
<b>Brodart Creative</b>	8	Chancellor's Collection	139
Grid Systems	9	Epoch Collection	140
Way Finding	10	Matrix	141
End Panels	11	Quorum 94T	142
<b>Circulation Desks</b>		Modifications for Continuous Tops	143
Circulation Desk Reference Guide	12	<b>End Panels</b>	
Berwyn Collection	14	Berwyn	144
Calista Circulation Desk	16	Chancellor's Collection	146
Chancellor's Collection	18	Epoch Collection	148
Epoch Collection	20	Horizons	150
Horizons Collection	24	Matrix	152
Matrix Series	26	Quorum 94T	154
Maxim Desk	28	Slatwall End Panels	156
Office Desks (Quorum 94T)	30	<b>Display Furniture</b>	
Circulation Desk Accessories Reference Guide	32	Atlas/Dictionary Stands	158
Accessories	33	A-Frame Display Shelving	160
Circulation Desk Modifications	36	Exhibit Cases	160
<b>Tables</b>		Gondola Metal Display Shelving	161
2be! Series	38	End of Range	162
Berwyn Collection	44	Magazine & Newspaper Displayers	162
Chancellor's Collection	46	Slatwall Shelving & Display	163
Epoch Collection (Wood, Metal, & Chrome Legs)	48	Specialty Shelving	163
Horizons (Wood & Metal Legs)	52	Miscellaneous/Mobile Displayers	164
Libris (Wood & Metal Legs)	58	Horizons Display Furniture	164
Matrix (Wood & Metal Legs)	64	Multimedia Display & Storage	165
M-Table	68	Epoch Collection CD/DVD Storage & Display	165
Quorum 94T	74	Revolving, Tower, & Picture Book Display	166
Table Modifications	78	Book Trucks	167
<b>Computer Furniture (Info Access, LTS, OPAC)</b>		<b>Seating</b>	
Berwyn Collection	80	Alpha Chair	168
Chancellor's Collection	82	B-Series Seating & Stools	169
Epoch Collection	86	Carver Chair	171
Horizons Collection	92	D-Series Chair	172
Libris (Wood & Metal)	94	Entry Chair Collection	173
Matrix (Wood & Metal)	98	Ergonomic Seating	174
M-Table	102	Essex Chair	175
Quorum 94T Series	104	Horizons Seating	176
Computer Furniture Modifications	108	Melis Chair	177
<b>Electrical</b>	110	Metro Chair	178
<b>Standard Shelving (Single &amp; Double Faced)</b>		Netta Chair	179
Wood	116	Oxford Chair	180
Omega (metal)	120	Parallax Chair	181
Omega Book Stop (metal)	122	Two-Position Chair	182
Mobile Shelving	125	<b>Lounge Seating</b>	
<b>Shelving Parts &amp; Accessories</b>		Berwyn	184
Backs & Partitions	126	Chancellor's Collection	184
Accessories	127	L4 Series	185
Shelving Parts	127	L5 Series	185
Shelving Modifications & Up Charges	130	<b>Lounge Tables</b>	
<b>Continuous Tops</b>		Berwyn Collection	186
<b>For Wood Shelving</b>		Chancellor's Collection	186
64 Series	132	Epoch Collection (Wood, Metal, & Chrome Legs)	186
Chancellor's Collection	133	LX Series	186
Epoch Collection	134	Libris (Wood & Metal Legs)	187
Matrix	135	Quorum 94T	187
Quorum 94T	136	Cylinder & Cube Tables	187
Modifications for Continuous Tops	137		

**General Information**  
**Brodart Contract Furniture**  
**List Prices – January 1, 2009**

**ORDERING INSTRUCTIONS**

Your order can be entered and acknowledged promptly only if you supply us with certain essential information:

- a. Each item to be purchased must be identified by a complete catalog number.
- b. The quantity of each item to be purchased.
- c. If an item is modified in any way, the letters "MOD" must be used as a suffix on the catalog number.
- d. Unit price and extended price as determined from the Brodart price list, or a quotation from Brodart.
- e. If shop drawings are needed, note this requirement on your purchase order. You must supply architectural prints of pertinent building areas when requesting shop drawings.
- f. Additional detailed information, as specified by the attached "Order Information" checklist, must be supplied before your order can be processed.

Failure to supply essential order information may result in delays in the processing of your order.

**TERMS AND CONDITIONS**

**Prices**

These prices supersede all previously issued prices. All prices herein are list prices, unless otherwise noted, and are subject to change without notice. Prices stated are for our standard finishes and laminates. Special finishes are subject to an up charge. Up charges for special laminates will be quoted upon request.

**Discounts**

Discounts can be obtained by contacting a Project Coordinator. When obtaining discounts, you must be prepared to provide total list price information, estimated delivery dates, as well as all other information located on the Discount Request Form.

**Payment Terms**

Net 30 days from date of invoice, F.O.B. Factory

**Taxes**

Any sales or excise tax, or any other tax or government charge now or hereafter levied upon the product, sale, use or shipment of goods shall, at the Company's option, be charged to the customer.

**Orders**

All orders are subject to acceptance by Brodart Co., 280 North Road, Clinton County Industrial Park, McElhattan, PA 17748.

**Acknowledgements**

Brodart will ship products as detailed on the acknowledgement. Please confirm that all items are ordered as intended. Brodart will not accept responsibility for products shipped as acknowledged.

**Cancellations**

All orders are considered firm and cannot be cancelled without Brodart's approval. A cancellation charge will be required based on costs incurred. Minimum cancellation charge will be \$50.00

**Order Changes**

Changes to orders already in process are subject to a charge covering the making of the change. You will be required to indicate your acceptance of the additional costs before Brodart can proceed with the change. Minimum charge is \$50.00, other charges are as follows: Within 8 weeks of ship date minimum – charge is \$150.00 plus any material costs incurred. Once the job is within 6 weeks and is in full production - minimum charge is \$350.00 for the change and any material and labor costs involved. Brodart reserves the right to deny change requests within 6 weeks of the ship date.

**Shipment**

Standard shipping is 8-10 weeks. Timeframe is 10-12 weeks for Berwyn, Chancellor's, Epoch, and all modified products (i.e. approved shop drawings, color, etc.).

**Claims – Freight**

All shipments are delivered to common carriers in good condition. Brodart's liability ceases once the order is delivered to the carrier. If your order is received short or damaged, you should note on your freight bill and file a claim immediately with the carrier.

**Claims – Product**

Claims against Brodart for defects, errors or shortages must be made by the purchaser, in writing, within 30 days after delivery. Failure to make such claim shall constitute full acceptance of the merchandise.

**Return**

No Merchandise may be returned for credit without our previous agreement. Unauthorized returns will not be accepted.

**Warranty**

Brodart warrants that the Furniture designed and manufactured by it will be free of defects in material and workmanship for a period of five (5) years. Exception is the Brodart Creative furniture line, which is warranted for a period of one (1) year.

Please refer to the official warranty documents for more information.

**Product Specifications**

Product specifications are subject to change without notice.

**Sample Policy**

The requesting party will:

- a. Submit a purchase order for desired samples.
- b. Receive an invoice for samples shipped.
- c. Pay the invoice for samples, including transportation charges

Pricing:

**FULL-SIZED SAMPLES** - Will be billed at a substantial discount from current list prices.

**CORNER SAMPLES/MINI-SHELVING SAMPLES** - Will be billed at a nominal charge for each sample.

Samples may not be returned for credit.

**UL-Labeling**

Brodart product lines that have been approved by Underwriters Laboratories Inc. (UL) are noted. To receive UL labels you must request "UL Labels" on your order.

**COM Fabrics**

All fabrics sent to Brodart must be shipped PREPAID and tagged with the Project Name, Item Number, Brodart Sales Order Number (if available), and Project Manager's name. Ship to: *Brodart Co., 280 North Road, Clinton County Industrial Park, McElhattan, PA 17748 Attention: Furniture Marketing.*

**Custom Finish**

Custom finishes on orders over \$5,000.00 **net** will not require a special finish fee. On orders under \$5,000.00 contact Brodart for a quotation. On orders where the finish is more than a one-step or multi-step finish, a special up charge will be applied. Contact Brodart for a quotation.

**Modified Products**

Modifications in dimension, wood species, and design are available for an additional fee. For any charges not listed in this Price List, please contact a Project Coordinator.

**BRODART CREATIVE****Warranty**

Brodart Creative warrants that the products designed and manufactured by it will be free of defects in material and workmanship for a period of one (1) year.

**Deposit**

A 50% deposit is required on all Brodart Creative products.

**Design Fees**

Design fees for Brodart Creative may apply.

**Product Options**  
**Brodart Contract Furniture**  
**List Prices – January 1, 2009**

**WOOD OPTIONS**

Oak Wood:

Clear On Oak	O33	Solar on Oak	716	Dark on Oak	801
Natural Oak	O89	Champagne on Oak	837		

Maple Wood:

Clear on Maple	M33	Porcelain on Maple	654
Antique on Maple	343	Victorian on Maple	790

Cherry Wood:

Clear on Cherry	C33	Porcelain on Cherry	654
Antique on Cherry	343	Victorian on Cherry	790

Pigmented Stains (Formulated for Maple Wood):

Grasshopper	570	Pumpkin	515	Mustard	MUS
Storm	546	Fern	FRN	Sky	SKY
Peaceful Blue	520	Cranberry	CRN		
Dark Chocolate	538	Ginger	GNG		

**Finish Note:**

The wood finishes listed above are specifically formulated for the wood species listed. Color may vary significantly if the stain is used on a different species of wood.

Color may vary on the same wood species due to grain and texture differences. Solid wood and matching veneer have distinct grain and color variations. Harmonious color variations will appear in each Brodart furniture piece.

**Custom Finish:**

Custom finishes on orders over \$5,000.00 **net** will not require a special finish fee. On orders under \$5,000.00 contact Brodart for a quotation. On orders where the finish is more than a one-step or multi-step finish, a special up charge will be applied. Contact Brodart for a quotation.

**PLASTIC LAMINATES**

Wilsonart laminates are preferred for Brodart Furniture. Brodart will use any other laminate vendor (Pionite, Formica, Nevamar, etc.) as well, but doing so may result in change in lead time and/or an up charge. For an up-to-date listing of available Wilsonart Laminates, please visit: [www.wilsonartcontract.com/](http://www.wilsonartcontract.com/).

Alternatives to plastic laminate are available as well. If an alternative to plastic laminate (such as Corian or Marmoleum) is desired, please refer to the "modifications" sections throughout this price list or contact your Project Manager for more information.

**METAL OPTIONS**

**Powder Paint Guidelines & Up-Charges:**

Brodart's standard paint colors are available at no charge. Brodart "Select" colors are available at a **net** up-charge of \$500.00 per color, per order. Custom powder paints are available as well; please call Brodart for pricing and availability.

"Standard" Paint Colors:

Sand Omega	R3500051	F/T Black (Black Jack)	R3500050	Sepia Hammertone	R3500088
Almond Omega	R3500057	F/T Anthracite Metallic	R3500097	Nu Black Hammertone	R3500078
Red Omega	R3500052	F/T Bronze Mist	3001787	Capri Blue Hammertone	R3500079
Blue Omega	R3500060				
Gray Omega	R3500053	Metallic Anthracite	R3500070	Antique White	R3500093
Burgundy Omega	R3500061	Metallic Beige	R3500071	Antique Gold	R3500091
Yellow Omega	R3500064	Metallic Bengal Black	R3500095	Antique Silver	R3500092
Hunter Green Omega	R3500063	Metallic Bengal Silver	R3500096	Antique Copper	R3500090
Brown Omega	R3500055	Metallic Copper	R3500073		

"Select" Paint Colors:

F/T Blue	R3500098	Sapphire Hammertone	R3500087	Metallic Sun Gold	R3500077
F/T Pale Yellow	R3500099	Silver Hammertone	R3500089	Metallic Bronze	R3500072
F/T Red	R3500100	Light Silver Hammertone	R3500082	Metallic Jeans	R3500076
				Metallic Gray	R3500074

**Note:** F/T designates "Fine Textured" Powder Paint

**FABRIC OPTIONS**

Yardage requirements are listed under each product line. Yardages indicated in this price list are for non-directional 54" wide upholstery fabric. Additional yardage will be required if your upholstery fabric deviates in any way from "non-directional 54" wide".

**Fabric Grade Information:**

G1 Fabric Listed in this Price List – Marquesa Lana, All Sherpa & Shire Colors  
 G2 Fabric Listed in this Price List – A & D Crypton Suite Style Collection

California Technical Bulletin #133 treatment is available on all Crypton Upholstery at a NET charge of \$15.00/yard

**COM Fabrics:**

All fabrics sent to Brodart must be shipped PREPAID and tagged with the Project Name, Item Number, Sales Order Number (if available), and Project Manager's name. Ship to: *Brodart Co., 280 North Road, Clinton County Industrial Park, McElhattan, PA 17748 Attention: Furniture Marketing.*

**GLASS OPTIONS (Epoch Series)**

Artic Blue	GAB	Gator Bronze	GGB	Rock Ice Solex	GRI
Bronze	GBR	Gray	GGR	Wave Starfire	GWS
Bubble Evergreen	GBE	Greylite	GGL		
Evergreen	GEV	River Blue	GRB		

**SHELVING OPTIONS**

**Maple Shelving:**

All part numbers for shelving are listed in Oak wood (unless otherwise noted). To order in Maple wood, reverse the first two numbers of the listed part number. For example, **S1-861-S00** or **S2-861-S00** in Maple would be **1S-861-S00** or **2S-861-S00**

**Clip & Strip Shelving:**

All Shelving (with the exception of Glass Door Shelving) is listed as Pin & Hole construction. Clip & Strip shelving is available for Wood Shelf units **ONLY** and can be ordered by changing the **S1** prefix on the starter unit to **S3**, and changing the **S2** prefix on the adder unit to **S4**. I.e.: **S3-861-S00** or **S4-861-S00**.

**Note:** Up Charge for Clip & Strip shelving is 10% over wood shelving prices

**Sub-tops (to accept continuous HPL tops – sold separately):**

Sub-tops for shelving (to accept continuous HPL Tops – sold separately) are available and can be ordered by changing the **S00** extension on the catalog number to **S02**. I.e.: **S1-861-S02**.

Pricing for shelving units with sub-tops (to accept continuous HPL tops):  
 10", 12", and 16" \$33.00 List deduct per unit  
 20", 24", and 32" \$65.00 List deduct per unit



**Individual HPL Tops:**

Individual HPL tops for shelving are available and can be ordered by changing the **S00** extension on the catalog number to **S03**. I.e.: **S1-861-S03**

Up Charge for Individual HPL tops:  
 10", 12", and 16" \$60.00 List add per unit  
 20", 24", and 32" \$82.00 List add per unit

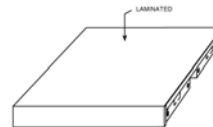

**Chancellor Sketch Face Veneers:**

Chancellor sketch face veneers on wood shelving end panels are available.

Up Charge for Chancellor sketch face veneers:  
 For One Panel Add 55% to the starter price  
 For Two Panels Add 110% to the adder price

**Brodart Creative**  
**2009 Brodart Furniture - List Prices**

Catalog Number	List Price	Description
<b>End of Range Signage</b>		
64-100-S00	\$ 132.00	Label Holder for Shelving - Top (Oak Wood)
64-101-S00	\$ 116.00	Label Holder for Shelving End Panel (Oak Wood)
<b>Entrances, Appliques, Panels</b>		
BC-ENT-EL	\$ 163.00 per sq ft	Engraved laminate
BC-ENT-SS	\$ 187.00 per sq ft	Solid Surface, Square, Eased Edge w/ Satin Finish (Standard)
BC-ENT-SU	\$ 309.00 per sq ft	Solid Surface, Square, Eased Edge w/ Satin Finish (Upgrade)
BC-ENT-PG	\$ 204.00 per sq ft	Printed Graphic
BC-ENT-RD	\$ 306.00 per sq ft	Raised Decorative Theme
BC-ENT-TA	\$ 143.00 per sq ft	Transparent Graphic on Acrylic
BC-ENT-WF	\$ 102.00 per linear ft	Framing (Hardwood)
BC-ENT-SB	\$ 3,259.00 per linear ft	Sculpted Bas-Relief Entrance
BC-ENT-FR	\$ 4,074.00 per linear ft	3D - Full Round Entrance
<b>Display</b>		
BC-DIS-DC	\$ 22,407.00	Vitrine Show Wall Display Center
BC-DIS-DW	\$ 7,334.00	Vitrine Show Wall Display Wing (4')
BC-DIS-WL	\$ 1,222.00	Vitrine Show Wall Lights (2)
BC-DIS-ND	\$ 44,407.00	Nested Display
BC-DIS-DG	\$ 163.00 per sq ft	Modular Frame and Panel System - Display Graphic
BC-DIS-SF	\$ 163.00 per linear ft	Modular Frame and Panel System - 2" Square Frame
<b>Information Kiosk</b>		
BC-INK-SA	\$ 32,593.00	Stand Alone, 4 Sided (basic)
<b>Technical Furniture</b>		
BC-TEC-DT	\$ 6,926.00	Table - Dimensional, 42" Dia w/ Molded Edge
BC-TEC-CT	\$ 7,334.00	Table w/ Post-Industrial Recycled Cast Material (Optional)
BC-TEC-AW	\$ 9,778.00	Computer Workstation, Aluminum
<b>Speciality Seating</b>		
BC-SST-CB	\$ 23,629.00	2 Person Bench - Cement (Outdoor)
BC-SST-EB	\$ 28,519.00	2 Person Bench - Cement/Epoxy (Outdoor)
BC-SST-FB	\$ 29,741.00	2 Person Bench - Statuary Grade Masonry Finish (Indoor)
BC-SST-AB	\$ 14,666.00	ABC Blocks, Three Seater & Book Table
BC-SST-SE	\$ 65,185.00	Focal Point Seating Environment
<b>Custom Creation Design</b>		
BC-CCD-HR	\$ 306.00 per hr	Custom Creation Design



Catalog Number	List Price	Description
----------------	------------	-------------

---

**Grid System - Metal**

Pricing is per 36"W section. Other heights are available, please call for pricing.

**Grid Structure**

BC-GRID-78	\$ 1,714.00	each	Metal Grid System - 1 1/2" x 36" x 78"H
BC-GRID-90	\$ 1,857.00	each	Metal Grid System - 1 1/2" x 36" x 90"H

**Graphic Panel Inserts - Stock Art**

BC-GDAR-SLD	\$ 804.00	Stock Art*	Solid color acrylic panels, opaque or translucent
BC-GDAR-GOA	\$ 982.00	Stock Art*	Graphic art on translucent acrylic panels, one side
BC-GDAR-GOW	\$ 1,071.00	Stock Art*	Graphic art on wood panels, one side, finished wood on back panel

\* custom art is available at additional cost - call for pricing

**Computer Desk Attachment**

Standard finish includes laminate top and two side panels

BC-GDAD-ADA	\$ 1,625.00	each	ADA desk height attachment, 30"H
BC-GDAD-BHT	\$ 1,759.00	each	Bar height attachment, 42"H

**Desk Attachment Options**

BC-GDAD-ACS	\$ 223.00	per unit	Optional, single color acrylic sides, laminate top
BC-GDAD-SST	\$ 1,206.00	per unit	Solid surface top and sides, standard grade

**Packing for grid system**

\$ 358.00	1-4 units
\$ 72.00	each additional

**Brodart Creative**  
**Wayfinding Signage**  
**2009 Brodart Furniture - List Prices**

Catalog Number	List Price	Description
----------------	------------	-------------

**Dimensional Appliqué - 34" H x 25" W x 1" D**

Two-sided dimensional appliqué with original art graphic, raised letters.

BC-DAS-2S	\$ 4,659.00	Two-Sided
BC-DAS-1S	\$ 3,960.00	One-Sided

\*Price includes up to 12 letters per side, standard artwork. Additional charge of \$21 per extra letter.



**Blade Sign - 31" H x 7" W x 2" D**

Two-sided, blade sign consisting of wood, laminate, and acrylic letters. Can also hang from the top.

BC-BS-2S	\$ 2,859.00	Two-Sided
BC-BS-1S	\$ 2,573.00	One-Sided

\*Price includes up to 7 letters per side. Additional charge of \$28 per extra letter.

Different laminate and letter colors available.



**3-D Pop Up Book - 36" H x 36" W x 12" D**

3-D pop up book with illustrated art.

BC-WAY-PU	\$ 7,835.00	3-D Sign
-----------	-------------	----------



**Wood Framed Sign - 35" H x 11 1/2" W x 1" D**

Two-sided sign with wood frame, laminate colored inserts, brushed metal face, and routed letters.

BC-WAY-WD2	\$ 3,812.00	Two-Sided
BC-WAY-WD	\$ 3,430.00	One-Sided

\*Price includes up to 8 letters per side. Additional charge of \$21 per extra letter.

Solid surface and custom acrylic panels are available at additional cost.



**Textile Inlay - 34 1/2" H x 12 1/2" W x 1" D**

Two-sided sign made with stained wood, textured laminate, acrylic, and raised letters.

BC-TIS-2S	\$ 3,812.00	Two-Sided
BC-TIS-1S	\$ 3,621.00	One-Sided

\*Price includes up to 9 letters per side. Additional charge of \$21 per extra letter.



**Brushed Metal Laminate - 32" H x 6 1/2" W x 1" D**

Two-sided sign made with brushed metal laminate and routed letters.

BC-BML-2S	\$ 2,541.00	Two-Sided
BC-BML-1S	\$ 2,415.00	One-Sided

\*Price includes up to 9 letters per side. Additional charge of \$21 per extra letter.



**All signs are available in a larger size at an additional cost.**  
**Discounts are available for multiple signs of the same style.**

<b>Contemporary End Panel</b>					
Width					
Height		11.5"	21.5"	25.5"	40" A-Frame
	42-48"	\$1,726	\$2,502	\$2,706	N/A
	49-60"	\$2,137	\$3,039	\$3,333	\$4,235
	61-84"	\$2,918	\$3,969	\$4,353	\$4,647

**Contemporary: Framed Maple\* Veneer panel with 1/2" raised printed graphic appliqué**

<b>Traditional End Panel</b>					
Width					
Height		11.5"	21.5"	25.5"	40" A-Frame
	42-48"	\$1,961	\$3,078	\$3,137	N/A
	49-60"	\$2,421	\$3,627	\$3,804	\$5,020
	61-84"	\$3,333	\$4,745	\$4,980	\$5,431

**Traditional: Framed Maple\* Veneer panel with 1/2" raised printed maple veneer graphic appliqué**

\*Other veneers available. Please call for pricing.

<b>Euro-Core Flat</b>					
Width					
Height		11.5"	21.5"	25.5"	40" A-Frame
	42-48"	\$1,153	\$1,922	\$2,275	N/A
	49-60"	\$1,439	\$2,353	\$2,706	\$4,000
	61-84"	\$1,922	\$3,294	\$3,490	\$4,473

**3/4" Euro-core panel with printed graphic**

<b>Euro-Core Raised</b>					
Width					
Height		11.5"	21.5"	25.5"	40" A-Frame
	42-48"	\$1,314	\$2,392	\$2,588	N/A
	49-60"	\$1,745	\$2,941	\$3,216	\$4,588
	61-84"	\$2,333	\$4,118	\$4,471	\$5,294

**3/4" Euro-core panel with raised 1/2" printed graphic appliqué**

Prices quoted are for a minimum order of five (5) panels of the same style and size. Add 10% for a smaller quantity.  
 Sustainable Bamboo panels are now available. Add 10% to appropriate style.  
 Custom artwork, graphics, illustration is available for a design fee of four hundred twenty-five (\$425) dollars per design.  
 Reproductions of historic photos are three hundred eighty-one (\$381) dollars per photograph for scans and programming.  
 Prices are F.O.B. Pinellas Park, FL 33781

**Circulation Desks**  
**Circulation Desk Reference Guide**  
**2009 Brodart Furniture - List Prices**

XX-008-S00

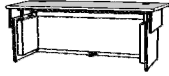

Power Adjustable  
Island Desk

XX-009-S00

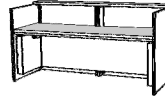

Power Adjustable In-  
Line Desk w/ PSL

XX-010-S00  
XX-E10-S00



Multipurpose Corner  
Unit

XX-011-S00  
XX-E11-S00  
Double Wide Desk  
w/ PSL

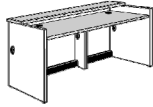

XX-011-SEA

Double Wide Desk w/  
PSL and W.S. at 28"  
H

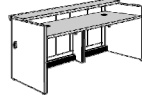

XX-012-S00  
XX-E12-S00  
Single Wide Desk w/  
PSL

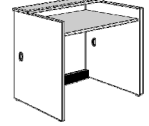

XX-013-S00  
XX-E13-S00  
Double Wide Desk

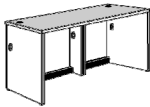

XX-014-S00  
XX-E14-S00  
Single Wide Desk

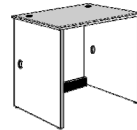

XX-015-S00  
XX-E15-S00  
Book Return Unit

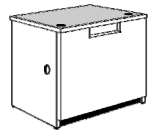

XX-016-S00  
XX-E16-S00  
90 Degree Closed  
Corner Unit

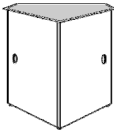

XX-017-S00  
XX-E17-S00  
Multipurpose Corner  
Unit w/ PSL

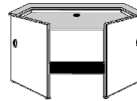

XX-018-S00  
XX-E18-S00  
45 Degree Closed  
Corner Unit

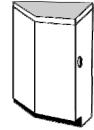

XX-040-S00  
XX-E40-S00  
90 Degree Curved  
Open Corner Unit w/  
PSL

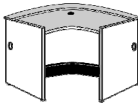

XX-041-S00  
XX-E41-S00  
90 Degree Curved  
Open Corner Unit

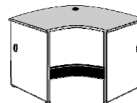

XX-143-S00  
XX-E43-S00  
90 Degree Open  
Corner Unit-Single  
Wide X 32"H

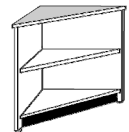

XX-044-S00  
XX-E44-S00  
Computer  
Workstation w/  
Recessed Monitor



XX-047-S00  
XX-E47-S00  
60 Degree Curved  
Open Corner Unit w/  
PSL

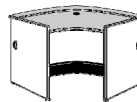

XX-048-S00  
XX-E48-S00  
60 Degree Curved  
Open Corner Unit

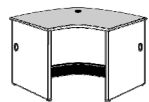

XX-055-S00  
XX-E55-S00  
90 Degree Curved  
Closed Corner Unit

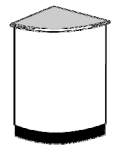

XX-058-S00  
XX-E58-S00  
45 Degree Curved  
Closed Corner Unit



XX-121-S00  
XX-E21-S00  
Disc Drive Storage and  
Open Shelf Unit



XX-122-S00  
  
Disc Drive Storage  
and Full Width  
Drawer Unit





XX-123-S00  
XX-E23-S00  
Drawer and Cupboard  
Unit





XX-124-S00  
XX-E24-S00  
Drawer and Open  
Shelf Unit

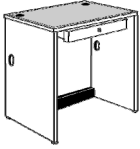
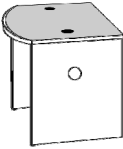

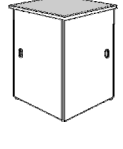
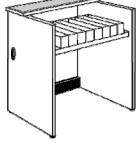

**Circulation Desks**  
**Circulation Desk Reference Guide**  
**2009 Brodart Furniture - List Prices**

XX-131-S00 XX-E31-S00		XX-E32-S00  ADA Patron Transaction Station		XX-133-S00  Desk w/ Full Width Drawer	
--------------------------	---	---	---	--	---

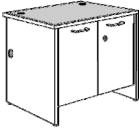
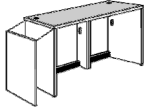
XX-135-S00  Cupboard Unit w/ Full Width Drawer		XX-150-S00 XX-E50-S00  Square Corner Unit		XX-172-S00 XX-E72-S00  Discharge Unit	
---	---	--	---	--	---

XX-174-S00 XX-E74-S00  Open Shelf Unit		XX-176-S00 XX-E76-S00 Cupboard Unit		XX-178-S00 XX-E78-S00 Detachable End Panels (pair)	
---	---	---	---	---	---

XX-234-S00* XX-E34-S00 Open Shelf Unit w/Drawer		XX-236-S00 XX-E36-S00 CD/DVD Storage unit with Drawers		XX-E37-S00  Double Pedestal Work Desk	
--	--	---	--	--	---

XX-238-S00* XX-E38-S00 Single Pedestal Work Desk					
---	---	--	--	--	--

\* XX-234 and XX-238 units in Maxim series are XX-134 and XX-138 respectively the series you are working with.

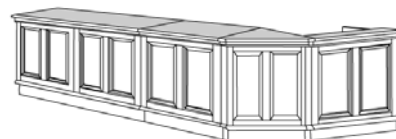
**Berwyn Collection (Prices Shown in Cherry Wood)****Circulation Desks****2009 Brodart Furniture - List Prices**

Catalog Number	List Price	Description	Weight (lbs)
----------------	------------	-------------	--------------

**Circulation Desk Units, Standing Height, 39" High**

66-008-S00	\$ 10,605.00	Power Adjustable Island Desk	390
66-009-S00	\$ 7,718.00	Power Adjustable In-Line Desk w/PSL	380
66-011-S00	\$ 5,231.00	Double Wide Desk w/PSL	245
66-011-SEA	\$ 5,242.00	Double Wide Desk w/PSL and W.S. at 28"H	245
66-012-S00	\$ 3,176.00	Single Wide Desk w/PSL	140
66-013-S00	\$ 4,570.00	Double Wide Desk	230
66-014-S00	\$ 2,781.00	Single Wide Desk	135
66-015-S00	\$ 3,133.00	Book Return Unit	135
66-044-S00	\$ 5,696.00	Computer Workstation w/Recessed Monitor	185
66-121-S00	\$ 6,251.00	Disc Drive Storage and Open Shelf Unit	175
66-122-S00	\$ 7,278.00	Disc Drive Storage and Full Width Drawer Unit	225
66-123-S00	\$ 7,322.00	Drawer and Cupboard Unit	225
66-124-S00	\$ 6,869.00	Drawer and Open Shelf Unit	200
66-131-S00	\$ 3,341.00	Desk w/ Cash Drawer	150
66-133-S00	\$ 3,765.00	Desk w/ Full Width Drawer	160
66-135-S00	\$ 5,748.00	Cupboard Unit w/ Full Width Drawer	220
66-172-S00	\$ 4,677.00	Discharge Unit	165
66-174-S00	\$ 3,147.00	Open Shelf Unit	175
66-176-S00	\$ 4,325.00	Cupboard Unit	200
66-178-S00	\$ 3,212.00	Detachable End Panels (Pair)	50
66-234-S00	\$ 3,844.00	Open Shelf Unit w/ Full Width Drawer	180
66-236-S00	\$ 5,009.00	CD/DVD Storage Unit	225
66-238-S00	\$ 7,702.00	Single Pedestal Work Desk	250

**Circulation Desk Corner Units, Standing Height, 39" High**

66-010-S00	\$ 7,889.00	Multipurpose Corner Unit	250
66-016-S00	\$ 3,319.00	90 Degree Closed Corner Unit	140
66-017-S00	\$ 9,759.00	Multipurpose Corner Unit w/PSL	245
66-018-S00	\$ 3,319.00	45 Degree Closed Corner Unit	130
66-143-S00	\$ 3,169.00	90 Degree Open Corner Unit	140
66-150-S00	\$ 4,834.00	Square Corner Unit	160

**Please specify Wood Finish and Plastic Laminate. Details can be found in the Product Options section at the front of this Price List.**

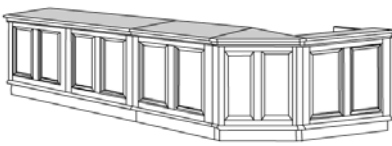

**Berwyn Collection (Prices Shown in Cherry Wood)**

**Circulation Desks**

**2009 Brodart Furniture - List Prices**

Catalog Number	List Price	Description	Weight (lbs)
<b>Circulation Desk Units, Sitting Height, 32" High</b>			
66-E11-S00	\$ 4,433.00	Double Wide Desk w/PSL	210
66-E12-S00	\$ 2,795.00	Single Wide Desk w/PSL	125
66-E13-S00	\$ 4,052.00	Double Wide Desk	195
66-E14-S00	\$ 2,486.00	Single Wide Desk	120
66-E15-S00	\$ 2,824.00	Book Return Unit	120
66-E21-S00	\$ 5,432.00	Disc Drive Storage and Open Shelf Unit	160
66-E23-S00	\$ 6,372.00	Drawer and Cupboard Unit	205
66-E24-S00	\$ 6,043.00	Drawer and Open Shelf Unit	180
66-E31-S00	\$ 2,989.00	Desk w/ Cash Drawer	135
66-E32-S00	\$ 2,615.00	ADA Patron Transaction Station	185
66-E34-S00	\$ 3,772.00	Open Shelf Unit w/ Full Width Drawer	165
66-E36-S00	\$ 4,675.00	CD/DVD Storage Unit	205
66-E37-S00	\$ 8,996.00	Double Pedestal Work Desk	260
66-E38-S00	\$ 6,797.00	Single Pedestal Work Desk	215
66-E44-S00	\$ 5,504.00	Computer Workstation w/Recessed Monitor	165
66-E72-S00	\$ 4,368.00	Discharge Unit	145
66-E74-S00	\$ 2,737.00	Open Shelf Unit	155
66-E76-S00	\$ 3,765.00	Cupboard Unit	180
66-E78-S00	\$ 2,759.00	Detachable End Panels (Pair)	50
<b>Circulation Desk Corner Units, Sitting Height, 32" High</b>			
66-E10-S00	\$ 7,357.00	Multipurpose Corner Unit	215
66-E16-S00	\$ 3,115.00	90 Degree Closed Corner Unit	120
66-E17-S00	\$ 9,240.00	Multipurpose Corner Unit w/PSL	210
66-E18-S00	\$ 3,117.00	45 Degree Closed Corner Unit	110
66-E43-S00	\$ 3,011.00	90 Degree Open Corner Unit	120
66-E50-S00	\$ 4,179.00	Square Corner Unit	140

**Please specify Wood Finish and Plastic Laminate. Details can be found in the Product Options section at the front of this Price List.**

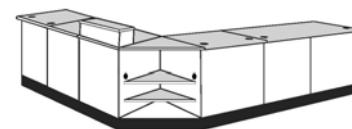
**Calista (prices shown in Oak wood)****Circulation Desks****2009 Brodart Furniture - List Prices**

Catalog Number	List Price	Description	Weight (lbs)
<b>Circulation Desk Units, Standing Height, 39" High</b>			
CLST-013-S00	\$ 2,230.00	Double Wide Open Unit, Starter, 68-1/4" W x 39" H	230
CLAD-013-S00	\$ 1,925.00	Double Wide Open Unit, Adder, 67-1/2" W x 39" H	215
CLST-014-S00	\$ 1,370.00	Single Wide Open Unit, Starter, 34-1/2" W x 39" H	135
CLAD-014-S00	\$ 1,065.00	Single Wide Open Unit, Adder, 33-3/4" W x 39" H	120
CLST-015-S00	\$ 1,475.00	Book Return Unit, Starter	135
CLAD-015-S00	\$ 1,170.00	Book Return Unit, Adder	120
<b>Circulation Desk Corner Units, Standing Height, 39" High</b>			
CLST-016-S00	\$ 1,866.00	Closed Corner Unit, Starter, 39" H	145
CLAD-016-S00	\$ 1,560.00	Closed Corner Unit, Adder, 39" H	130
CLST-143-S00	\$ 1,983.00	Open Corner Unit, Starter, 39" H	140
CLAD-143-S00	\$ 1,678.00	Open Corner Unit, Adder, 39" H	125
CLST-150-S00	\$ 2,002.00	Square Corner Unit, Starter, 39" H	145
CLAD-150-S00	\$ 1,697.00	Square Corner Unit, Adder, 39" H	130
<b>Circulation Desk Units, Sitting Height, 32" High</b>			
CLST-E13-S00	\$ 2,055.00	Double Wide Open Unit, Starter, 68-1/4" W x 32" H	195
CLAD-E13-S00	\$ 1,796.00	Double Wide Open Unit, Adder, 67-1/2" W x 32" H	180
CLST-E14-S00	\$ 1,245.00	Single Wide Open Unit, Starter, 34-1/2" W x 32" H	120
CLAD-E14-S00	\$ 986.00	Single Wide Open Unit, Adder, 33-3/4" W x 32" H	105
CLST-E15-S00	\$ 1,340.00	Book Return Unit, Starter	120
CLAD-E15-S00	\$ 1,080.00	Book Return Unit, Adder	105
CLST-E32-S00	\$ 1,450.00	ADA Patron Transaction Station, Starter, 34-1/2" W, 32" H	185
CLAD-E32-S00	\$ 1,191.00	ADA Patron Transaction Station, Adder, 33-3/4" W x 32" H	170
<b>Circulation Desk Corner Units, Sitting Height, 32" High</b>			
CLST-E16-S00	\$ 1,744.00	Closed Corner Unit, Starter, 32" H	145
CLAD-E16-S00	\$ 1,485.00	Closed Corner Unit, Adder, 32" H	130
CLST-E43-S00	\$ 1,902.00	Open Corner Unit, Starter, 32" H	120
CLAD-E43-S00	\$ 1,642.00	Open Corner Unit, Adder, 32" H	105
CLST-E50-S00	\$ 1,878.00	Square Corner Unit, Starter, 32" H	145
CLAD-E50-S00	\$ 1,619.00	Square Corner Unit, Adder, 32" H	130

**Please specify Wood Finish and Plastic Laminate. Details can be found in the Product Options section at the front of this Price List.**



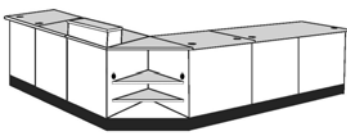

**Calista (prices shown in Oak wood)**  
**Circulation Desks**  
**2009 Brodart Furniture - List Prices**

Catalog Number	List Price	Description	Weight (lbs)
<b>Accessories*</b>			
CLSW-133-S00	\$ 701.00	Full Width Knee Space Drawer Kit, Drawer Only	45
CLSW-137-S00	\$ 1,201.00	3-Drawer Pedestal Kit, For 39" H Unit	170
CLSW-174-S00	\$ 452.00	Open Shelf Unit Kit	30
CLSW-176-S00	\$ 1,075.00	Cupboard Unit Kit, For 39" H Unit	30
CLL-178-S00	\$ 419.00	Left End Panel Only, 39" H	26
CLR-178-S00	\$ 419.00	Right End Panel Only, 39" H	26
CLT-178-S00	\$ 324.00	Transition Panel High to Low, 39" H	5
CLSW-196-S00	\$ 339.00	Patron Ledge Single Wide	25
CLDW-197-S00	\$ 455.00	Patron Ledge Double Wide	45
CLSW-E37-S00	\$ 1,072.00	2-Drawer Pedestal Kit, For 32" H Unit	150
CLSW-E74-S00	\$ 333.00	Open Shelf Unit Kit	20
CLSW-E76-S00	\$ 930.00	Cupboard Unit Kit, For 32" H Unit	30
CLL-E78-S00	\$ 366.00	Left End Panel Only, 32" H	21
CLR-E78-S00	\$ 366.00	Right End Panel Only, 32" H	21
CLT-E78-S00	\$ 324.00	Transition Panel Low to High, 32" H	5

\* Please see "Accessories for Circulation Desks" section for all other accessories

**Please specify Wood Finish and Plastic Laminate. Details can be found in the Product Options section at the front of this Price List.**

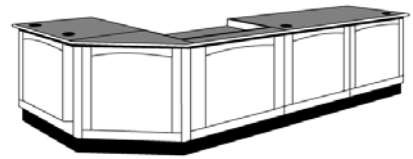
**Chancellor's Collection (Prices Shown In Oak Wood)****Circulation Desks****2009 Brodart Furniture - List Prices**

Catalog Number	List Price	Description	Weight (lbs)
----------------	------------	-------------	--------------

**Circulation Desk Units, Standing Height, 39" High**

CH2-008-S00	\$ 9,813.00	Power Adjustable Island Desk	390
CH2-009-S00	\$ 7,671.00	Power Adjustable In-Line Desk w/PSL	380
CH2-011-S00	\$ 3,943.00	Double Wide Desk w/PSL	245
CH2-011-SEA	\$ 4,170.00	Double Wide Desk w/PSL and W.S. at 28"H	245
CH2-012-S00	\$ 2,732.00	Single Wide Desk w/PSL	140
CH2-013-S00	\$ 3,775.00	Double Wide Desk	230
CH2-014-S00	\$ 2,432.00	Single Wide Desk	135
CH2-015-S00	\$ 2,367.00	Book Return Unit	135
CH2-044-S00	\$ 5,183.00	Computer Workstation w/Recessed Monitor	185
CH2-121-S00	\$ 4,310.00	Disc Drive Storage and Open Shelf Unit	175
CH2-122-S00	\$ 5,770.00	Disc Drive Storage and Full Width Drawer Unit	225
CH2-123-S00	\$ 5,151.00	Drawer and Cupboard Unit	225
CH2-124-S00	\$ 4,779.00	Drawer and Open Shelf Unit	200
CH2-131-S00	\$ 3,371.00	Desk w/ Cash Drawer	150
CH2-133-S00	\$ 3,456.00	Desk w/ Full Width Drawer	160
CH2-135-S00	\$ 3,801.00	Cupboard Unit w/ Full Width Drawer	220
CH2-172-S00	\$ 3,593.00	Discharge Unit	165
CH2-174-S00	\$ 2,771.00	Open Shelf Unit	175
CH2-176-S00	\$ 3,351.00	Cupboard Unit	200
CH2-178-S00	\$ 1,806.00	Detachable End Panels (Pair)	50
CH2-234-S00	\$ 3,286.00	Open Shelf Unit w/ Full Width Drawer	180
CH2-236-S00	\$ 4,565.00	CD/DVD Storage Unit	225
CH2-238-S00	\$ 5,366.00	Single Pedestal Work Desk	250

**Circulation Desk Corner Units, Standing Height, 39" High**

CH2-010-S00	\$ 6,559.00	Multipurpose Corner Unit	250
CH2-016-S00	\$ 2,986.00	90 Degree Closed Corner Unit	140
CH2-017-S00	\$ 8,561.00	Multipurpose Corner Unit w/PSL	245
CH2-018-S00	\$ 2,986.00	45 Degree Closed Corner Unit	130
CH2-040-S00	\$ 10,588.00	90 Degree Curved Open Corner Unit w/PSL	245
CH2-041-S00	\$ 9,376.00	90 Degree Curved Open Corner Unit	245
CH2-047-S00	\$ 12,323.00	60 Degree Curved Open Corner Unit w/PSL	245
CH2-048-S00	\$ 11,117.00	60 Degree Curved Open Corner Unit	245
CH2-055-S00	\$ 4,792.00	90 Degree Curved Closed Corner Unit	140
CH2-058-S00	\$ 4,792.00	45 Degree Curved Closed Corner Unit	130
CH2-143-S00	\$ 2,999.00	90 Degree Open Corner Unit	140
CH2-150-S00	\$ 3,475.00	Square Corner Unit	160

**Please specify Wood Finish and Plastic Laminate. Details can be found in the Product Options section at the front of this Price List.**

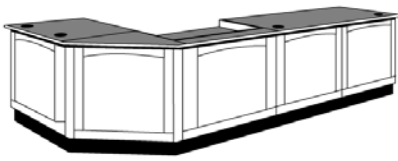

**Chancellor's Collection (Prices Shown In Oak Wood)**

**Circulation Desks**

**2009 Brodart Furniture - List Prices**

Catalog Number	List Price	Description	Weight (lbs)
<b>Circulation Desk Units, Sitting Height, 32" High</b>			
CH2-E11-S00	\$ 3,945.00	Double Wide Desk w/PSL	210
CH2-E12-S00	\$ 2,601.00	Single Wide Desk w/PSL	125
CH2-E13-S00	\$ 3,599.00	Double Wide Desk	195
CH2-E14-S00	\$ 2,249.00	Single Wide Desk	120
CH2-E15-S00	\$ 2,243.00	Book Return Unit	120
CH2-E21-S00	\$ 4,036.00	Disc Drive Storage and Open Shelf Unit	160
CH2-E23-S00	\$ 4,707.00	Drawer and Cupboard Unit	205
CH2-E24-S00	\$ 4,381.00	Drawer and Open Shelf Unit	180
CH2-E31-S00	\$ 3,227.00	Desk w/ Cash Drawer	135
CH2-E32-S00	\$ 2,532.00	ADA Patron Transaction Station	185
CH2-E34-S00	\$ 3,097.00	Open Shelf Unit w/ Full Width Drawer	165
CH2-E36-S00	\$ 4,231.00	CD/DVD Storage Unit	205
CH2-E37-S00	\$ 7,945.00	Double Pedestal Work Desk	260
CH2-E38-S00	\$ 5,079.00	Single Pedestal Work Desk	215
CH2-E44-S00	\$ 5,007.00	Computer Workstation w/Recessed Monitor	185
CH2-E72-S00	\$ 3,410.00	Discharge Unit	145
CH2-E74-S00	\$ 2,497.00	Open Shelf Unit	155
CH2-E76-S00	\$ 3,201.00	Cupboard Unit	180
CH2-E78-S00	\$ 1,597.00	Detachable End Panels (Pair)	42
<b>Circulation Desk Units, Sitting Height, 32" High</b>			
CH2-E10-S00	\$ 6,227.00	Multipurpose Corner Unit	215
CH2-E16-S00	\$ 2,882.00	90 Degree Closed Corner Unit	120
CH2-E17-S00	\$ 8,130.00	Multipurpose Corner Unit w/PSL	210
CH2-E18-S00	\$ 2,882.00	45 Degree Closed Corner Unit	110
CH2-E40-S00	\$ 9,982.00	90 Degree Curved Open Corner Unit w/PSL	210
CH2-E41-S00	\$ 8,835.00	90 Degree Curved Open Corner Unit	210
CH2-E43-S00	\$ 2,869.00	90 Degree Open Corner Unit	120
CH2-E47-S00	\$ 11,671.00	60 Degree Curved Open Corner Unit w/PSL	210
CH2-E48-S00	\$ 10,543.00	60 Degree Curved Open Corner Unit	210
CH2-E50-S00	\$ 3,306.00	Square Corner Unit	140
CH2-E55-S00	\$ 4,460.00	90 Degree Curved Closed Corner Unit	120
CH2-E58-S00	\$ 4,460.00	45 Degree Curved Closed Corner Unit	110

**Please specify Wood Finish and Plastic Laminate. Details can be found in the Product Options section at the front of this Price List.**

**Epoch Collection (prices shown in Maple Wood and PAINTED metal)**

**Circulation Desks**

**2009 Brodart Furniture - List Prices**

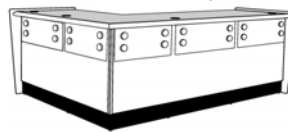

Catalog Number	List Price	Catalog Number	List Price	Description	Weight (lbs)
<b>Circulation Desk Units, Standing Height, 39" High</b>					
<b>Glass fronts</b>			<b>Metal "T" Front</b>		
59-008-S02	\$ 11,545.00	59C-008-S02	\$ 10,973.00	Power Adjustable Island Desk	390
59-009-S02	\$ 9,329.00	59C-009-S02	\$ 8,756.00	Power Adjustable In-Line Desk w/PSL	380
59-011-S02	\$ 5,601.00	59C-011-S02	\$ 5,028.00	Double Wide Desk w/PSL	245
59-011-SE2	\$ 5,612.00	59C-011-SE2	\$ 5,037.00	Double Wide Desk w/PSL and W.S. at 28"H	245
59-012-S02	\$ 3,244.00	59C-012-S02	\$ 2,958.00	Single Wide Desk w/PSL	140
59-013-S02	\$ 5,506.00	59C-013-S02	\$ 4,934.00	Double Wide Desk	230
59-014-S02	\$ 3,130.00	59C-014-S02	\$ 2,843.00	Single Wide Desk	135
59-015-S02	\$ 3,609.00	59C-015-S02	\$ 3,322.00	Book Return Unit	135
59-044-S02	\$ 4,111.00	59C-044-S02	\$ 3,824.00	Computer Workstation w/Recessed Monitor	185
59-121-S02	\$ 4,552.00	59C-121-S02	\$ 4,265.00	Disc Drive Storage and Open Shelf Unit	175
59-122-S02	\$ 5,615.00	59C-122-S02	\$ 5,329.00	Disc Drive Storage and Full Width Drawer Unit	225
59-123-S02	\$ 5,751.00	59C-123-S02	\$ 5,463.00	Drawer and Cupboard Unit	225
59-124-S02	\$ 5,227.00	59C-124-S02	\$ 4,940.00	Drawer and Open Shelf Unit	200
59-131-S02	\$ 3,517.00	59C-131-S02	\$ 3,230.00	Desk w/ Cash Drawer	150
59-133-S02	\$ 3,745.00	59C-133-S02	\$ 3,458.00	Desk w/ Full Width Drawer	160
59-135-S02	\$ 4,758.00	59C-135-S02	\$ 4,472.00	Cupboard Unit w/ Full Width Drawer	220
59-172-S02	\$ 4,827.00	59C-172-S02	\$ 4,539.00	Discharge Unit	165
59-174-S02	\$ 3,780.00	59C-174-S02	\$ 3,494.00	Open Shelf Unit	175
59-176-S02	\$ 4,405.00	59C-176-S02	\$ 4,118.00	Cupboard Unit	200
59-178-S00	\$ 1,650.00			Detachable End Panels (Pair)	50
59-236-S02	\$ 5,935.00	59C-236-S02	\$ 5,538.00	CD/DVD Storage Unit	225
59-234-S02	\$ 4,272.00	59C-234-S02	\$ 3,986.00	Open Shelf Unit w/ Full Width Drawer	180
59-238-S02	\$ 7,490.00	59C-238-S02	\$ 6,917.00	Single Pedestal Work Desk	250

**Circulation Desk Units, Standing Height, 39" High**

59-010-S02	\$ 9,211.00	59C-010-S02	\$ 8,507.00	Multipurpose Corner Unit	250
59-040-S02	\$ 11,895.00	59C-040-S02	\$ 10,570.00	90 Degree Curved Open Corner Unit w/PSL	275
59-041-S02	\$ 11,618.00	59C-041-S02	\$ 10,293.00	90 Degree Curved Open Corner Unit	275
59-047-S02	\$ 13,713.00	59C-047-S02	\$ 12,625.00	60 Degree Curved Open Corner Unit w/PSL	275
59-048-S02	\$ 13,221.00	59C-048-S02	\$ 12,132.00	60 Degree Curved Open Corner Unit	275
59-150-S02	\$ 6,368.00	59C-150-S02	\$ 5,796.00	Square Corner Unit	160

**Please specify Wood Finish, Plastic Laminate, Metal Color, and Glass (if applicable). Details can be found in the Product Options section at the front of this Price List.**

**Epoch Collection (prices shown in Maple Wood and PAINTED metal)**

**Circulation Desks**

**2009 Brodart Furniture - List Prices**

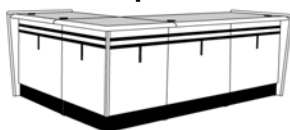
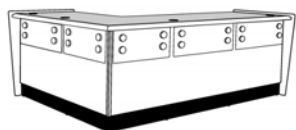

Catalog Number	List Price	Catalog Number	List Price	Description	Weight (lbs)
----------------	------------	----------------	------------	-------------	--------------

**Circulation Desk Units, Sitting Height, 32" High**

**Glass Fronts**

**Metal "T" Front**

59-E11-S02	\$ 5,260.00	59C-E11-S02	\$ 4,686.00	Double Wide Desk w/PSL	210
59-E12-S02	\$ 3,014.00	59C-E12-S02	\$ 2,728.00	Single Wide Desk w/PSL	125
59-E13-S02	\$ 5,240.00	59C-E13-S02	\$ 4,667.00	Double Wide Desk	195
59-E14-S02	\$ 2,975.00	59C-E14-S02	\$ 2,689.00	Single Wide Desk	120
59-E15-S02	\$ 3,411.00	59C-E15-S02	\$ 3,125.00	Book Return Unit	120
59-E21-S02	\$ 4,075.00	59C-E21-S02	\$ 3,789.00	Disc Drive Storage and Open Shelf Unit	160
59-E23-S02	\$ 4,991.00	59C-E23-S02	\$ 4,705.00	Drawer and Cupboard Unit	205
59-E24-S02	\$ 4,613.00	59C-E24-S02	\$ 4,326.00	Drawer and Open Shelf Unit	180
59-E31-S02	\$ 3,343.00	59C-E31-S02	\$ 3,057.00	Desk w/ Cash Drawer	135
59-E32-S00	\$ 2,536.00			ADA Patron Transaction Station	185
59-E34-S02	\$ 3,974.00	59C-E34-S02	\$ 3,688.00	Open Shelf w/ Drawer	165
59-E36-S02	\$ 5,521.00	59C-E36-S02	\$ 5,124.00	CD/DVD Storage Unit	205
59-E37-S02	\$ 8,385.00	59C-E37-S02	\$ 8,104.00	Double Pedestal Work Desk	260
59-E38-S02	\$ 6,969.00	59C-E38-S02	\$ 6,396.00	Single Pedestal Work Desk	215
59-E44-S02	\$ 3,905.00	59C-E44-S02	\$ 3,619.00	Computer Workstation w/Recessed Monitor	165
59-E72-S02	\$ 4,602.00	59C-E72-S02	\$ 4,316.00	Discharge Unit	145
59-E74-S02	\$ 3,447.00	59C-E74-S02	\$ 3,160.00	Open Shelf Unit	155
59-E76-S02	\$ 4,055.00	59C-E76-S02	\$ 3,769.00	Cupboard Unit	180
59-E78-S00	\$ 1,402.00			Detachable End Panels (Pair)	50

**Circulation Desk Corner Units, Sitting Height, 32" High**

59-E10-S02	\$ 9,109.00	59C-E10-S02	\$ 8,401.00	Multipurpose Corner Unit	250
59-E40-S02	\$ 11,764.00	59C-E40-S02	\$ 10,439.00	90 Degree Curved Open Corner Unit w/PSL	240
59-E41-S02	\$ 11,449.00	59C-E41-S02	\$ 10,138.00	90 Degree Curved Open Corner Unit	240
59-E47-S02	\$ 13,560.00	59C-E47-S02	\$ 12,472.00	60 Degree Curved Open Corner Unit w/PSL	240
59-E48-S02	\$ 13,068.00	59C-E48-S02	\$ 11,979.00	60 Degree Curved Open Corner Unit	240
59-E50-S02	\$ 5,258.00	59C-E50-S02	\$ 4,685.00	Square Corner Unit	140

**Please specify Wood Finish, Plastic Laminate, Metal Color, and Glass (if applicable). Details can be found in the Product Options section at the front of this Price List.**

**Epoch Collection (prices shown in Maple Wood and CHROME metal)**

**Circulation Desks**

**2009 Brodart Furniture - List Prices**

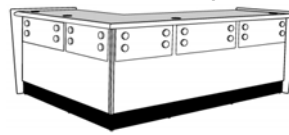

Catalog Number	List Price	Catalog Number	List Price	Description	Weight (lbs)
----------------	------------	----------------	------------	-------------	--------------

**Circulation Desk Units, Standing Height, 39" High**

Glass fronts		Metal "T" Front			
59-008-S00	\$ 12,469.00	59C-008-S00	\$ 13,168.00	Power Adjustable Island Desk	390
59-009-S00	\$ 10,075.00	59C-009-S00	\$ 10,507.00	Power Adjustable In-Line Desk w/PSL	380
59-011-S00	\$ 6,049.00	59C-011-S00	\$ 6,034.00	Double Wide Desk w/PSL	245
59-011-SEA	\$ 6,061.00	59C-011-SEA	\$ 6,045.00	Double Wide Desk w/PSL and W.S. at 28"H	245
59-012-S00	\$ 3,503.00	59C-012-S00	\$ 3,549.00	Single Wide Desk w/PSL	140
59-013-S00	\$ 5,947.00	59C-013-S00	\$ 5,921.00	Double Wide Desk	230
59-014-S00	\$ 3,380.00	59C-014-S00	\$ 3,411.00	Single Wide Desk	135
59-015-S00	\$ 3,898.00	59C-015-S00	\$ 3,987.00	Book Return Unit	135
59-044-S00	\$ 4,440.00	59C-044-S00	\$ 4,588.00	Computer Workstation w/Recessed Monitor	185
59-121-S00	\$ 4,916.00	59C-121-S00	\$ 5,118.00	Disc Drive Storage and Open Shelf Unit	175
59-122-S00	\$ 6,064.00	59C-122-S00	\$ 6,395.00	Disc Drive Storage and Full Width Drawer Unit	225
59-123-S00	\$ 6,211.00	59C-123-S00	\$ 6,556.00	Drawer and Cupboard Unit	225
59-124-S00	\$ 5,645.00	59C-124-S00	\$ 5,928.00	Drawer and Open Shelf Unit	200
59-131-S00	\$ 3,798.00	59C-131-S00	\$ 3,876.00	Desk w/ Cash Drawer	150
59-133-S00	\$ 4,045.00	59C-133-S00	\$ 4,149.00	Desk w/ Full Width Drawer	160
59-135-S00	\$ 5,139.00	59C-135-S00	\$ 5,367.00	Cupboard Unit w/ Full Width Drawer	220
59-172-S00	\$ 5,213.00	59C-172-S00	\$ 5,447.00	Discharge Unit	165
59-174-S00	\$ 4,082.00	59C-174-S00	\$ 4,192.00	Open Shelf Unit	175
59-176-S00	\$ 4,757.00	59C-176-S00	\$ 4,941.00	Cupboard Unit	200
59-178-S00	\$ 1,650.00			Detachable End Panels (Pair)	50
59-234-S00	\$ 4,614.00	59C-234-S00	\$ 4,783.00	Open Shelf Unit w/ Full Width Drawer	180
59-236-S00	\$ 6,410.00	59C-236-S00	\$ 6,645.00	CD/DVD Storage Unit	225
59-238-S00	\$ 8,089.00	59C-238-S00	\$ 8,300.00	Single Pedestal Work Desk	250

**Circulation Desk Units, Standing Height, 39" High**

59-010-S00	\$ 9,947.00	59C-010-S00	\$ 10,209.00	Multipurpose Corner Unit	250
59-040-S00	\$ 12,847.00	59C-040-S00	\$ 12,684.00	90 Degree Curved Open Corner Unit w/PSL	275
59-041-S00	\$ 12,548.00	59C-041-S00	\$ 12,351.00	90 Degree Curved Open Corner Unit	275
59-047-S00	\$ 14,810.00	59C-047-S00	\$ 15,149.00	60 Degree Curved Open Corner Unit w/PSL	275
59-048-S00	\$ 14,279.00	59C-048-S00	\$ 14,559.00	60 Degree Curved Open Corner Unit	275
59-150-S00	\$ 6,877.00	59C-150-S00	\$ 6,955.00	Square Corner Unit	160

**Please specify Wood Finish, Plastic Laminate, and Glass (if applicable). Details can be found in the Product Options section at the front of this Price List.**

**Epoch Collection (prices shown in Maple Wood and CHROME metal)**

**Circulation Desks**

**2009 Brodart Furniture - List Prices**

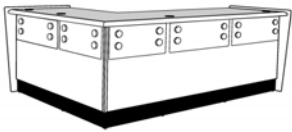

Catalog Number	List Price	Catalog Number	List Price	Description	Weight (lbs)
----------------	------------	----------------	------------	-------------	--------------

**Circulation Desk Units, Sitting Height, 32" High**

<b>Glass Fronts</b>		<b>Metal "T" Front</b>			
59-E11-S00	\$ 5,680.00	59C-E11-S00	\$ 5,624.00	Double Wide Desk w/PSL	210
59-E12-S00	\$ 3,255.00	59C-E12-S00	\$ 3,274.00	Single Wide Desk w/PSL	125
59-E13-S00	\$ 5,659.00	59C-E13-S00	\$ 5,600.00	Double Wide Desk	195
59-E14-S00	\$ 3,213.00	59C-E14-S00	\$ 3,227.00	Single Wide Desk	120
59-E15-S00	\$ 3,684.00	59C-E15-S00	\$ 3,751.00	Book Return Unit	120
59-E21-S00	\$ 4,401.00	59C-E21-S00	\$ 4,547.00	Disc Drive Storage and Open Shelf Unit	160
59-E23-S00	\$ 5,390.00	59C-E23-S00	\$ 5,646.00	Drawer and Cupboard Unit	205
59-E24-S00	\$ 4,983.00	59C-E24-S00	\$ 5,192.00	Drawer and Open Shelf Unit	180
59-E31-S00	\$ 3,611.00	59C-E31-S00	\$ 3,669.00	Desk w/ Cash Drawer	135
59-E32-S00	\$ 2,536.00			ADA Patron Transaction Station	185
59-E34-S00	\$ 4,292.00	59C-E34-S00	\$ 4,426.00	Open Shelf w/ Drawer	165
59-E36-S00	\$ 5,964.00	59C-E36-S00	\$ 6,149.00	CD/DVD Storage Unit	205
59-E37-S00	\$ 9,056.00	59C-E37-S00	\$ 9,724.00	Double Pedestal Work Desk	260
59-E38-S00	\$ 7,526.00	59C-E38-S00	\$ 7,675.00	Single Pedestal Work Desk	215
59-E44-S00	\$ 4,217.00	59C-E44-S00	\$ 4,343.00	Computer Workstation w/Recessed Monitor	165
59-E72-S00	\$ 4,970.00	59C-E72-S00	\$ 5,179.00	Discharge Unit	145
59-E74-S00	\$ 3,723.00	59C-E74-S00	\$ 3,792.00	Open Shelf Unit	155
59-E76-S00	\$ 4,380.00	59C-E76-S00	\$ 4,523.00	Cupboard Unit	180
59-E78-S00	\$ 1,402.00			Detachable End Panels (Pair)	50

**Circulation Desk Corner Units, Sitting Height, 32" High**

59-E10-S00	\$ 9,838.00	59C-E10-S00	\$ 10,082.00	Multipurpose Corner Unit	250
59-E40-S00	\$ 12,705.00	59C-E40-S00	\$ 12,527.00	90 Degree Curved Open Corner Unit w/PSL	240
59-E41-S00	\$ 12,365.00	59C-E41-S00	\$ 12,166.00	90 Degree Curved Open Corner Unit	240
59-E47-S00	\$ 14,645.00	59C-E47-S00	\$ 14,966.00	60 Degree Curved Open Corner Unit w/PSL	240
59-E48-S00	\$ 14,113.00	59C-E48-S00	\$ 14,375.00	60 Degree Curved Open Corner Unit	240
59-E50-S00	\$ 5,679.00	59C-E50-S00	\$ 5,622.00	Square Corner Unit	140

**Please specify Wood Finish, Plastic Laminate, and Glass (if applicable). Details can be found in the Product Options section at the front of this Price List.**

## Horizons Collection (prices shown in Maple wood)

### Circulation Desks

#### 2009 Brodart Furniture - List Prices

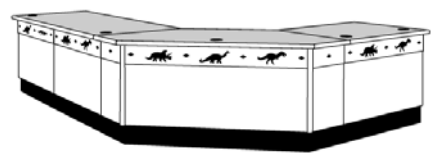

Catalog Number	List Price	Description	Weight (lbs)
<b>Circulation Desk Units, Standing Height, 39" High</b>			
77-011-S00	\$ 4,691.00	Double Wide Desk w/PSL	245
77-011-SEA	\$ 4,702.00	Double Wide Desk w/PSL and W.S. at 28"H	245
77-012-S00	\$ 3,039.00	Single Wide Desk w/PSL	140
77-013-S00	\$ 4,287.00	Double Wide Desk	230
77-014-S00	\$ 2,720.00	Single Wide Desk	135
77-015-S00	\$ 2,654.00	Book Return Unit	135
77-044-S00	\$ 3,642.00	Computer Workstation w/Recessed Monitor	165
77-121-S00	\$ 4,701.00	Disc Drive Storage and Open Shelf Unit	175
77-122-S00	\$ 6,242.00	Disc Drive Storage and Full Width Drawer Unit	225
77-123-S00	\$ 5,588.00	Drawer and Cupboard Unit	225
77-124-S00	\$ 5,200.00	Drawer and Open Shelf Unit	200
77-131-S00	\$ 3,704.00	Desk w/ Cash Drawer	150
77-133-S00	\$ 3,794.00	Desk w/ Full Width Drawer	160
77-135-S00	\$ 4,158.00	Cupboard Unit w/ Full Width Drawer	220
77-172-S00	\$ 3,941.00	Discharge Unit	165
77-174-S00	\$ 3,072.00	Open Shelf Unit	175
77-176-S00	\$ 3,686.00	Cupboard Unit	200
77-178-S00	\$ 2,037.00	Detachable End Panels (Pair)	50
77-234-S00	\$ 3,615.00	Open Shelf Unit w/ Full Width Drawer	180
77-236-S00	\$ 4,669.00	CD/DVD Storage Unit	225
77-238-S00	\$ 5,960.00	Single Pedestal Work Desk	250
<b>Circulation Desk Corner Units, Standing Height, 39" High</b>			
77-010-S00	\$ 7,366.00	Multipurpose Corner Unit	250
77-016-S00	\$ 3,465.00	90 Degree Closed Corner Unit	140
77-017-S00	\$ 9,483.00	Multipurpose Corner Unit w/PSL	245
77-018-S00	\$ 3,465.00	45 Degree Closed Corner Unit	130
77-143-S00	\$ 3,198.00	90 Degree Open Corner Unit (No Applique)	140
77-150-S00	\$ 3,804.00	Square Corner Unit	200

Please specify Wood Finish, Plastic Laminate, and Cut Out Design. Details can be found in the Product Options section at the front of this Price List.



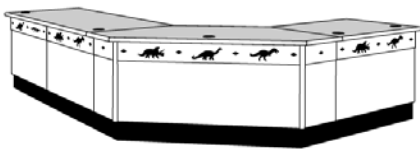

## Horizons Collection (prices shown in Maple wood)

### Circulation Desks

### 2009 Brodart Furniture - List Prices

Catalog Number	List Price	Description	Weight-lbs
<b>Circulation Desk Units, Sitting Height, 32" High</b>			
77-E11-S00	\$ 4,485.00	Double Wide Desk w/PSL	210
77-E12-S00	\$ 2,913.00	Single Wide Desk w/PSL	125
77-E13-S00	\$ 4,126.00	Double Wide Desk	195
77-E14-S00	\$ 2,496.00	Single Wide Desk	120
77-E15-S00	\$ 2,529.00	Book Return Unit	120
77-E21-S00	\$ 4,429.00	Disc Drive Storage and Open Shelf Unit	160
77-E23-S00	\$ 5,136.00	Drawer and Cupboard Unit	205
77-E24-S00	\$ 4,815.00	Drawer and Open Shelf Unit	180
77-E31-S00	\$ 4,796.00	Desk w/ Cash Drawer	135
77-E32-S00	\$ 2,496.00	ADA Patron Transaction Station	185
77-E34-S00	\$ 3,434.00	Open Shelf Unit w/ Full Width Drawer	165
77-E36-S00	\$ 4,335.00	CD/DVD Storage Unit	205
77-E37-S00	\$ 8,495.00	Double Pedestal Work Desk	260
77-E38-S00	\$ 5,690.00	Single Pedestal Work Desk	215
77-E44-S00	\$ 3,525.00	Computer Workstation w/Recessed Monitor	165
77-E72-S00	\$ 3,760.00	Discharge Unit	145
77-E74-S00	\$ 2,799.00	Open Shelf Unit	155
77-E76-S00	\$ 3,541.00	Cupboard Unit	180
77-E78-S00	\$ 1,993.00	Detachable End Panels (Pair)	42
<b>Circulation Desk Corner Units, Sitting Height, 32" High</b>			
77-E10-S00	\$ 7,053.00	Multipurpose Corner Unit	215
77-E16-S00	\$ 3,318.00	90 Degree Closed Corner Unit	120
77-E17-S00	\$ 9,064.00	Multipurpose Corner Unit w/PSL	210
77-E18-S00	\$ 3,318.00	45 Degree Closed Corner Unit	110
77-E43-S00	\$ 3,061.00	90 Degree Open Corner Unit (No Applique)	120
77-E50-S00	\$ 3,490.00	Square Corner Unit	180

**Please specify Wood Finish, Plastic Laminate, and Cut Out Design. Details can be found in the Product Options section at the front of this Price List.**

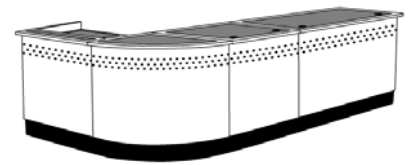
**Matrix Collection (prices shown in Maple wood)****Circulation Desks****2009 Brodart Furniture - List Prices**

Catalog Number	List Price	Description	Weight (lbs)
<b>Circulation Desk Units, Standing Height, 39" High</b>			
93-011-S00	\$ 3,860.00	Double Wide Desk w/PSL	245
93-011-SEA	\$ 3,869.00	Double Wide Desk w/PSL and W.S. at 28"H	245
93-012-S00	\$ 2,624.00	Single Wide Desk w/PSL	140
93-013-S00	\$ 3,456.00	Double Wide Desk	230
93-014-S00	\$ 2,305.00	Single Wide Desk	135
93-015-S00	\$ 2,239.00	Book Return Unit	135
93-044-S00	\$ 3,227.00	Computer Workstation w/Recessed Monitor	165
93-121-S00	\$ 4,287.00	Disc Drive Storage and Open Shelf Unit	175
93-122-S00	\$ 5,829.00	Disc Drive Storage and Full Width Drawer Unit	225
93-123-S00	\$ 5,175.00	Drawer and Cupboard Unit	225
93-124-S00	\$ 4,787.00	Drawer and Open Shelf Unit	200
93-131-S00	\$ 3,290.00	Desk w/ Cash Drawer	150
93-133-S00	\$ 3,379.00	Desk w/ Full Width Drawer	160
93-135-S00	\$ 3,744.00	Cupboard Unit w/ Full Width Drawer	220
93-172-S00	\$ 3,527.00	Discharge Unit	165
93-174-S00	\$ 2,657.00	Open Shelf Unit	175
93-176-S00	\$ 3,271.00	Cupboard Unit	200
93-178-S00	\$ 1,203.00	Detachable End Panels (Pair)	52
93-234-S00	\$ 3,200.00	Open Shelf Unit w/ Full Width Drawer	180
93-236-S00	\$ 4,561.00	CD/DVD Storage Unit	225
93-238-S00	\$ 5,129.00	Single Pedestal Work Desk	250
<b>Circulation Desk Corner Units, Standing Height, 39" High</b>			
93-010-S00	\$ 6,537.00	Multipurpose Corner Unit	250
93-016-S00	\$ 3,050.00	90 Degree Closed Corner Unit	140
93-017-S00	\$ 8,656.00	Multipurpose Corner Unit w/PSL	245
93-018-S00	\$ 3,050.00	45 Degree Closed Corner Unit	130
93-040-S00	\$ 9,662.00	90 Degree Curved Open Corner Unit w/PSL	245
93-041-S00	\$ 8,381.00	90 Degree Curved Open Corner Unit	245
93-047-S00	\$ 11,700.00	60 Degree Curved Open Corner Unit w/PSL	245
93-048-S00	\$ 10,423.00	60 Degree Curved Open Corner Unit	245
93-055-S00	\$ 3,646.00	90 Degree Curved Closed Corner Unit	140
93-058-S00	\$ 3,646.00	45 Degree Curved Closed Corner Unit	130
93-143-S00	\$ 3,200.00	90 Degree Open Corner Unit	140
93-150-S00	\$ 3,496.00	Square Corner Unit	160

**Please specify Wood Finish and Plastic Laminate. Details can be found in the Product Options section at the front of this Price List.**

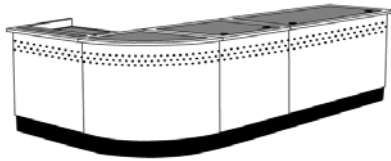

**Matrix Collection (prices shown in Maple wood)**

**Circulation Desks**

**2009 Brodart Furniture - List Prices**

Catalog Number	List Price	Description	Weight (lbs)
<b>Circulation Desk Units, Sitting Height, 32" High</b>			
93-E11-S00	\$ 3,653.00	Double Wide Desk w/PSL	210
93-E12-S00	\$ 2,498.00	Single Wide Desk w/PSL	125
93-E13-S00	\$ 3,295.00	Double Wide Desk	195
93-E14-S00	\$ 2,080.00	Single Wide Desk	120
93-E15-S00	\$ 2,113.00	Book Return Unit	120
93-E21-S00	\$ 4,016.00	Disc Drive Storage and Open Shelf Unit	160
93-E23-S00	\$ 4,723.00	Drawer and Cupboard Unit	205
93-E24-S00	\$ 4,401.00	Drawer and Open Shelf Unit	180
93-E31-S00	\$ 3,155.00	Desk w/ Cash Drawer	135
93-E32-S00	\$ 2,498.00	ADA Patron Transaction Station	185
93-E34-S00	\$ 3,020.00	Open Shelf Unit w/ Full Width Drawer	165
93-E36-S00	\$ 4,227.00	CD/DVD Storage Unit	205
93-E37-S00	\$ 7,669.00	Double Pedestal Work Desk	225
93-E38-S00	\$ 4,859.00	Single Pedestal Work Desk	215
93-E44-S00	\$ 3,111.00	Computer Workstation w/Recessed Monitor	185
93-E72-S00	\$ 3,345.00	Discharge Unit	145
93-E74-S00	\$ 2,384.00	Open Shelf Unit	155
93-E76-S00	\$ 3,126.00	Cupboard Unit	180
93-E78-S00	\$ 1,159.00	Detachable End Panels (Pair)	42
<b>Circulation Desk Corner Units, Sitting Height, 32" High</b>			
93-E10-S00	\$ 6,224.00	Multipurpose Corner Unit	215
93-E16-S00	\$ 2,903.00	90 Degree Closed Corner Unit	120
93-E17-S00	\$ 8,236.00	Multipurpose Corner Unit w/PSL	210
93-E18-S00	\$ 2,903.00	45 Degree Closed Corner Unit	110
93-E40-S00	\$ 9,192.00	90 Degree Curved Open Corner Unit w/PSL	210
93-E41-S00	\$ 7,978.00	90 Degree Curved Open Corner Unit	210
93-E43-S00	\$ 3,064.00	90 Degree Open Corner Unit	120
93-E47-S00	\$ 11,128.00	60 Degree Curved Open Corner Unit w/PSL	210
93-E48-S00	\$ 9,931.00	60 Degree Curved Open Corner Unit	210
93-E50-S00	\$ 3,182.00	Square Corner Unit	140
93-E55-S00	\$ 3,308.00	90 Degree Curved Closed Corner Unit	120
93-E58-S00	\$ 3,308.00	45 Degree Curved Closed Corner Unit	110

**Please specify Wood Finish and Plastic Laminate. Details can be found in the Product Options section at the front of this Price List.**

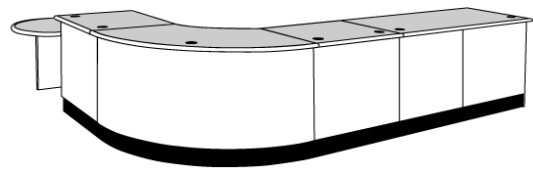
**Maxim Collection (prices shown in Oak wood)****Circulation Desks****2009 Brodart Furniture - List Prices**

Catalog Number	List Price	Description	Weight (lbs)
<b>Circulation Desk Units, Standing Height, 39" High</b>			
73-008-S00	\$ 9,080.00	Power Adjustable Island Desk	390
73-009-S00	\$ 7,151.00	Power Adjustable In-Line Desk w/PSL	380
73-011-S00	\$ 3,427.00	Double Wide Desk w/PSL	245
73-011-SEA	\$ 3,341.00	Double Wide Desk w/PSL and W.S. at 28"H	245
73-012-S00	\$ 2,370.00	Single Wide Desk w/PSL	140
73-013-S00	\$ 3,045.00	Double Wide Desk	230
73-014-S00	\$ 2,068.00	Single Wide Desk	135
73-015-S00	\$ 2,005.00	Book Return Unit	135
73-044-S00	\$ 2,940.00	Computer Workstation w/Recessed Monitor	185
73-121-S00	\$ 3,942.00	Disc Drive Storage and Open Shelf Unit	175
73-122-S00	\$ 5,399.00	Disc Drive Storage and Full Width Drawer Unit	225
73-123-S00	\$ 4,781.00	Drawer and Cupboard Unit	225
73-124-S00	\$ 4,413.00	Drawer and Open Shelf Unit	200
73-131-S00	\$ 2,999.00	Desk w/ Cash Drawer	150
73-133-S00	\$ 3,084.00	Desk w/ Full Width Drawer	160
73-134-S00	\$ 2,914.00	Open Shelf Unit w/ Full Width Drawer	180
73-135-S00	\$ 3,429.00	Cupboard Unit w/ Full Width Drawer	220
73-138-S00	\$ 4,627.00	Single Pedestal Work Desk	250
73-172-S00	\$ 3,223.00	Discharge Unit	165
73-174-S00	\$ 2,401.00	Open Shelf Unit	175
73-176-S00	\$ 2,982.00	Cupboard Unit	200
73-178-S00	\$ 917.00	Detachable End Panels (Pair)	52
73-236-S00	\$ 4,118.00	CD/DVD Storage Unit	225
<b>Circulation Desk Corner Units, Standing Height, 39" High</b>			
73-010-S00	\$ 5,956.00	Multipurpose Corner Unit	250
73-016-S00	\$ 2,773.00	90 Degree Closed Corner Unit	140
73-017-S00	\$ 7,961.00	Multipurpose Corner Unit w/PSL	245
73-018-S00	\$ 2,773.00	45 Degree Closed Corner Unit	130
73-040-S00	\$ 8,911.00	90 Degree Curved Open Corner Unit w/PSL	245
73-041-S00	\$ 7,699.00	90 Degree Curved Open Corner Unit	245
73-047-S00	\$ 10,836.00	60 Degree Curved Open Corner Unit w/PSL	245
73-048-S00	\$ 9,631.00	60 Degree Curved Open Corner Unit	245
73-055-S00	\$ 3,335.00	90 Degree Curved Closed Corner Unit	140
73-058-S00	\$ 3,335.00	45 Degree Curved Closed Corner Unit	130
73-143-S00	\$ 2,914.00	90 Degree Open Corner Unit	140
73-150-S00	\$ 2,936.00	Square Corner Unit	160

**Please specify Wood Finish and Plastic Laminate. Details can be found in the Product Options section at the front of this Price List.**

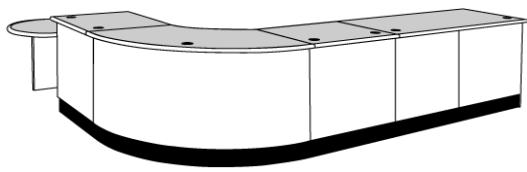

**Maxim Collection (prices shown in Oak wood)**

**Circulation Desks**

**2009 Brodart Furniture - List Prices**

Catalog Number	List Price	Description	Weight (lbs)
<b>Circulation Desk Units, Sitting Height, 32" High</b>			
73-E11-S00	\$ 3,232.00	Double Wide Desk w/PSL	210
73-E12-S00	\$ 2,250.00	Single Wide Desk w/PSL	125
73-E13-S00	\$ 2,893.00	Double Wide Desk	195
73-E14-S00	\$ 1,894.00	Single Wide Desk	120
73-E15-S00	\$ 1,887.00	Book Return Unit	120
73-E21-S00	\$ 3,684.00	Disc Drive Storage and Open Shelf Unit	160
73-E23-S00	\$ 4,353.00	Drawer and Cupboard Unit	205
73-E24-S00	\$ 4,026.00	Drawer and Open Shelf Unit	180
73-E31-S00	\$ 2,871.00	Desk w/ Cash Drawer	135
73-E32-S00	\$ 2,250.00	ADA Patron Transaction Station	185
73-E34-S00	\$ 2,743.00	Open Shelf Unit w/ Full Width Drawer	165
73-E36-S00	\$ 3,785.00	CD/DVD Storage Unit	205
73-E37-S00	\$ 7,027.00	Double Pedestal Work Desk	260
73-E38-S00	\$ 4,371.00	Single Pedestal Work Desk	215
73-E44-S00	\$ 2,829.00	Computer Workstation w/Recessed Monitor	185
73-E72-S00	\$ 3,051.00	Discharge Unit	145
73-E74-S00	\$ 2,143.00	Open Shelf Unit	155
73-E76-S00	\$ 2,845.00	Cupboard Unit	180
73-E78-S00	\$ 875.00	Detachable End Panels (Pair)	42
<b>Circulation Desk Corner Units, Sitting Height, 32" High</b>			
73-E10-S00	\$ 5,660.00	Multipurpose Corner Unit	215
73-E16-S00	\$ 2,634.00	90 Degree Closed Corner Unit	120
73-E17-S00	\$ 7,563.00	Multipurpose Corner Unit w/PSL	210
73-E18-S00	\$ 2,634.00	45 Degree Closed Corner Unit	110
73-E40-S00	\$ 8,467.00	90 Degree Curved Open Corner Unit w/PSL	210
73-E41-S00	\$ 7,319.00	90 Degree Curved Open Corner Unit	210
73-E43-S00	\$ 2,785.00	90 Degree Open Corner Unit	120
73-E47-S00	\$ 10,296.00	60 Degree Curved Open Corner Unit w/PSL	210
73-E48-S00	\$ 9,165.00	60 Degree Curved Open Corner Unit	210
73-E50-S00	\$ 2,752.00	Square Corner Unit	140
73-E55-S00	\$ 3,016.00	90 Degree Curved Closed Corner Unit	120
73-E58-S00	\$ 3,016.00	45 Degree Curved Closed Corner Unit	110

**Please specify Wood Finish and Plastic Laminate. Details can be found in the Product Options section at the front of this Price List.**

## Office Desks

Quorum 94T Collection (prices shown in Oak wood)

### 2009 Brodart Furniture - List Prices

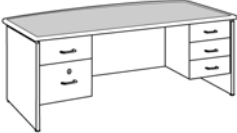
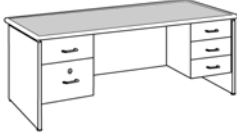
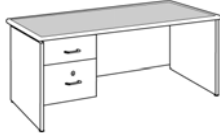
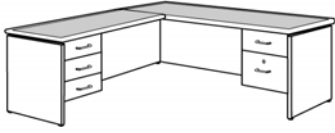
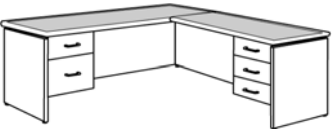
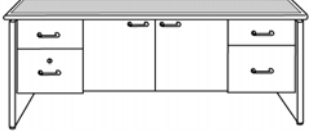
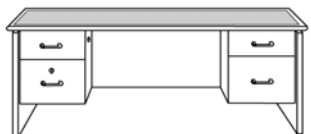
Catalog Number	List Price	Description	Weight (lbs)
<b>Administrative Office Desks and Credenzas</b>			
94T-501-S00	\$ 5,160.00	Curved Front Double Pedestal Desk, 34" x 72" x 29"H	261
			
94T-502-S00	\$ 5,005.00	Straight Front Double Pedestal Desk, 30" x 72" x 29"H	252
			
94T-503-S00	\$ 3,760.00	Straight Front Single Pedestal Desk, 30" x 48" x 29"H	210
			
94T-504-S00	\$ 5,817.00	L-Shaped-Left Return Desk, 29"H	390
			
94T-505-S00	\$ 5,817.00	L-Shaped-Right Return Desk, 29"H	390
			
94T-506-S00	\$ 5,651.00	Credenza, 25 1/4" x 71 5/8" x 29"H	285
			
94T-507-S00	\$ 4,876.00	Computer Credenza, 25 1/4" x 71 5/8" x 29"H	245
			

Please specify Wood Finish and Plastic Laminate. Details can be found in the Product Options section at the front of this Price List.



**Circulation Desk Accessories Reference Guide**  
**2009 Brodart Furniture - List Prices**

XX-464-000

Basic Keyboard  
Pullout



XX-465-000

XX-465-002  
Articulating  
Keyboard Pullout  
Swing A Mouse



XX-193-S00

XX-E93-S00  
Double Action Gate



XX-342-S00

Mobile Printer Stand



XX-914-S00

XX-914-S02  
Depressible  
Receiving Truck  
Depressible  
Receiving Truck,  
w/ Rubber  
Bumpers



XX-915-S00

XX-915-S02  
Depressible Receiving  
Truck  
Depressible  
Receiving Truck, w/  
Rubber Bumpers



XX-019-S00

XX-E19-S00  
XX-E19-S01  
Open  
Shelf/Computer  
Unit w/ Casters

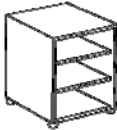

XX-020-S00

XX-E20-S00  
XX-E20-S01  
Cupboard Unit w/  
Casters

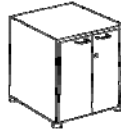

XX-021-S00

XX-E21-S00  
XX-E21-S01  
3-Drawer Unit w/  
Casters



Open  
Shelf/Computer  
Unit w/ Casters  
Open  
Shelf/Computer  
Unit w/ Casters  
Open  
Shelf/Computer Unit  
w/ Nail Glides

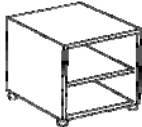

Cupboard Unit w/  
Casters



2-Drawer Unit w/  
Casters

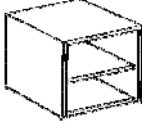
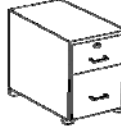

Cupboard Unit w/  
Nail Glides

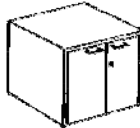

2-Drawer Unit w/  
Nail Glides

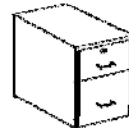



**Circulation Desks Accessories (prices shown in Oak wood)  
2009 Brodart Furniture - List Prices**

Catalog Number	List Price	Description	Weight (lbs)
<b>Keyboard Accessories</b>			
60-464-000	\$ 245.00	Basic Keyboard Pullout, Black	15
60-465-000	\$ 522.00	Articulating Keyboard Pullout, Black	13
60-465-002	\$ 222.00	Swing A Mouse, Black	2
<b>Accessories in Oak Wood</b>			
60-193-S00	\$ 1,150.00	Double Action Gate - 39" H	42
60-342-S00	\$ 1,389.00	Mobile Printer Stand	50
60-914-S00	\$ 2,709.00	Depressible Book Receiving Truck - For 32" High Unit	100
60-914-S02	\$ 2,960.00	Depressible Book Receiving Truck for 32"H Unit, w/ Rubber Bumpers	100
60-915-S00	\$ 2,709.00	Depressible Book Receiving Truck - For 39" High Unit	100
60-915-S02	\$ 2,960.00	Depressible Book Receiving Truck for 39"H Unit, w/ Rubber Bumpers	100
60-E93-S00	\$ 1,150.00	Double Action Gate, 32" H	40
TO-025-S00	\$ 425.00	Knee Space Hang-A-Drawer, without lock	18
TO-025-S02	\$ 572.00	Knee Space Hang-A-Drawer, with lock	18
<b>Mobile Pedestals</b>			
TO-019-S00	\$ 1,329.00	Open Shelf/Computer Unit w/ Casters, 33"H	115
TO-020-S00	\$ 1,710.00	Cupboard Unit w/ Casters, 33"H	120
TO-021-S00	\$ 1,835.00	3-Drawer Unit w/ Casters, 33"H	170
TO-E19-S00	\$ 1,202.00	Open Shelf/Computer Unit w/ Casters, 25-1/2"H	100
TO-E19-S01	\$ 1,202.00	Open Shelf/Computer Unit w/ Nail Glides, 23 1/4"H	100
TO-E20-S00	\$ 1,546.00	Cupboard Unit w/ Casters, 25 1/2"H	105
TO-E20-S01	\$ 1,546.00	Cupboard Unit w/ Nail Glides, 23 1/4"H	105
TO-E21-S00	\$ 1,672.00	2-Drawer Unit w/ Casters, 25 1/2"H	150
TO-E21-S01	\$ 1,672.00	2-Drawer Unit w/ Nail Glides, 23 1/4"H	150

**Please specify Wood Finish. Details can be found in the Product Options section at the front of this Price List.**

**Circulation Desks Accessories (prices shown in Maple wood)  
2009 Brodart Furniture - List Prices**

Catalog Number	List Price	Description	Weight (lbs)
<b>Keyboard Accessories</b>			
60-464-000	\$ 245.00	Basic Keyboard Pullout, Black	15
60-465-000	\$ 522.00	Articulating Keyboard Pullout, Black	13
60-465-002	\$ 222.00	Swing A Mouse, Black	2
<b>Accessories in Maple Wood</b>			
59-193-S00	\$ 1,253.00	Double Action Gate, 39"H	40
59-914-S00	\$ 2,950.00	Depressible Receiving Book Truck for 32"H Unit	100
59-914-S02	\$ 3,218.00	Depressible Receiving Book Truck for 32"H Unit, w/ Rubber Bumpers	100
59-915-S00	\$ 2,950.00	Depressible Receiving Book Truck for 39"H Unit	100
59-915-S02	\$ 3,218.00	Depressible Receiving Book Truck for 39"H Unit, w/ Rubber Bumpers	100
59-E93-S00	\$ 1,253.00	Double Action Gate, 32"H	40
MO-025-S00	\$ 463.00	Knee Space Hang-A-Drawer, without lock	25
MO-025-S02	\$ 624.00	Knee Space Hang-A-Drawer, with lock	25
MO-342-S00	\$ 1,680.00	Mobile Printer Stand	50
<b>Mobile Pedestals</b>			
MO-019-S00	\$ 1,447.00	Open Shelf/Computer Unit w/ Casters, 33"H	115
MO-020-S00	\$ 1,862.00	Cupboard Unit w/ Casters, 33"H	120
MO-021-S00	\$ 1,999.00	3-Drawer Unit w/ Casters, 33"H	170
MO-E19-S00	\$ 1,309.00	Open Shelf/Computer Unit w/ Casters, 25-1/2"H	100
MO-E19-S01	\$ 1,309.00	Open Shelf/Computer Unit w/ Nail Glides, 23 1/4"H	100
MO-E20-S00	\$ 1,682.00	Cupboard Unit w/ Casters, 25 1/2"H	105
MO-E20-S01	\$ 1,682.00	Cupboard Unit w/ Nail Glides, 23 1/4"H	105
MO-E21-S00	\$ 1,820.00	2-Drawer Unit w/ Casters, 25 1/2"H	150
MO-E21-S01	\$ 1,820.00	2-Drawer Unit w/ Nail Glides, 23 1/4"H	150

**Please specify Wood Finish. Details can be found in the Product Options section at the front of this Price List.**

**Circulation Desks Accessories (prices shown in Cherry wood)  
2009 Brodart Furniture - List Prices**

Catalog Number	List Price	Description	Weight (lbs)
<b>Keyboard Accessories</b>			
60-464-000	\$ 245.00	Basic Keyboard Pullout, Black	15
60-465-000	\$ 522.00	Articulating Keyboard Pullout, Black	13
60-465-002	\$ 222.00	Swing A Mouse, Black	2
<b>Accessories in Cherry Wood</b>			
66-193-S00	\$ 1,380.00	Double Action Gate, 39"H	42
66-342-S00	\$ 1,976.00	Mobile Printer Stand, 22"H	20
66-914-S00	\$ 3,154.00	Depressible Receiving Book Truck for 32"H Unit	100
66-914-S02	\$ 3,449.00	Depressible Receiving Book Truck for 32"H Unit, w/ Rubber Bumpers	100
66-915-S00	\$ 3,154.00	Depressible Receiving Book Truck for 39"H Unit	100
66-915-S02	\$ 3,449.00	Depressible Receiving Book Truck for 39"H Unit, w/ Rubber Bumpers	100
66-E93-S00	\$ 1,380.00	Double Action, Gate 32"H	40
CO-025-S00	\$ 489.00	Knee Space Hang-A-Drawer 25"W x 2-3/4"H	18
CO-025-S02	\$ 650.00	Knee Space Hang-A-Drawer w/ Lock	18
<b>Mobile Pedestals</b>			
CO-019-S00	\$ 1,526.00	Open Shelf/Computer Unit w/ Casters, 33"H	115
CO-020-S00	\$ 1,964.00	Cupboard Unit w/ Casters, 33"H	120
CO-021-S00	\$ 2,108.00	3-Drawer Unit w/ Casters, 33"H	170
CO-E19-S00	\$ 1,911.00	Open Shelf/Computer Unit w/ Casters, 25-1/2"H	100
CO-E19-S01	\$ 1,911.00	Open Shelf/Computer Unit w/ Nail Glides, 23 1/4"H	100
CO-E20-S00	\$ 2,374.00	Cupboard Unit w/ Casters, 25 1/2"H	105
CO-E20-S01	\$ 2,374.00	Cupboard Unit w/ Nail Glides, 23 1/4"H	105
CO-E21-S00	\$ 2,545.00	2-Drawer Unit w/ Casters, 25 1/2"H	150
CO-E21-S01	\$ 2,545.00	2-Drawer Unit w/ Nail Glides, 23 1/4"H	150

**Please specify Wood Finish. Details can be found in the Product Options section at the front of this Price List.**

**Modifications & Up Charges**  
**Circulation Desks**  
**2009 Brodart Furniture - List Prices**

Catalog Number	List Price	Description	Weight (lbs)
----------------	------------	-------------	--------------

**Replace End Panels w/ Knee Space Panels:**

\$	95.00	To order, change S00 to MOD and insert "knee panel on (left or right)" to your description	
----	-------	--	--

**Removal of Grommet and Bushing Holes from an End Panel**

\$	131.00	Per Panel	
----	--------	-----------	--

**Removal of Grommets from Work Surface**

\$	157.00	Per Work Surface	
----	--------	------------------	--

**Cut Down in Dimension of an Open Unit (i.e.: XX-014-S00)**

\$	157.00	1 Dimension Cut Down	
\$	222.00	2 Dimension Cut Down	
\$	314.00	3 Dimension Cut Down	

**Cut Down in Dimension of a Cupboard/Drawer Unit (i.e.: XX-121-S00)**

\$	314.00	1 Dimension Cut Down	
\$	445.00	2 Dimension Cut Down	
\$	575.00	3 Dimension Cut Down	

**Change Work Surface Height**

\$	157.00	Per Unit	
----	--------	----------	--

**Factory Installed Add-On Patron Ledge**

\$	288.00	Per Unit	
----	--------	----------	--

**Replace Standard Tops with Sub Tops**

\$	157.00	Per Unit	
----	--------	----------	--

**Place Continuous Tops on a Circulation Desk Unit**

\$	92.00	Per Unit - Must Use Sub Tops	
----	-------	------------------------------	--

**Change Standard HPL to Marmoleum**

10%	Per Unit		
-----	----------	--	--

**Change Standard Top/Edge Band to Corian**

Please Call for Pricing



**2be! Table Series (prices shown in Maple wood)  
Tables, Adult Height  
2009 Brodart Furniture - List Prices**

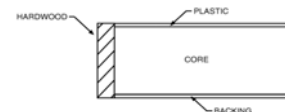

Catalog Number	List Price	Description	Weight (lbs)
2B-545-S00	\$ 1,577.00	36" Diameter Table, 29"H	100
2B-546-S00	\$ 1,652.00	42" Diameter Table, 29"H	110
2B-547-S00	\$ 1,688.00	48" Diameter Table, 29"H	120
2B-548-S00	\$ 2,013.00	60" Diameter Table, 29"H	140
2B-519-S00	\$ 1,245.00	36" Square Table, 29"H	81
2B-527-S00	\$ 1,333.00	42" Square Table, 29"H	110
2B-534-S00	\$ 1,403.00	48" Square Table, 29"H	140
2B-540-S00	\$ 1,730.00	60" Square Table, 29"H	225
2B-511-S00	\$ 1,171.00	30" x 36" Table, 29"H	70
2B-512-S00	\$ 1,197.00	30" x 42" Table, 29"H	80
2B-513-S00	\$ 1,217.00	30" x 48" Table, 29"H	90
2B-514-S00	\$ 1,341.00	30" x 60" Table, 29"H	115
2B-515-S00	\$ 1,502.00	30" x 72" Table, 29"H	135
2B-516-S00	\$ 1,770.00	30" x 90" Table, 29"H	170
2B-517-S00	\$ 1,855.00	30" x 108" Table, 29"H	202
2B-518-S00	\$ 2,460.00	30" x 144" Table, 29"H	270
2B-520-S00	\$ 1,277.00	36" x 42" Table, 29"H	94
2B-521-S00	\$ 1,308.00	36" x 48" Table, 29"H	108
2B-522-S00	\$ 1,431.00	36" x 60" Table, 29"H	135
2B-523-S00	\$ 1,624.00	36" x 72" Table, 29"H	150
2B-524-S00	\$ 1,900.00	36" x 90" Table, 29"H	210
2B-525-S00	\$ 2,007.00	36" x 108" Table, 29"H	243
2B-526-S00	\$ 2,904.00	36" x 144" Table, 29"H	324
2B-528-S00	\$ 1,367.00	42" x 48" Table, 29"H	126
2B-529-S00	\$ 1,492.00	42" x 60" Table, 29"H	157
2B-530-S00	\$ 1,709.00	42" x 72" Table, 29"H	189
2B-531-S00	\$ 1,993.00	42" x 90" Table, 29"H	220
2B-532-S00	\$ 2,133.00	42" x 108" Table, 29"H	283
2B-533-S00	\$ 3,107.00	42" x 144" Table, 29"H	278
2B-535-S00	\$ 1,533.00	48" x 60" Table, 29"H	180
2B-536-S00	\$ 1,755.00	48" x 72" Table, 29"H	216
2B-537-S00	\$ 2,046.00	48" x 90" Table, 29"H	250
2B-538-S00	\$ 2,193.00	48" x 108" Table, 29"H	324
2B-539-S00	\$ 3,218.00	48" x 144" Table, 29"H	432
2B-541-S00	\$ 2,671.00	60" x 72" Table, 29"H	270
2B-542-S00	\$ 2,880.00	60" x 90" Table, 29"H	337
2B-543-S00	\$ 3,586.00	60" x 108" Table, 29"H	405
2B-544-S00	\$ 4,689.00	60" x 144" Table, 29"H	540

**Please specify Wood Finish, Plastic Laminate, and Metal Color. Details can be found in the Product Options section at the front of this Price List.**

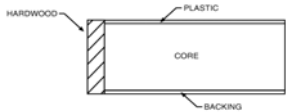

**2be! Table Series (prices shown in Maple wood)  
Tables, Youth Height  
2009 Brodart Furniture - List Prices**

Catalog Number	List Price	Description	Weight (lbs)
2B-Y45-S00	\$ 1,577.00	36" Diameter Table, 27 1/2"H	100
2B-Y46-S00	\$ 1,652.00	42" Diameter Table, 27 1/2"H	110
2B-Y47-S00	\$ 1,688.00	48" Diameter Table, 27 1/2"H	120
2B-Y48-S00	\$ 2,013.00	60" Diameter Table, 27 1/2"H	140
2B-Y19-S00	\$ 1,245.00	36" Square Table, 27 1/2"H	81
2B-Y27-S00	\$ 1,333.00	42" Square Table, 27 1/2"H	110
2B-Y34-S00	\$ 1,403.00	48" Square Table, 27 1/2"H	140
2B-Y40-S00	\$ 1,730.00	60" Square Table, 27 1/2"H	225
2B-Y11-S00	\$ 1,171.00	30" x 36" Table, 27 1/2"H	70
2B-Y12-S00	\$ 1,197.00	30" x 42" Table, 27 1/2"H	80
2B-Y13-S00	\$ 1,217.00	30" x 48" Table, 27 1/2"H	90
2B-Y14-S00	\$ 1,341.00	30" x 60" Table, 27 1/2"H	115
2B-Y15-S00	\$ 1,502.00	30" x 72" Table, 27 1/2"H	135
2B-Y16-S00	\$ 1,770.00	30" x 90" Table, 27 1/2"H	170
2B-Y17-S00	\$ 1,855.00	30" x 108" Table, 27 1/2"H	202
2B-Y18-S00	\$ 2,460.00	30" x 144" Table, 27 1/2"H	270
2B-Y20-S00	\$ 1,277.00	36" x 42" Table, 27 1/2"H	94
2B-Y21-S00	\$ 1,308.00	36" x 48" Table, 27 1/2"H	108
2B-Y22-S00	\$ 1,431.00	36" x 60" Table, 27 1/2"H	135
2B-Y23-S00	\$ 1,624.00	36" x 72" Table, 27 1/2"H	150
2B-Y24-S00	\$ 1,900.00	36" x 90" Table, 27 1/2"H	210
2B-Y25-S00	\$ 2,007.00	36" x 108" Table, 27 1/2"H	243
2B-Y26-S00	\$ 2,904.00	36" x 144" Table, 27 1/2"H	324
2B-Y28-S00	\$ 1,367.00	42" x 48" Table, 27 1/2"H	126
2B-Y29-S00	\$ 1,492.00	42" x 60" Table, 27 1/2"H	157
2B-Y30-S00	\$ 1,709.00	42" x 72" Table, 27 1/2"H	189
2B-Y31-S00	\$ 1,993.00	42" x 90" Table, 27 1/2"H	220
2B-Y32-S00	\$ 2,133.00	42" x 108" Table, 27 1/2"H	283
2B-Y33-S00	\$ 3,107.00	42" x 144" Table, 27 1/2"H	278
2B-Y35-S00	\$ 1,533.00	48" x 60" Table, 27 1/2"H	180
2B-Y36-S00	\$ 1,755.00	48" x 72" Table, 27 1/2"H	216
2B-Y37-S00	\$ 2,046.00	48" x 90" Table, 27 1/2"H	250
2B-Y38-S00	\$ 2,193.00	48" x 108" Table, 27 1/2"H	324
2B-Y39-S00	\$ 3,218.00	48" x 144" Table, 27 1/2"H	432
2B-Y41-S00	\$ 2,671.00	60" x 72" Table, 27 1/2"H	270
2B-Y42-S00	\$ 2,880.00	60" x 90" Table, 27 1/2"H	337
2B-Y43-S00	\$ 3,586.00	60" x 108" Table, 27 1/2"H	405
2B-Y44-S00	\$ 4,689.00	60" x 144" Table, 27 1/2"H	540



**Please specify Wood Finish, Plastic Laminate, and Metal Color. Details can be found in the Product Options section at the front of this Price List.**

**2be! Table Series (prices shown in Maple wood)  
Tables, Juvenile Height  
2009 Brodart Furniture - List Prices**

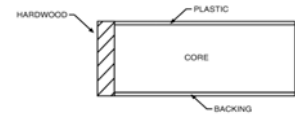

Catalog Number	List Price	Description		Weight (lbs)
2B-J45-S00	\$ 1,577.00	36" Diameter Table, 25"H		100
2B-J46-S00	\$ 1,652.00	42" Diameter Table, 25"H		110
2B-J47-S00	\$ 1,688.00	48" Diameter Table, 25"H		120
2B-J48-S00	\$ 2,013.00	60" Diameter Table, 25"H		140
2B-J19-S00	\$ 1,245.00	36" Square Table, 25"H		81
2B-J27-S00	\$ 1,333.00	42" Square Table, 25"H		110
2B-J34-S00	\$ 1,403.00	48" Square Table, 25"H		140
2B-J40-S00	\$ 1,730.00	60" Square Table, 25"H		225
2B-J11-S00	\$ 1,171.00	30" x 36" Table, 25"H		70
2B-J12-S00	\$ 1,197.00	30" x 42" Table, 25"H		80
2B-J13-S00	\$ 1,217.00	30" x 48" Table, 25"H		90
2B-J14-S00	\$ 1,341.00	30" x 60" Table, 25"H		115
2B-J15-S00	\$ 1,502.00	30" x 72" Table, 25"H		135
2B-J16-S00	\$ 1,770.00	30" x 90" Table, 25"H		170
2B-J17-S00	\$ 1,855.00	30" x 108" Table, 25"H		202
2B-J18-S00	\$ 2,460.00	30" x 144" Table, 25"H		270
2B-J20-S00	\$ 1,277.00	36" x 42" Table, 25"H		94
2B-J21-S00	\$ 1,308.00	36" x 48" Table, 25"H		108
2B-J22-S00	\$ 1,431.00	36" x 60" Table, 25"H		135
2B-J23-S00	\$ 1,624.00	36" x 72" Table, 25"H		150
2B-J24-S00	\$ 1,900.00	36" x 90" Table, 25"H		210
2B-J25-S00	\$ 2,007.00	36" x 108" Table, 25"H		243
2B-J26-S00	\$ 2,904.00	36" x 144" Table, 25"H		324
2B-J28-S00	\$ 1,367.00	42" x 48" Table, 25"H		126
2B-J29-S00	\$ 1,492.00	42" x 60" Table, 25"H		157
2B-J30-S00	\$ 1,709.00	42" x 72" Table, 25"H		189
2B-J31-S00	\$ 1,993.00	42" x 90" Table, 25"H	220	
2B-J32-S00	\$ 2,133.00	42" x 108" Table, 25"H	283	
2B-J33-S00	\$ 3,107.00	42" x 144" Table, 25"H	278	
2B-J35-S00	\$ 1,533.00	48" x 60" Table, 25"H		180
2B-J36-S00	\$ 1,755.00	48" x 72" Table, 25"H		216
2B-J37-S00	\$ 2,046.00	48" x 90" Table, 25"H		250
2B-J38-S00	\$ 2,193.00	48" x 108" Table, 25"H		324
2B-J39-S00	\$ 3,218.00	48" x 144" Table, 25"H		432
2B-J41-S00	\$ 2,671.00	60" x 72" Table, 25"H		270
2B-J42-S00	\$ 2,880.00	60" x 90" Table, 25"H	337	
2B-J43-S00	\$ 3,586.00	60" x 108" Table, 25"H	405	
2B-J44-S00	\$ 4,689.00	60" x 144" Table, 25"H	540	

**Please specify Wood Finish, Plastic Laminate, and Metal Color. Details can be found in the Product Options section at the front of this Price List.**



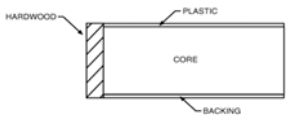

**2be! Table Series (prices shown in Maple wood)  
Tables w/ Superstructure, Adult Height  
2009 Brodart Furniture - List Prices**

Catalog Number	List Price	Description	Weight (lbs)
----------------	------------	-------------	--------------

**Tables w/ Superstructure, Adult Height, No Grommets**

2BP-550-S00	\$ 1,916.00	S/F with Superstructure, 24 x 36 x 29"H	70
2BP-551-S00	\$ 2,784.00	S/F with Superstructure, 24 x 72 x 29"H	132
2BP-552-S00	\$ 3,613.00	S/F with Superstructure, 24 x 108 x 29"H	198
2BP-553-S00	\$ 4,721.00	S/F with Superstructure, 24 x 144 x 29"H	264
2BP-554-S00	\$ 1,965.00	S/F with Superstructure, 30 x 36 x 29"H	85
2BP-555-S00	\$ 2,821.00	S/F with Superstructure, 30 x 72 x 29"H	165
2BP-556-S00	\$ 3,694.00	S/F with Superstructure, 30 x 108 x 29"H	247
2BP-557-S00	\$ 4,764.00	S/F with Superstructure, 30 x 144 x 29"H	330
2BP-558-S00	\$ 2,377.00	D/F with Superstructure, 48 x 36 x 29"H	132
2BP-559-S00	\$ 3,533.00	D/F with Superstructure, 48 x 72 x 29"H	264
2BP-560-S00	\$ 4,587.00	D/F with Superstructure, 48 x 108 x 29"H	396
2BP-561-S00	\$ 6,236.00	D/F with Superstructure, 48 x 144 x 29"H	528
2BP-563-S00	\$ 2,500.00	D/F with Superstructure, 60 x 36 x 29"H	165
2BP-564-S00	\$ 4,427.00	D/F with Superstructure, 60 x 72 x 29"H	330
2BP-565-S00	\$ 5,969.00	D/F with Superstructure, 60 x 108 x 29"H	495
2BP-566-S00	\$ 7,681.00	D/F with Superstructure, 60 x 144 x 29"H	660

**Tables w/ Superstructure, Adult Height, with Grommets**

2BPG-550-S00	\$ 1,927.00	S/F with Superstructure, 24 x 36 x 29"H	70
2BPG-551-S00	\$ 2,810.00	S/F with Superstructure, 24 x 72 x 29"H	132
2BPG-552-S00	\$ 3,640.00	S/F with Superstructure, 24 x 108 x 29"H	198
2BPG-553-S00	\$ 4,711.00	S/F with Superstructure, 24 x 144 x 29"H	264
2BPG-554-S00	\$ 1,976.00	S/F with Superstructure, 30 x 36 x 29"H	85
2BPG-555-S00	\$ 2,857.00	S/F with Superstructure, 30 x 72 x 29"H	165
2BPG-556-S00	\$ 3,736.00	S/F with Superstructure, 30 x 108 x 29"H	247
2BPG-557-S00	\$ 4,823.00	S/F with Superstructure, 30 x 144 x 29"H	330
2BPG-558-S00	\$ 2,392.00	D/F with Superstructure, 48 x 36 x 29"H	132
2BPG-559-S00	\$ 3,544.00	D/F with Superstructure, 48 x 72 x 29"H	264
2BPG-560-S00	\$ 4,623.00	D/F with Superstructure, 48 x 108 x 29"H	396
2BPG-561-S00	\$ 6,286.00	D/F with Superstructure, 48 x 144 x 29"H	528
2BPG-563-S00	\$ 2,515.00	D/F with Superstructure, 60 x 36 x 29"H	165
2BPG-564-S00	\$ 4,460.00	D/F with Superstructure, 60 x 72 x 29"H	330
2BPG-565-S00	\$ 6,016.00	D/F with Superstructure, 60 x 108 x 29"H	495
2BPG-566-S00	\$ 7,757.00	D/F with Superstructure, 60 x 144 x 29"H	660

**Please specify Wood Finish, Plastic Laminate, Metal Color, End/Intermediate Panel, Top & Bottom Shelf, and Back Panel/Top Cap. Details can be found in the Product Options section at the front of this Price List.**

## 2be! Table Series (prices shown in Maple wood)

### Tables w/ Superstructure, Youth Height

#### 2009 Brodart Furniture - List Prices

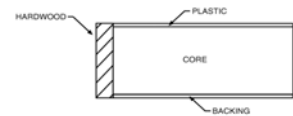





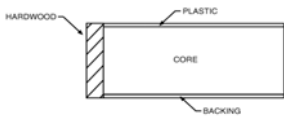



Catalog Number	List Price	Description	Weight (lbs)
<b>Tables w/ Superstructure, Youth Height, No Grommets</b>			
2BP-Y50-S00	\$ 1,916.00	S/F with Superstructure, 24 x 36 x 27 1/2"H	70
2BP-Y51-S00	\$ 2,784.00	S/F with Superstructure, 24 x 72 x 27 1/2"H	132
2BP-Y52-S00	\$ 3,613.00	S/F with Superstructure, 24 x 108 x 27 1/2"H	198
2BP-Y53-S00	\$ 4,721.00	S/F with Superstructure, 24 x 144 x 27 1/2"H	264
2BP-Y54-S00	\$ 1,965.00	S/F with Superstructure, 30 x 36 x 27 1/2"H	85
2BP-Y55-S00	\$ 2,821.00	S/F with Superstructure, 30 x 72 x 27 1/2"H	165
2BP-Y56-S00	\$ 3,694.00	S/F with Superstructure, 30 x 108 x 27 1/2"H	247
2BP-Y57-S00	\$ 4,764.00	S/F with Superstructure, 30 x 144 x 27 1/2"H	330
2BP-Y58-S00	\$ 2,377.00	D/F with Superstructure, 48 x 36 x 27 1/2"H	132
2BP-Y59-S00	\$ 3,533.00	D/F with Superstructure, 48 x 72 x 27 1/2"H	264
2BP-Y60-S00	\$ 4,587.00	D/F with Superstructure, 48 x 108 x 27 1/2"H	396
2BP-Y61-S00	\$ 6,236.00	D/F with Superstructure, 48 x 144 x 27 1/2"H	528
2BP-Y63-S00	\$ 2,500.00	D/F with Superstructure, 60 x 36 x 27 1/2"H	165
2BP-Y64-S00	\$ 4,427.00	D/F with Superstructure, 60 x 72 x 27 1/2"H	330
2BP-Y65-S00	\$ 5,969.00	D/F with Superstructure, 60 x 108 x 27 1/2"H	495
2BP-Y66-S00	\$ 7,681.00	D/F with Superstructure, 60 x 144 x 27 1/2"H	660
<b>Tables w/ Superstructure, Youth Height, with Grommets</b>			
2BPG-Y50-S00	\$ 1,927.00	S/F with Superstructure, 24 x 36 x 27 1/2"H	70
2BPG-Y51-S00	\$ 2,810.00	S/F with Superstructure, 24 x 72 x 27 1/2"H	132
2BPG-Y52-S00	\$ 3,640.00	S/F with Superstructure, 24 x 108 x 27 1/2"H	198
2BPG-Y53-S00	\$ 4,711.00	S/F with Superstructure, 24 x 144 x 27 1/2"H	264
2BPG-Y54-S00	\$ 1,976.00	S/F with Superstructure, 30 x 36 x 27 1/2"H	85
2BPG-Y55-S00	\$ 2,857.00	S/F with Superstructure, 30 x 72 x 27 1/2"H	165
2BPG-Y56-S00	\$ 3,736.00	S/F with Superstructure, 30 x 108 x 27 1/2"H	247
2BPG-Y57-S00	\$ 4,823.00	S/F with Superstructure, 30 x 144 x 27 1/2"H	330
2BPG-Y58-S00	\$ 2,392.00	D/F with Superstructure, 48 x 36 x 27 1/2"H	132
2BPG-Y59-S00	\$ 3,544.00	D/F with Superstructure, 48 x 72 x 27 1/2"H	264
2BPG-Y60-S00	\$ 4,623.00	D/F with Superstructure, 48 x 108 x 27 1/2"H	396
2BPG-Y61-S00	\$ 6,286.00	D/F with Superstructure, 48 x 144 x 27 1/2"H	528
2BPG-Y63-S00	\$ 2,515.00	D/F with Superstructure, 60 x 36 x 27 1/2"H	165
2BPG-Y64-S00	\$ 4,460.00	D/F with Superstructure, 60 x 72 x 27 1/2"H	330
2BPG-Y65-S00	\$ 6,016.00	D/F with Superstructure, 60 x 108 x 27 1/2"H	495
2BPG-Y66-S00	\$ 7,757.00	D/F with Superstructure, 60 x 144 x 27 1/2"H	660

Please specify Wood Finish, Plastic Laminate, Metal Color, End/Intermediate Panel, Top & Bottom Shelf, and Back Panel/Top Cap. Details can be found in the Product Options section at the front of this Price List.



**2be! Table Series (prices shown in Maple wood)  
Tables w/ Superstructure, Juvenile Height  
2009 Brodart Furniture - List Prices**

Catalog Number	List Price	Description		Weight (lbs)
<b>Tables w/ Superstructure, Juvenile Height, with Grommets</b>				
2BPG-J50-S00	\$ 1,927.00	S/F with Superstructure, 24 x 36 x 25"H		70
2BPG-J51-S00	\$ 2,810.00	S/F with Superstructure, 24 x 72 x 25"H		132
2BPG-J52-S00	\$ 3,640.00	S/F with Superstructure, 24 x 108 x 25"H		198
2BPG-J53-S00	\$ 4,711.00	S/F with Superstructure, 24 x 144 x 25"H		264
2BPG-J54-S00	\$ 1,976.00	S/F with Superstructure, 30 x 36 x 25"H		85
2BPG-J55-S00	\$ 2,857.00	S/F with Superstructure, 30 x 72 x 25"H		165
2BPG-J56-S00	\$ 3,736.00	S/F with Superstructure, 30 x 108 x 25"H		247
2BPG-J57-S00	\$ 4,823.00	S/F with Superstructure, 30 x 144 x 25"H		330
2BPG-J58-S00	\$ 2,392.00	D/F with Superstructure, 48 x 36 x 25"H		132
2BPG-J59-S00	\$ 3,544.00	D/F with Superstructure, 48 x 72 x 25"H		264
2BPG-J60-S00	\$ 4,623.00	D/F with Superstructure, 48 x 108 x 25"H		396
2BPG-J61-S00	\$ 6,286.00	D/F with Superstructure, 48 x 144 x 25"H		528
2BPG-J63-S00	\$ 2,515.00	D/F with Superstructure, 60 x 36 x 25"H		165
2BPG-J64-S00	\$ 4,460.00	D/F with Superstructure, 60 x 72 x 25"H		330
2BPG-J65-S00	\$ 6,016.00	D/F with Superstructure, 60 x 108 x 25"H		495
2BPG-J66-S00	\$ 7,757.00	D/F with Superstructure, 60 x 144 x 25"H		660
<b>Tables w/ Superstructure, Juvenile Height, No Grommets</b>				
2BP-J50-S00	\$ 1,916.00	S/F with Superstructure, 24 x 36 x 25"H		70
2BP-J51-S00	\$ 2,784.00	S/F with Superstructure, 24 x 72 x 25"H		132
2BP-J52-S00	\$ 3,613.00	S/F with Superstructure, 24 x 108 x 25"H		198
2BP-J53-S00	\$ 4,721.00	S/F with Superstructure, 24 x 144 x 25"H		264
2BP-J54-S00	\$ 1,965.00	S/F with Superstructure, 30 x 36 x 25"H		85
2BP-J55-S00	\$ 2,821.00	S/F with Superstructure, 30 x 72 x 25"H		165
2BP-J56-S00	\$ 3,694.00	S/F with Superstructure, 30 x 108 x 25"H		247
2BP-J57-S00	\$ 4,764.00	S/F with Superstructure, 30 x 144 x 25"H		330
2BP-J58-S00	\$ 2,377.00	D/F with Superstructure, 48 x 36 x 25"H		132
2BP-J59-S00	\$ 3,533.00	D/F with Superstructure, 48 x 72 x 25"H		264
2BP-J60-S00	\$ 4,587.00	D/F with Superstructure, 48 x 108 x 25"H		396
2BP-J61-S00	\$ 6,236.00	D/F with Superstructure, 48 x 144 x 25"H		528
2BP-J63-S00	\$ 2,500.00	D/F with Superstructure, 60 x 36 x 25"H		165
2BP-J64-S00	\$ 4,427.00	D/F with Superstructure, 60 x 72 x 25"H		330
2BP-J65-S00	\$ 5,969.00	D/F with Superstructure, 60 x 108 x 25"H		495
2BP-J66-S00	\$ 7,681.00	D/F with Superstructure, 60 x 144 x 25"H		660

**Please specify Wood Finish, Plastic Laminate, Metal Color, End/Intermediate Panel, Top & Bottom Shelf, and Back Panel/Top Cap. Details can be found in the Product Options section at the front of this Price List.**

**Berwyn Collection (prices shown in Cherry wood)**

**Tables**

**2009 Brodart Furniture - List Prices**

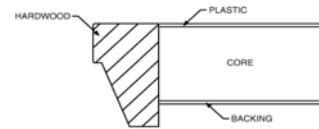

Catalog Number	List Price	Description		Weight (lbs)
<b>Tables, Leg Base</b>				
66-109-S00	\$ 2,156.00	36" Diameter, 29"H		100
66-129-S00	\$ 2,226.00	42" Diameter, 29"H		100
66-141-S00	\$ 2,226.00	48" Diameter, 29"H		100
66-130-S00	\$ 2,647.00	60" Diameter, 29"H		100
66-191-S00	\$ 1,809.00	30 3/4" Square Table, 29"H		100
66-137-S00	\$ 1,881.00	42 3/4" Square table, 29"H		100
66-154-S00	\$ 1,967.00	48 3/4" Square Table, 29"H		100
66-194-S00	\$ 2,012.00	30 3/4" X 60 3/4" Table, 29"H		110
66-195-S00	\$ 2,270.00	30 3/4" X 72 3/4" Table, 29"H		130
66-198-S00	\$ 2,587.00	30 3/4" X 90 3/4" Table, 29"H		150
66-144-S00	\$ 2,059.00	36 3/4" X 60 3/4" Table, 29"H		110
66-138-S00	\$ 2,173.00	36 3/4" X 72 3/4" Table, 29"H		130
66-146-S00	\$ 2,633.00	36 3/4" X 90 3/4" Table, 29"H		150
66-145-S00	\$ 2,460.00	48 3/4" X 72 3/4" Table, 29"H		160
66-134-S00	\$ 3,041.00	48 3/4" X 90 3/4" Table, 29"H	200	

**Please specify Wood Finish, and Plastic Laminate. Details can be found in the Product Options section at the front of this Price List.**

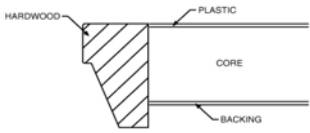

**Berwyn Collection (prices shown in Cherry wood)**

**Tables**

**2009 Brodart Furniture - List Prices**

Catalog Number	List Price	Description	Weight (lbs)
----------------	------------	-------------	--------------

**Tables, Leg Base with Apron**

66-A09-S00	\$ 2,223.00	36" Diameter, 29"H	100
66-A29-S00	\$ 2,293.00	42" Diameter, 29"H	100
66-A41-S00	\$ 2,293.00	48" Diameter, 29"H	100
66-A91-S00	\$ 1,881.00	30 3/4" Square Table, 29"H	100
66-A37-S00	\$ 1,949.00	42 3/4" Square table, 29"H	100
66-A54-S00	\$ 2,039.00	48 3/4" Square Table, 29"H	100
66-A94-S00	\$ 2,062.00	30 3/4" X 60 3/4" Table, 29"H	110
66-A95-S00	\$ 2,197.00	30 3/4" X 72 3/4" Table, 29"H	130
66-A98-S00	\$ 2,658.00	30 3/4" X 90 3/4" Table, 29"H	150
66-A44-S00	\$ 2,105.00	36 3/4" X 60 3/4" Table, 29"H	110
66-A38-S00	\$ 2,240.00	36 3/4" X 72 3/4" Table, 29"H	130
66-A46-S00	\$ 2,702.00	36 3/4" X 90 3/4" Table, 29"H	150
66-A45-S00	\$ 2,512.00	48 3/4" X 72 3/4" Table, 29"H	160
66-A34-S00	\$ 3,094.00	48 3/4" X 90 3/4" Table, 29"H	200

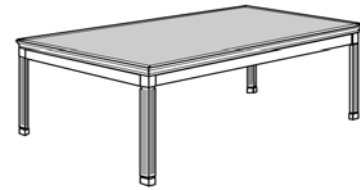

**Tables, Panel Base**

66-P44-S00	\$ 3,923.00	36 3/4" X 60 3/4" Table, Panel Base, 29"H	130
66-P38-S00	\$ 4,124.00	36 3/4" X 72 3/4" Table, Panel Base, 29"H	150
66-P46-S00	\$ 4,146.00	36 3/4" X 90 3/4" Table, Panel Base, 29"H	170
66-P45-S00	\$ 4,627.00	48 3/4" X 72 3/4" Table, Panel Base, 29"H	180
66-P34-S00	\$ 4,663.00	48 3/4" X 90 3/4" Table, Panel Base, 29"H	200

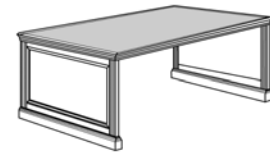

**Please specify Wood Finish, and Plastic Laminate. Details can be found in the Product Options section at the front of this Price List.**

**Chancellor's Collection (prices shown in Oak wood)**

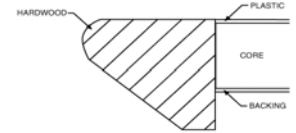

**Tables**

**2009 Brodart Furniture - List Prices**





Catalog Number	List Price	Description	Weight (lbs)
----------------	------------	-------------	--------------

**Tables, Leg Base, Chamfered Square Leg Design, Apronless**

CH2-109-S00	\$ 1,956.00	38" Diameter, 29"H		100
CH2-129-S00	\$ 2,080.00	44" Diameter, 29" H		90
CH2-141-S00	\$ 2,080.00	50" Diameter, 29" H		100
CH2-130-S00	\$ 2,650.00	62" Diameter, 29"H		110
CH2-191-S00	\$ 1,695.00	32 3/4" Square Table, 29"H		100
CH2-137-S00	\$ 1,819.00	44 3/4" Square Table, 29" H		100
CH2-154-S00	\$ 1,943.00	50 3/4" Square Table, 29"H		100
CH2-194-S00	\$ 1,852.00	32 3/4" X 62 3/4" Table, 29"H		110
CH2-195-S00	\$ 1,943.00	32 3/4" X 74 3/4" Table, 29"H		130
CH2-198-S00	\$ 2,339.00	32 3/4" X 92 3/4" Table, 29"H		150
CH2-144-S00	\$ 1,891.00	38 3/4" X 62 3/4" Table, 29"H		110
CH2-138-S00	\$ 1,982.00	38 3/4" X 74 3/4" Table, 29"H		130
CH2-146-S00	\$ 2,378.00	38 3/4" X 92 3/4" Table, 29"H		150
CH2-145-S00	\$ 2,243.00	50 3/4" X 74 3/4" Table, 29"H		160
CH2-134-S00	\$ 2,732.00	50 3/4" X 92 3/4" Table, 29"H		200

**Tables, Leg Base, Chamfered Square Leg Design, Apron Style**

CH2-A09-S00	\$ 2,054.00	38" Diameter, 29"H		100
CH2-A29-S00	\$ 2,178.00	44" Diameter, 29" H		90
CH2-A41-S00	\$ 2,178.00	50" Diameter, 29" H		100
CH2-A30-S00	\$ 2,785.00	62" Diameter, 29"H		110
CH2-A91-S00	\$ 1,786.00	32 3/4" Square Table, 29"H		100
CH2-A37-S00	\$ 1,910.00	44 3/4" Square Table, 29" H		100
CH2-A54-S00	\$ 2,034.00	50 3/4" Square Table, 29"H		100
CH2-A94-S00	\$ 1,943.00	32 3/4" X 62 3/4" Table, 29"H		110
CH2-A95-S00	\$ 2,034.00	32 3/4" X 74 3/4" Table, 29"H		130
CH2-A98-S00	\$ 2,431.00	32 3/4" X 92 3/4" Table, 29"H		150
CH2-A44-S00	\$ 1,982.00	38 3/4" X 62 3/4" Table, 29"H		110
CH2-A38-S00	\$ 2,080.00	38 3/4" X 74 3/4" Table, 29"H		130
CH2-A46-S00	\$ 2,504.00	38 3/4" X 92 3/4" Table, 29"H		150
CH2-A45-S00	\$ 2,360.00	50 3/4" X 74 3/4" Table, 29"H		160
CH2-A34-S00	\$ 2,882.00	50 3/4" X 92 3/4" Table, 29"H		200

Please specify Wood Finish, and Plastic Laminate. Details can be found in the Product Options section at the front of this Price List.

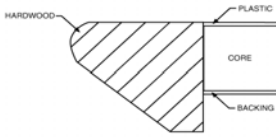

**Chancellor's Collection (prices shown in Oak wood)**

**Tables**

**2009 Brodart Furniture - List Prices**

Catalog Number	List Price	Description	Weight (lbs)
----------------	------------	-------------	--------------

**Tables, Leg Base, Traditional Round Leg Design, Apron Style**

CH2-R09-S00	\$ 2,054.00	38" Diameter, Round Legs, 29"H	100
CH-R29-S00	\$ 2,178.00	44" Diameter, Round Legs, 29" H	90
CH-R41-S00	\$ 2,178.00	50" Diameter, Round Legs, 29" H	100
CH-R30-S00	\$ 2,785.00	62" Diameter, Round Legs, 29"H	120
CH2-R91-S00	\$ 1,786.00	32 3/4" Square Table, Round Legs, 29"H	100
CH-R37-S00	\$ 1,910.00	44 3/4" Square Table, 29" H	100
CH-R54-S00	\$ 2,034.00	50 3/4" Square Table, Round Legs, 29"H	100
CH-R94-S00	\$ 1,943.00	32 3/4" X 62 3/4" Table, Round Legs, 29"H	110
CH-R95-S00	\$ 2,034.00	32 3/4" X 74 3/4" Table, Round Legs, 29"H	130
CH-R98-S00	\$ 2,431.00	32 3/4" X 92 3/4" Table, Round Legs, 29"H	150
CH-R44-S00	\$ 1,982.00	38 3/4" X 62 3/4" Table, Round Legs, 29"H	110
CH-R38-S00	\$ 2,080.00	38 3/4" X 74 3/4" Table, Round Legs, 29"H	130
CH-R46-S00	\$ 2,504.00	38 3/4" X 92 3/4" Table, Round Legs, 29"H	150
CH-R45-S00	\$ 2,360.00	50 3/4" X 74 3/4" Table, Round Legs, 29"H	160
CH-R34-S00	\$ 2,882.00	50 3/4" X 92 3/4" Table, Round Legs, 29"H	200



**Tables, Panel Base**

CH2-P44-S00	\$ 2,406.00	38 3/4" X 62 3/4" Table, Panel Base, 29"H	130
CH2-P38-S00	\$ 2,634.00	38 3/4" X 74 3/4" Table, Panel Base, 29"H	150
CH2-P46-S00	\$ 2,725.00	38 3/4" X 92 3/4" Table, Panel Base, 29"H	170
CH2-P45-S00	\$ 2,901.00	50 3/4" X 74 3/4" Table, Panel Base, 29"H	180
CH2-P34-S00	\$ 3,397.00	50 3/4" X 92 3/4" Table, Panel Base, 29"H	200



**Please specify Wood Finish, and Plastic Laminate. Details can be found in the Product Options section at the front of this Price List.**

# Epoch Collection (prices shown in Maple wood)

## Tables, Powder Coated Legs

### 2009 Brodart Furniture - List Prices

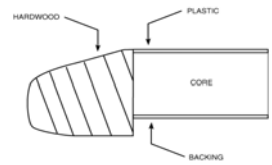





Plywood Core		Particleboard Core		Description	Weight (lbs)
Catalog Number	List Price	Catalog Number	List Price		

#### Tables - Powder Coated Legs

##### Plywood Core

##### Particleboard

59-109-S00	\$ 2,164.00	59-109-S02	\$ 2,021.00	38" Diameter, 29"H		100
59-129-S00	\$ 2,269.00	59-129-S02	\$ 2,125.00	44" Diameter, 29" H		110
59-141-S00	\$ 2,440.00	59-141-S02	\$ 2,235.00	50" Diameter, 29" H		120
N/A	\$ -	59-130-S02	\$ 2,806.00	62" Diameter, 29"H		140
59-191-S00	\$ 2,099.00	59-191-S02	\$ 1,956.00	32 3/4" Square Table, 29"H		100
59-137-S00	\$ 2,204.00	59-137-S02	\$ 2,060.00	44 3/4" Square Table, 29"H		100
59-154-S00	\$ 2,319.00	59-154-S02	\$ 2,176.00	50 3/4" Square Table, 29"H		100
59-194-S00	\$ 2,491.00	59-194-S02	\$ 2,310.00	32 3/4" X 62 3/4" Table, 29"H		120
59-195-S00	\$ 2,594.00	59-195-S02	\$ 2,424.00	32 3/4" X 74 3/4" Table, 29"H		140
59-198-S00	\$ 3,621.00	59-198-S02	\$ 3,362.00	32 3/4" X 92 3/4" Table, 29"H		160
59-144-S00	\$ 2,560.00	59-144-S02	\$ 2,380.00	38 3/4" X 62 3/4" Table, 29"H		120
59-138-S00	\$ 2,667.00	59-138-S02	\$ 2,493.00	38 3/4" X 74 3/4" Table, 29"H		140
59-146-S00	\$ 3,691.00	59-146-S02	\$ 3,431.00	38 3/4" X 92 3/4" Table, 29"H		160
59-145-S00	\$ 2,956.00	59-145-S02	\$ 2,682.00	50 3/4" X 74 3/4" Table, 29"H		170
59-134-S00	\$ 4,098.00	59-134-S02	\$ 3,709.00	50 3/4" X 92 3/4" Table, 29"H		185

**Note:** All Epoch Tables now come standard with the angle bracket cut out design.



**Please specify Wood Finish, Plastic Laminate, and Metal Color. Details can be found in the Product Options section at the front of this Price List.**



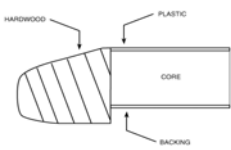

# Epoch Collection (prices shown in Maple wood)

## Tables, Wood Legs





### 2009 Brodart Furniture - List Prices

Plywood Core		Particleboard Core		Description	Weight (lbs)
Catalog Number	List Price	Catalog Number	List Price		

#### Tables - Wood legs

##### Plywood Core

##### Particleboard

59W-109-S00	\$ 2,164.00	59W-109-S02	\$ 2,021.00	38" Diameter, 29"H		100
59W-129-S00	\$ 2,269.00	59W-129-S02	\$ 2,125.00	44" Diameter, 29" H		110
59W-141-S00	\$ 2,440.00	59W-141-S02	\$ 2,235.00	50" Diameter, 29" H		120
N/A	\$ -	59W-130-S02	\$ 2,806.00	62" Diameter, 29"H		140
59W-191-S00	\$ 2,099.00	59W-191-S02	\$ 1,956.00	32 3/4" Square Table, 29"H		100
59W-137-S00	\$ 2,204.00	59W-137-S02	\$ 2,060.00	44 3/4" Square Table, 29"H		100
59W-154-S00	\$ 2,319.00	59W-154-S02	\$ 2,176.00	50 3/4" Square Table, 29"H		100
59W-194-S00	\$ 2,491.00	59W-194-S02	\$ 2,310.00	32 3/4" X 62 3/4" Table, 29"H		120
59W-195-S00	\$ 2,594.00	59W-195-S02	\$ 2,424.00	32 3/4" X 74 3/4" Table, 29"H		140
59W-198-S00	\$ 3,621.00	59W-198-S02	\$ 3,362.00	32 3/4" X 92 3/4" Table, 29"H		160
59W-144-S00	\$ 2,560.00	59W-144-S02	\$ 2,380.00	38 3/4" X 62 3/4" Table, 29"H		120
59W-138-S00	\$ 2,667.00	59W-138-S02	\$ 2,493.00	38 3/4" X 74 3/4" Table, 29"H		140
59W-146-S00	\$ 3,691.00	59W-146-S02	\$ 3,431.00	38 3/4" X 92 3/4" Table, 29"H		160
59W-145-S00	\$ 2,956.00	59W-145-S02	\$ 2,682.00	50 3/4" X 74 3/4" Table, 29"H		170
59W-134-S00	\$ 4,098.00	59W-134-S02	\$ 3,709.00	50 3/4" X 92 3/4" Table, 29"H		185

**Note:** All Epoch Tables now come standard with the angle bracket cut out design.



**Please specify Wood Finish, Plastic Laminate, and Metal Color. Details can be found in the Product Options section at the front of this Price List.**

# Epoch Collection (prices shown in Maple wood)

## Tables, Chrome

### 2009 Brodart Furniture - List Prices

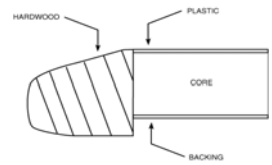





Plywood Core		Particleboard Core		Description	Weight (lbs)
Catalog Number	List Price	Catalog Number	List Price		

#### Tables - Chrome legs

##### Plywood Core

##### Particleboard

59C-109-S00	\$ 2,676.00	59C-109-S02	\$ 2,533.00	38" Diameter, 29"H		100
59C-129-S00	\$ 2,780.00	59C-129-S02	\$ 2,637.00	44" Diameter, 29" H		110
59C-141-S00	\$ 2,953.00	59C-141-S02	\$ 2,747.00	50" Diameter, 29" H		120
N/A	\$ -	59C-130-S02	\$ 3,319.00	62" Diameter, 29"H		140
59C-191-S00	\$ 2,768.00	59C-191-S02	\$ 2,469.00	32 3/4" Square Table, 29"H		100
59C-137-S00	\$ 2,872.00	59C-137-S02	\$ 2,573.00	44 3/4" Square Table, 29"H		100
59C-154-S00	\$ 2,988.00	59C-154-S02	\$ 2,689.00	50 3/4" Square Table, 29"H		100
59C-194-S00	\$ 3,027.00	59C-194-S02	\$ 2,846.00	32 3/4" X 62 3/4" Table, 29"H		120
59C-195-S00	\$ 3,137.00	59C-195-S02	\$ 2,963.00	32 3/4" X 74 3/4" Table, 29"H		140
59C-198-S00	\$ 4,433.00	59C-198-S02	\$ 4,175.00	32 3/4" X 92 3/4" Table, 29"H		160
59C-144-S00	\$ 3,096.00	59C-144-S02	\$ 2,916.00	38 3/4" X 62 3/4" Table, 29"H		120
59C-138-S00	\$ 3,207.00	59C-138-S02	\$ 3,033.00	38 3/4" X 74 3/4" Table, 29"H		140
59C-146-S00	\$ 4,502.00	59C-146-S02	\$ 4,244.00	38 3/4" X 92 3/4" Table, 29"H		160
59C-145-S00	\$ 3,466.00	59C-145-S02	\$ 3,249.00	50 3/4" X 74 3/4" Table, 29"H		170
59C-134-S00	\$ 4,911.00	59C-134-S02	\$ 4,485.00	50 3/4" X 92 3/4" Table, 29"H		185

**Note:** All Epoch Tables now come standard with the angle bracket cut out design.



**Please specify Wood Finish, and Plastic Laminate. Details can be found in the Product Options section at the front of this Price List.**



# Horizons Collection (prices shown in Maple wood)

## Tables, Adult Height, Wood Legs

### 2009 Brodart Furniture - List Prices

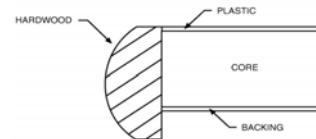

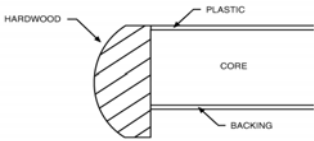

Plywood Core		Particleboard Core		Description	Weight (lbs)
Catalog Number	List Price	Catalog Number	List Price		
<b>Tables w/Wood Legs, Adult</b>					
77-109-S00	\$ 1,877.00	77-109-S02	\$ 1,799.00	36" Diameter, 29"H	
77-129-S00	\$ 1,988.00	77-129-S02	\$ 1,909.00	42" Diameter, 29"H	
77-141-S00	\$ 1,988.00	77-141-S02	\$ 1,909.00	48" Diameter, 29"H	
N/A	\$ -	77-130-S02	\$ 2,331.00	60" Diameter, 29"H	
77-191-S00	\$ 1,480.00	77-191-S02	\$ 1,345.00	30" Square Table, 29"H	
77-137-S00	\$ 1,590.00	77-137-S02	\$ 1,455.00	42" Square Table, 29"H	
77-154-S00	\$ 1,713.00	77-154-S02	\$ 1,578.00	48" Square Table, 29"H	
77-194-S00	\$ 1,750.00	77-194-S02	\$ 1,582.00	30" X 60" Table, 29"H	
77-195-S00	\$ 1,877.00	77-195-S02	\$ 1,709.00	30" X 72" Table, 29"H	
77-198-S00	\$ 2,501.00	77-198-S02	\$ 2,344.00	30" X 90" Table, 29"H	
77-144-S00	\$ 1,823.00	77-144-S02	\$ 1,655.00	36" X 60" Table, 29"H	
77-138-S00	\$ 1,951.00	77-138-S02	\$ 1,783.00	36" X 72" Table, 29"H	
77-146-S00	\$ 2,574.00	77-146-S02	\$ 2,417.00	36" X 90" Table, 29"H	
77-145-S00	\$ 2,519.00	77-145-S02	\$ 2,096.00	48" X 72" Table, 29"H	
77-134-S00	\$ 2,818.00	77-134-S02	\$ 2,634.00	48" X 90" Table, 29"H	

Please specify Wood Finish, and Plastic Laminate. Details can be found in the Product Options section at the front of this Price List.

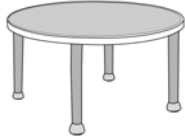

## Horizons Collection (prices shown in Maple wood)

### Tables, Adult Height, Metal Legs 2009 Brodart Furniture - List Prices

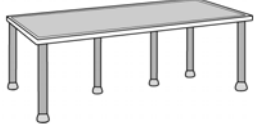
Plywood Core		Particleboard Core		Description	Weight (lbs)
Catalog Number	List Price	Catalog Number	List Price		
<b>Tables w/Metal Legs, Adult</b>					
77M-109-S00	\$ 1,975.00	77M-109-S02	\$ 1,853.00	36" Diameter, 29"H	
77M-129-S00	\$ 2,086.00	77M-129-S02	\$ 1,963.00	42" Diameter, 29"H	
77M-141-S00	\$ 2,086.00	77M-141-S02	\$ 1,963.00	48" Diameter, 29"H	
N/A	\$ -	77M-130-S02	\$ 2,356.00	60" Diameter, 29"H	
77M-191-S00	\$ 1,596.00	77M-191-S02	\$ 1,438.00	30" Square Table, 29"H	
77M-137-S00	\$ 1,707.00	77M-137-S02	\$ 1,548.00	42" Square Table, 29"H	
77M-154-S00	\$ 1,829.00	77M-154-S02	\$ 1,671.00	48" Square Table, 29"H	
77M-194-S00	\$ 1,871.00	77M-194-S02	\$ 1,676.00	30" X 60" Table, 29"H	
77M-195-S00	\$ 1,972.00	77M-195-S02	\$ 1,805.00	30" X 72" Table, 29"H	
77M-198-S00	\$ 2,501.00	77M-198-S02	\$ 2,480.00	30" X 90" Table, 29"H	
77M-144-S00	\$ 1,920.00	77M-144-S02	\$ 1,750.00	36" X 60" Table, 29"H	
77M-138-S00	\$ 2,045.00	77M-138-S02	\$ 1,879.00	36" X 72" Table, 29"H	
77M-146-S00	\$ 2,751.00	77M-146-S02	\$ 2,553.00	36" X 90" Table, 29"H	
77M-145-S00	\$ 2,614.00	77M-145-S02	\$ 2,190.00	48" X 72" Table, 29"H	
77M-134-S00	\$ 2,995.00	77M-134-S02	\$ 2,811.00	48" X 90" Table, 29"H	



Please specify Wood Finish, Plastic Laminate, and Metal Color. Details can be found in the Product Options section at the front of this Price List.

# Horizons Collection (prices shown in Maple wood)

## Tables, Youth Height, Wood Legs

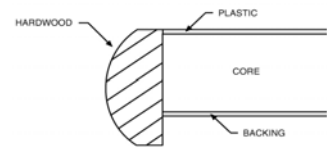
### 2009 Brodart Furniture - List Prices

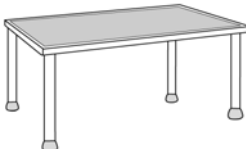
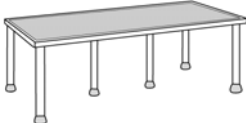

Plywood Core		Particleboard Core		Description	Weight (lbs)	
Catalog Number	List Price	Catalog Number	List Price			
<b>Tables w/Wood Legs, Youth</b>						
77-Y09-S00	\$ 1,877.00	77-Y09-S02	\$ 1,799.00	36" Diameter, 27 1/2"H		100
77-Y29-S00	\$ 1,988.00	77-Y29-S02	\$ 1,909.00	42" Diameter, 27 1/2"H		90
77-Y41-S00	\$ 1,988.00	77-Y41-S02	\$ 1,909.00	48" Diameter, 27 1/2"H		100
N/A	\$ -	77-Y30-S02	\$ 2,331.00	60" Diameter, 27 1/2"H		140
77-Y91-S00	\$ 1,480.00	77-Y91-S02	\$ 1,345.00	30" Square Table, 27 1/2"H		100
77-Y37-S00	\$ 1,590.00	77-Y37-S02	\$ 1,455.00	42" Square Table, 27 1/2"H		100
77-Y54-S00	\$ 1,713.00	77-Y54-S02	\$ 1,578.00	48" Square Table, 27 1/2"H		100
77-Y94-S00	\$ 1,750.00	77-Y94-S02	\$ 1,582.00	30" X 60" Table, 27 1/2"H		110
77-Y95-S00	\$ 1,877.00	77-Y95-S02	\$ 1,709.00	30" X 72" Table, 27 1/2"H		130
77-Y98-S00	\$ 2,501.00	77-Y98-S02	\$ 2,344.00	30" X 90" Table, 27 1/2"H		150
77-Y44-S00	\$ 1,823.00	77-Y44-S02	\$ 1,655.00	36" X 60" Table, 27 1/2"H		110
77-Y38-S00	\$ 1,951.00	77-Y38-S02	\$ 1,783.00	36" X 72" Table, 27 1/2"H		130
77-Y46-S00	\$ 2,574.00	77-Y46-S02	\$ 2,417.00	36" X 90" Table, 27 1/2"H		150
77-Y45-S00	\$ 2,519.00	77-Y45-S02	\$ 2,096.00	48" X 72" Table, 27 1/2"H		160
77-Y34-S00	\$ 2,818.00	77-Y34-S02	\$ 2,634.00	48" X 90" Table, 27 1/2"H	200	

Please specify Wood Finish, and Plastic Laminate. Details can be found in the Product Options section at the front of this Price List.

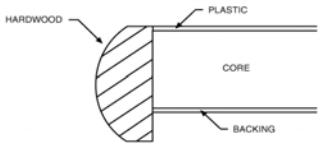

**Horizons Collection (prices shown in Maple wood)  
Tables, Youth Height, Metal Legs  
2009 Brodart Furniture - List Prices**

Plywood Core		Particleboard Core		Description	Weight (lbs)
Catalog Number	List Price	Catalog Number	List Price		
<b>Tables w/Metal Legs, Youth</b>					
77M-Y09-S00	\$ 1,975.00	77M-Y09-S02	\$ 1,853.00	36" Diameter, 27 1/2"H	
77M-Y29-S00	\$ 2,086.00	77M-Y29-S02	\$ 1,963.00	42" Diameter, 27 1/2"H	
77M-Y41-S00	\$ 2,086.00	77M-Y41-S02	\$ 1,963.00	48" Diameter, 27 1/2"H	
N/A	\$ -	77M-Y30-S02	\$ 2,356.00	60" Diameter, 27 1/2"H	
77M-Y91-S00	\$ 1,596.00	77M-Y91-S02	\$ 1,438.00	30" Square Table, 27 1/2"H	
77M-Y37-S00	\$ 1,707.00	77M-Y37-S02	\$ 1,548.00	42" Square Table, 27 1/2"H	
77M-Y54-S00	\$ 1,829.00	77M-Y54-S02	\$ 1,671.00	48" Square Table, 27 1/2"H	
77M-Y94-S00	\$ 1,871.00	77M-Y94-S02	\$ 1,676.00	30" X 60" Table, 25"H	
77M-Y95-S00	\$ 1,972.00	77M-Y95-S02	\$ 1,805.00	30" X 72" Table, 25"H	
77M-Y98-S00	\$ 2,501.00	77M-Y98-S02	\$ 2,480.00	30" X 90" Table, 25"H	
77M-Y44-S00	\$ 1,920.00	77M-Y44-S02	\$ 1,750.00	36" X 60" Table, 27 1/2"H	
77M-Y38-S00	\$ 2,045.00	77M-Y38-S02	\$ 1,879.00	36" X 72" Table, 27 1/2"H	
77M-Y46-S00	\$ 2,751.00	77M-Y45-S02	\$ 2,553.00	36" X 90" Table, 27 1/2"H	
77M-Y45-S00	\$ 2,614.00	77M-Y45-S02	\$ 2,190.00	48" X 72" Table, 27 1/2"H	
77M-Y34-S00	\$ 2,995.00	77M-Y34-S02	\$ 2,811.00	48" X 90" Table, 27 1/2"H	



**Please specify Wood Finish, Plastic Laminate, and Metal Color. Details can be found in the Product Options section at the front of this Price List.**

# Horizons Collection (prices shown in Maple wood)

## Tables, Juvenile Height, Wood Legs

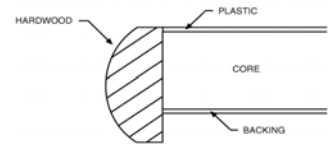
### 2009 Brodart Furniture - List Prices

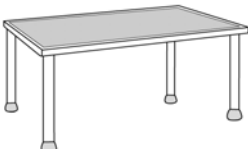
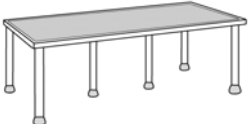
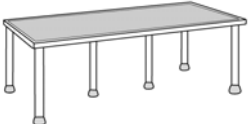

Plywood Core		Particleboard Core		Description	Weight (lbs)	
Catalog Number	List Price	Catalog Number	List Price			
<b>Tables w/Wood Legs, Juvenile</b>						
77-J09-S00	\$ 1,877.00	77-J09-S02	\$ 1,799.00	36" Diameter, 25"H		100
77-J29-S00	\$ 1,988.00	77-J29-S02	\$ 1,909.00	42" Diameter, 25"H		90
77-J41-S00	\$ 1,988.00	77-J41-S02	\$ 1,909.00	48" Diameter, 25"H		100
N/A	\$ -	77-J30-S02	\$ 2,331.00	60" Diameter, 25"H		140
77-J91-S00	\$ 1,480.00	77-J91-S02	\$ 1,345.00	30" Square Table, 25"H		100
77-J37-S00	\$ 1,590.00	77-J37-S02	\$ 1,455.00	42" Square Table, 25"H		100
77-J54-S00	\$ 1,713.00	77-J54-S02	\$ 1,578.00	48" Square Table, 25"H		100
77-J94-S00	\$ 1,750.00	77-J94-S02	\$ 1,582.00	30" X 60" Table, 25"H		110
77-J95-S00	\$ 1,877.00	77-J95-S02	\$ 1,709.00	30" X 72" Table, 25"H		130
77-J98-S00	\$ 2,501.00	77-J98-S02	\$ 2,344.00	30" X 90" Table, 25"H		150
77-J44-S00	\$ 1,823.00	77-J44-S02	\$ 1,655.00	36" X 60" Table, 25"H		110
77-J38-S00	\$ 1,951.00	77-J38-S02	\$ 1,783.00	36" X 72" Table, 25"H		130
77-J46-S00	\$ 2,574.00	77-J46-S02	\$ 2,417.00	36" X 90" Table, 25"H		150
77-J45-S00	\$ 2,519.00	77-J45-S02	\$ 2,096.00	48" X 72" Table, 25"H		160
77-J34-S00	\$ 2,818.00	77-J34-S02	\$ 2,634.00	48" X 90" Table, 25"H		200



Please specify Wood Finish, and Plastic Laminate. Details can be found in the Product Options section at the front of this Price List.

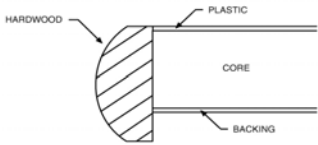



## Horizons Collection (prices shown in Maple wood)

### Tables, Juvenile Height, Metal Legs 2009 Brodart Furniture - List Prices

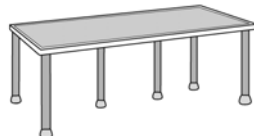
Plywood Core		Particleboard Core		Description	Weight (lbs)
Catalog Number	List Price	Catalog Number	List Price		
<b>Tables w/Metal Legs, Juvenile</b>					
77M-J09-S00	\$ 1,975.00	77M-J09-S02	\$ 1,853.00	36" Diameter, 25"H	
77M-J29-S00	\$ 2,086.00	77M-J29-S02	\$ 1,963.00	42" Diameter, 25"H	
77M-J41-S00	\$ 2,086.00	77M-J41-S02	\$ 1,963.00	48" Diameter, 25"H	
N/A	\$ -	77M-J30-S02	\$ 2,356.00	60" Diameter, 25"H	
77M-J91-S00	\$ 1,596.00	77M-J91-S02	\$ 1,438.00	30" Square Table, 25"H	
77M-J37-S00	\$ 1,707.00	77M-J37-S02	\$ 1,548.00	42" Square Table, 25"H	
77M-J54-S00	\$ 1,829.00	77M-J54-S02	\$ 1,671.00	48" Square Table, 25"H	
77M-J94-S00	\$ 1,871.00	77M-J94-S02	\$ 1,676.00	30" X 60" Table, 25"H	
77M-J95-S00	\$ 1,972.00	77M-J95-S02	\$ 1,805.00	30" X 72" Table, 25"H	
77M-J98-S00	\$ 2,501.00	77M-J98-S02	\$ 2,480.00	30" X 90" Table, 25"H	
77M-J44-S00	\$ 1,920.00	77M-J44-S02	\$ 1,750.00	36" X 60" Table, 25"H	
77M-J38-S00	\$ 2,045.00	77M-J38-S02	\$ 1,879.00	36" X 72" Table, 25"H	
77M-J46-S00	\$ 2,751.00	77M-J46-S02	\$ 2,553.00	36" X 90" Table, 25"H	
77M-J45-S00	\$ 2,614.00	77M-J45-S02	\$ 2,190.00	48" X 72" Table, 25"H	
77M-J34-S00	\$ 2,995.00	77M-J34-S02	\$ 2,811.00	48" X 90" Table, 25"H	



Please specify Wood Finish, Plastic Laminate, and Metal Color. Details can be found in the Product Options section at the front of this Price List.

# Libris Collection (prices shown in Oak wood)

## Tables, Adult Height, Wood Legs

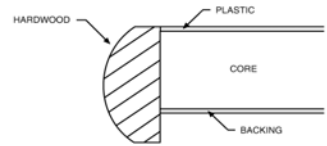
### 2009 Brodart Furniture - List Prices



Plywood Core		Particleboard Core		Description	Weight (lbs)
Catalog Number	List Price	Catalog Number	List Price		
<b>Tables w/Wood Legs, Adult</b>					
4W-109-S02	\$ 1,469.00	4W-109-S00	\$ 1,238.00	36" Diameter, 29"H	
4W-129-S02	\$ 1,574.00	4W-129-S00	\$ 1,342.00	42" Diameter, 29"H	
4W-141-S02	\$ 1,574.00	4W-141-S00	\$ 1,342.00	48" Diameter, 29"H	
N/A	\$ -	4W-130-S00	\$ 1,856.00	60" Diameter, 29"H	
4W-191-S02	\$ 1,226.00	4W-191-S00	\$ 1,046.00	30" Square Table, 29"H	
4W-137-S02	\$ 1,331.00	4W-137-S00	\$ 1,150.00	42" Square Table, 29"H	
4W-154-S02	\$ 1,530.00	4W-154-S00	\$ 1,304.00	48" Square Table, 29"H	
4W-194-S02	\$ 1,325.00	4W-194-S00	\$ 1,147.00	30" X 60" Table, 29"H	
4W-195-S02	\$ 1,377.00	4W-195-S00	\$ 1,172.00	30" X 72" Table, 29"H	
4W-198-S02	\$ 2,108.00	4W-198-S00	\$ 1,826.00	30" X 90" Table, 29"H	
4W-144-S02	\$ 1,394.00	4W-144-S00	\$ 1,216.00	36" X 60" Table, 29"H	
4W-138-S02	\$ 1,446.00	4W-138-S00	\$ 1,241.00	36" X 72" Table, 29"H	
4W-146-S02	\$ 2,177.00	4W-146-S00	\$ 1,895.00	36" X 90" Table, 29"H	
4W-145-S02	\$ 1,562.00	4W-145-S00	\$ 1,356.00	48" X 72" Table, 29"H	
4W-134-S02	\$ 2,233.00	4W-134-S00	\$ 2,033.00	48" X 90" Table, 29"H	

**Please specify Wood Finish, and Plastic Laminate. Details can be found in the Product Options section at the front of this Price List.**

#### Optional Metal Accent Strips for Tables

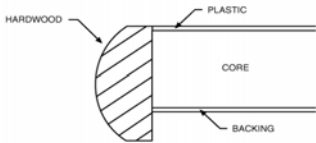

M09-AK-S00	\$ -	36" Diameter Table	5
M29-AK-S00	\$ -	42" Diameter Table	5
M41-AK-S00	\$ -	48" Diameter Table	5
M30-AK-S00	\$ -	60" Diameter Table	8
M91-AK-S00	\$ -	30" Square Table	5
M37-AK-S00	\$ -	42" Square Table	5
M54-AK-S00	\$ -	48" Square Table	5
M69-AK-S00	\$ -	30" X 60" Table	5
M95-AK-S00	\$ -	30" X 72" Table	5
M98-AK-S00	\$ -	30" X 90" Table	5
M44-AK-S00	\$ -	36" X 60" Table	8
M38-AK-S00	\$ -	36" X 72" Table	8
M46-AK-S00	\$ -	36" X 90" Table	10
M45-AK-S00	\$ -	48" X 72" Table	10
M34-AK-S00	\$ -	48" X 90" Table	12

**Note:** Metal Accent Strips must be ordered separately: however there is no additional charge for these strips. Metal paint color for accent strips must be specified with the order. Oak corner pieces will be painted black unless specified otherwise.



# Libris Collection (prices shown in Oak wood)

## Tables, Adult Height, Metal Legs 2009 Brodart Furniture - List Prices

Plywood Core		Particleboard Core		Description	Weight (lbs)
Catalog Number	List Price	Catalog Number	List Price		
<b>Tables w/Metal Legs, Adult</b>					
4M-109-S02	\$ 1,666.00	4M-109-S00	\$ 1,435.00	36" Diameter, 29"H	
4M-129-S02	\$ 1,770.00	4M-129-S00	\$ 1,539.00	42" Diameter, 29"H	
4M-141-S02	\$ 1,770.00	4M-141-S00	\$ 1,539.00	48" Diameter, 29"H	
N/A	\$ -	4M-130-S00	\$ 2,083.00	60" Diameter, 29"H	
4M-191-S02	\$ 1,388.00	4M-191-S00	\$ 1,180.00	30" Square Table, 29"H	
4M-137-S02	\$ 1,493.00	4M-137-S00	\$ 1,284.00	42" Square Table, 29"H	
4M-154-S02	\$ 1,717.00	4M-154-S00	\$ 1,494.00	48" Square Table, 29"H	
4M-194-S02	\$ 1,513.00	4M-194-S00	\$ 1,311.00	30" X 60" Table, 29"H	
4M-195-S02	\$ 1,547.00	4M-195-S00	\$ 1,332.00	30" X 72" Table, 29"H	
4M-198-S02	\$ 2,108.00	4M-198-S00	\$ 2,009.00	30" X 90" Table, 29"H	
4M-144-S02	\$ 1,583.00	4M-144-S00	\$ 1,380.00	36" X 60" Table, 29"H	
4M-138-S02	\$ 1,616.00	4M-138-S00	\$ 1,401.00	36" X 72" Table, 29"H	
4M-146-S02	\$ 2,389.00	4M-146-S00	\$ 2,078.00	36" X 90" Table, 29"H	
4M-145-S02	\$ 1,748.00	4M-145-S00	\$ 1,518.00	48" X 72" Table, 29"H	
4M-134-S02	\$ 2,422.00	4M-134-S00	\$ 2,190.00	48" X 90" Table, 29"H	

**Please specify Wood Finish, Plastic Laminate, and Metal Color. Details can be found in the Product Options section at the front of this Price List.**

### Optional Metal Accent Strips for Tables



M09-AK-S00	\$ -	36" Diameter Table	5
M29-AK-S00	\$ -	42" Diameter Table	5
M41-AK-S00	\$ -	48" Diameter Table	5
M30-AK-S00	\$ -	60" Diameter Table	8
M91-AK-S00	\$ -	30" Square Table	5
M37-AK-S00	\$ -	42" Square Table	5
M54-AK-S00	\$ -	48" Square Table	5
M69-AK-S00	\$ -	30" X 60" Table	5
M95-AK-S00	\$ -	30" X 72" Table	5
M98-AK-S00	\$ -	30" X 90" Table	5
M44-AK-S00	\$ -	36" X 60" Table	8
M38-AK-S00	\$ -	36" X 72" Table	8
M46-AK-S00	\$ -	36" X 90" Table	10
M45-AK-S00	\$ -	48" X 72" Table	10
M34-AK-S00	\$ -	48" X 90" Table	12

**Note:** Metal Accent Strips must be ordered separately: however there is no additional charge for these strips. Metal paint color for accent strips must be specified with the order. Oak corner pieces will be painted black unless specified otherwise.

**Libris Collection (prices shown in Oak wood)**

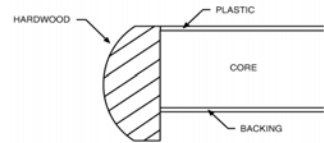
**Tables, Youth Height, Wood Legs  
2009 Brodart Furniture - List Prices**



Plywood Core		Particleboard Core		Description	Weight (lbs)
Catalog Number	List Price	Catalog Number	List Price		
<b>Tables w/Wood Legs, Youth</b>					
4W-Y09-S02	\$ 1,469.00	4W-Y09-S00	\$ 1,238.00	36" Diameter, 27 1/2"H	
4W-Y29-S02	\$ 1,574.00	4W-Y29-S00	\$ 1,342.00	42" Diameter, 27 1/2"H	
4W-Y41-S02	\$ 1,574.00	4W-Y41-S00	\$ 1,342.00	48" Diameter, 27 1/2"H	
N/A	\$ -	4W-Y30-S00	\$ 1,856.00	60" Diameter, 27 1/2"H	
4W-Y91-S02	\$ 1,226.00	4W-Y91-S00	\$ 1,046.00	30" Square Table, 27 1/2"H	
4W-Y37-S02	\$ 1,331.00	4W-Y37-S00	\$ 1,150.00	42" Square Table, 27 1/2"H	
4W-Y54-S02	\$ 1,530.00	4W-Y54-S00	\$ 1,304.00	48" Square Table, 27 1/2"H	
4W-Y94-S02	\$ 1,325.00	4W-Y94-S00	\$ 1,147.00	30" X 60" Table, 27 1/2"H	
4W-Y95-S02	\$ 1,377.00	4W-Y95-S00	\$ 1,172.00	30" X 72" Table, 27 1/2"H	
4W-Y98-S02	\$ 2,108.00	4W-Y98-S00	\$ 1,826.00	30" X 90" Table, 27 1/2"H	
4W-Y44-S02	\$ 1,394.00	4W-Y44-S00	\$ 1,216.00	36" X 60" Table, 27 1/2"H	
4W-Y38-S02	\$ 1,446.00	4W-Y38-S00	\$ 1,241.00	36" X 72" Table, 27 1/2"H	
4W-Y46-S02	\$ 2,177.00	4W-Y46-S00	\$ 1,895.00	36" X 90" Table, 27 1/2"H	
4W-Y45-S02	\$ 1,562.00	4W-Y45-S00	\$ 1,356.00	48" X 72" Table, 27 1/2"H	
4W-Y34-S02	\$ 2,233.00	4W-Y34-S00	\$ 2,033.00	48" X 90" Table, 27 1/2"H	

**Please specify Wood Finish, and Plastic Laminate. Details can be found in the Product Options section at the front of this Price List.**

**Optional Metal Accent Strips for Tables**

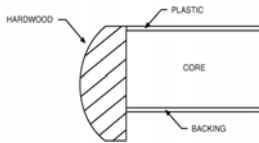

M09-AK-S00	\$ -	36" Diameter Table	5
M29-AK-S00	\$ -	42" Diameter Table	5
M41-AK-S00	\$ -	48" Diameter Table	5
M30-AK-S00	\$ -	60" Diameter Table	8
M91-AK-S00	\$ -	30" Square Table	5
M37-AK-S00	\$ -	42" Square Table	5
M54-AK-S00	\$ -	48" Square Table	5
M69-AK-S00	\$ -	30" X 60" Table	5
M95-AK-S00	\$ -	30" X 72" Table	5
M98-AK-S00	\$ -	30" X 90" Table	5
M44-AK-S00	\$ -	36" X 60" Table	8
M38-AK-S00	\$ -	36" X 72" Table	8
M46-AK-S00	\$ -	36" X 90" Table	10
M45-AK-S00	\$ -	48" X 72" Table	10
M34-AK-S00	\$ -	48" X 90" Table	12

**Note:** Metal Accent Strips must be ordered separately: however there is no additional charge for these strips. Metal paint color for accent strips must be specified with the order. Oak corner pieces will be painted black unless specified otherwise.



# Libris Collection (prices shown in Oak wood)

## Tables, Youth Height, Metal Legs 2009 Brodart Furniture - List Prices

Plywood Core		Particleboard Core		Description	Weight (lbs)
Catalog Number	List Price	Catalog Number	List Price		
<b>Tables w/Metal Legs, Youth</b>					
4M-Y09-S02	\$ 1,666.00	4M-Y09-S00	\$ 1,435.00	36" Diameter, 27 1/2"H	
4M-Y29-S02	\$ 1,770.00	4M-Y29-S00	\$ 1,539.00	42" Diameter, 27 1/2"H	
4M-Y41-S02	\$ 1,770.00	4M-Y41-S00	\$ 1,539.00	48" Diameter, 27 1/2"H	
N/A	\$ -	4M-Y30-S00	\$ 2,083.00	60" Diameter, 27 1/2"H	
4M-Y91-S02	\$ 1,388.00	4M-Y91-S00	\$ 1,180.00	30" Square Table, 27 1/2"H	
4M-Y37-S02	\$ 1,493.00	4M-Y37-S00	\$ 1,284.00	42" Square Table, 27 1/2"H	
4M-Y54-S02	\$ 1,717.00	4M-Y54-S00	\$ 1,494.00	48" Square Table, 27 1/2"H	
4M-Y94-S02	\$ 1,513.00	4M-Y94-S00	\$ 1,311.00	30" X 60" Table, 27 1/2"H	
4M-Y95-S02	\$ 1,547.00	4M-Y95-S00	\$ 1,332.00	30" X 72" Table, 27 1/2"H	
4M-Y98-S02	\$ 2,108.00	4M-Y98-S00	\$ 2,009.00	30" X 90" Table, 27 1/2"H	
4M-Y44-S02	\$ 1,583.00	4M-Y44-S00	\$ 1,380.00	36" X 60" Table, 27 1/2"H	
4M-Y38-S02	\$ 1,616.00	4M-Y38-S00	\$ 1,401.00	36" X 72" Table, 27 1/2"H	
4M-Y46-S02	\$ 2,389.00	4M-Y46-S00	\$ 2,078.00	36" X 90" Table, 27 1/2"H	
4M-Y45-S02	\$ 1,748.00	4M-Y45-S00	\$ 1,518.00	48" X 72" Table, 27 1/2"H	
4M-Y34-S02	\$ 2,422.00	4M-Y34-S00	\$ 2,190.00	48" X 90" Table, 27 1/2"H	

**Please specify Wood Finish, Plastic Laminate, and Metal Color. Details can be found in the Product Options section at the front of this Price List.**

### Optional Metal Accent Strips for Tables

M09-AK-S00	\$ -	36" Diameter Table	5
M29-AK-S00	\$ -	42" Diameter Table	5
M41-AK-S00	\$ -	48" Diameter Table	5
M30-AK-S00	\$ -	60" Diameter Table	8
M91-AK-S00	\$ -	30" Square Table	5
M37-AK-S00	\$ -	42" Square Table	5
M54-AK-S00	\$ -	48" Square Table	5
M69-AK-S00	\$ -	30" X 60" Table	5
M95-AK-S00	\$ -	30" X 72" Table	5
M98-AK-S00	\$ -	30" X 90" Table	5
M44-AK-S00	\$ -	36" X 60" Table	8
M38-AK-S00	\$ -	36" X 72" Table	8
M46-AK-S00	\$ -	36" X 90" Table	10
M45-AK-S00	\$ -	48" X 72" Table	10
M34-AK-S00	\$ -	48" X 90" Table	12



**Note:** Metal Accent Strips must be ordered separately; however there is no additional charge for these strips. Metal paint color for accent strips must be specified with the order. Oak corner pieces will be painted black unless specified otherwise.

# Libris Collection (prices shown in Oak wood)

## Tables, Juvenile Height, Wood Legs

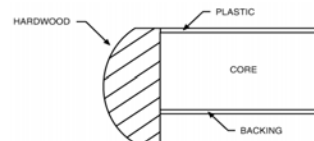
### 2009 Brodart Furniture - List Prices



Plywood Core		Particleboard Core		Description	Weight (lbs)	
Catalog Number	List Price	Catalog Number	List Price			
<b>Tables w/Wood Legs, Juvenile</b>						
4W-J09-S02	\$ 1,469.00	4W-J09-S00	\$ 1,238.00	36" Diameter, 25"H		100
4W-J29-S02	\$ 1,574.00	4W-J29-S00	\$ 1,342.00	42" Diameter, 25"H		110
4W-J41-S02	\$ 1,574.00	4W-J41-S00	\$ 1,342.00	48" Diameter, 25"H		120
N/A	\$ -	4W-J30-S00	\$ 1,856.00	60" Diameter, 25"H		140
4W-J91-S02	\$ 1,226.00	4W-J91-S00	\$ 1,046.00	30" Square Table, 25"H		110
4W-J37-S02	\$ 1,331.00	4W-J37-S00	\$ 1,150.00	42" Square Table, 25"H		110
4W-J54-S02	\$ 1,530.00	4W-J54-S00	\$ 1,304.00	48" Square Table, 25"H		120
4W-J94-S02	\$ 1,325.00	4W-J94-S00	\$ 1,147.00	30" X 60" Table, 25"H		120
4W-J95-S02	\$ 1,377.00	4W-J95-S00	\$ 1,172.00	30" X 72" Table, 25"H		140
4W-J98-S02	\$ 2,108.00	4W-J98-S00	\$ 1,826.00	30" X 90" Table, 25"H		160
4W-J44-S02	\$ 1,394.00	4W-J44-S00	\$ 1,216.00	36" X 60" Table, 25"H		120
4W-J38-S02	\$ 1,446.00	4W-J38-S00	\$ 1,241.00	36" X 72" Table, 25"H		140
4W-J46-S02	\$ 2,177.00	4W-J46-S00	\$ 1,895.00	36" X 90" Table, 25"H		160
4W-J45-S02	\$ 1,562.00	4W-J45-S00	\$ 1,356.00	48" X 72" Table, 25"H		170
4W-J34-S02	\$ 2,233.00	4W-J34-S00	\$ 2,033.00	48" X 90" Table, 25"H	185	

**Please specify Wood Finish, and Plastic Laminate. Details can be found in the Product Options section at the front of this Price List.**

#### Optional Metal Accent Strips for Tables

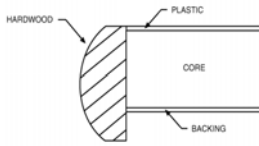

M09-AK-S00	\$ -	36" Diameter Table	5
M29-AK-S00	\$ -	42" Diameter Table	5
M41-AK-S00	\$ -	48" Diameter Table	5
M30-AK-S00	\$ -	60" Diameter Table	8
M91-AK-S00	\$ -	30" Square Table	5
M37-AK-S00	\$ -	42" Square Table	5
M54-AK-S00	\$ -	48" Square Table	5
M69-AK-S00	\$ -	30" X 60" Table	5
M95-AK-S00	\$ -	30" X 72" Table	5
M98-AK-S00	\$ -	30" X 90" Table	5
M44-AK-S00	\$ -	36" X 60" Table	8
M38-AK-S00	\$ -	36" X 72" Table	8
M46-AK-S00	\$ -	36" X 90" Table	10
M45-AK-S00	\$ -	48" X 72" Table	10
M34-AK-S00	\$ -	48" X 90" Table	12

**Note:** Metal Accent Strips must be ordered separately: however there is no additional charge for these strips. Metal paint color for accent strips must be specified with the order. Oak corner pieces will be painted black unless specified otherwise.



**Libris Collection (prices shown in Oak wood)**

**Tables, Juvenile Height, Metal Legs  
2009 Brodart Furniture - List Prices**

Plywood Core		Particleboard Core		Description	Weight (lbs)
Catalog Number	List Price	Catalog Number	List Price		
<b>Tables w/Metal Legs, Juvenile</b>					
4M-J09-S02	\$ 1,666.00	4M-J09-S00	\$ 1,435.00	36" Diameter, 25"H	
4M-J29-S02	\$ 1,770.00	4M-J29-S00	\$ 1,539.00	42" Diameter, 25"H	
4M-J41-S02	\$ 1,770.00	4M-J41-S00	\$ 1,539.00	48" Diameter, 25"H	
N/A	\$ -	4M-J30-S00	\$ 2,083.00	60" Diameter, 25"H	
4M-J91-S02	\$ 1,388.00	4M-J91-S00	\$ 1,180.00	30" Square Table, 25"H	
4M-J37-S02	\$ 1,493.00	4M-J37-S00	\$ 1,284.00	42" Square Table, 25"H	
4M-J54-S02	\$ 1,717.00	4M-J54-S00	\$ 1,494.00	48" Square Table, 25"H	
4M-J94-S02	\$ 1,513.00	4M-J94-S00	\$ 1,311.00	30" X 60" Table, 25"H	
4M-J95-S02	\$ 1,547.00	4M-J95-S00	\$ 1,332.00	30" X 72" Table, 25"H	
4M-J98-S02	\$ 2,108.00	4M-J98-S00	\$ 2,009.00	30" X 90" Table, 25"H	
4M-J44-S02	\$ 1,583.00	4M-J44-S00	\$ 1,380.00	36" X 60" Table, 25"H	
4M-J38-S02	\$ 1,616.00	4M-J38-S00	\$ 1,401.00	36" X 72" Table, 25"H	
4M-J46-S02	\$ 2,389.00	4M-J46-S00	\$ 2,078.00	36" X 90" Table, 25"H	
4M-J45-S02	\$ 1,748.00	4M-J45-S00	\$ 1,518.00	48" X 72" Table, 25"H	
4M-J34-S02	\$ 2,422.00	4M-J34-S00	\$ 2,190.00	48" X 90" Table, 25"H	

**Please specify Wood Finish, Plastic Laminate, and Metal Color. Details can be found in the Product Options section at the front of this Price List.**

**Optional Metal Accent Strips for Tables**

M09-AK-S00	\$ -	36" Diameter Table	5
M29-AK-S00	\$ -	42" Diameter Table	5
M41-AK-S00	\$ -	48" Diameter Table	5
M30-AK-S00	\$ -	60" Diameter Table	8
M91-AK-S00	\$ -	30" Square Table	5
M37-AK-S00	\$ -	42" Square Table	5
M54-AK-S00	\$ -	48" Square Table	5
M69-AK-S00	\$ -	30" X 60" Table	5
M95-AK-S00	\$ -	30" X 72" Table	5
M98-AK-S00	\$ -	30" X 90" Table	5
M44-AK-S00	\$ -	36" X 60" Table	8
M38-AK-S00	\$ -	36" X 72" Table	8
M46-AK-S00	\$ -	36" X 90" Table	10
M45-AK-S00	\$ -	48" X 72" Table	10
M34-AK-S00	\$ -	48" X 90" Table	12

**Note:** Metal Accent Strips must be ordered separately: however there is no additional charge for these strips. Metal paint color for accent strips must be specified with the order. Oak corner pieces will be painted black unless specified otherwise.

# Matrix Collection (prices shown in Maple wood)

## Tables, Adult Height, Wood Legs

### 2009 Brodart Furniture - List Prices

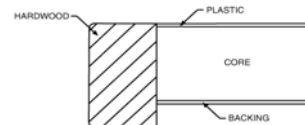



Plywood Core		Particleboard Core		Description	Weight (lbs)
Catalog Number	List Price	Catalog Number	List Price		
<b>Tables w/ Wood Legs, Adult Height</b>					
93-109-S00	\$ 1,793.00	93-109-S02	\$ 1,739.00	36" Diameter, 29"H	
93-129-S00	\$ 1,903.00	93-129-S02	\$ 1,750.00	42" Diameter, 29"H	
93-141-S00	\$ 1,903.00	93-141-S02	\$ 1,750.00	48" Diameter, 29"H	
N/A	\$ -	93-130-S02	\$ 2,468.00	60" Diameter, 29"H	
93-191-S00	\$ 1,572.00	93-191-S02	\$ 1,469.00	30" Square Table, 29"H	
93-137-S00	\$ 1,682.00	93-137-S02	\$ 1,579.00	42" Square Table, 29"H	
93-154-S00	\$ 1,805.00	93-154-S02	\$ 1,702.00	48" Square Table, 29"H	
93-194-S00	\$ 1,713.00	93-194-S02	\$ 1,551.00	30" X 60" Table, 29"H	
93-195-S00	\$ 1,953.00	93-195-S02	\$ 1,744.00	30" X 72" Table, 29"H	
93-198-S00	\$ 2,499.00	93-198-S02	\$ 2,167.00	30" X 90" Table, 29"H	
93-144-S00	\$ 1,787.00	93-144-S02	\$ 1,625.00	36" X 60" Table, 29"H	
93-138-S00	\$ 2,026.00	93-138-S02	\$ 1,817.00	36" X 72" Table, 29"H	
93-146-S00	\$ 2,573.00	93-146-S02	\$ 2,241.00	36" X 90" Table, 29"H	
93-145-S00	\$ 2,149.00	93-145-S02	\$ 1,977.00	48" X 72" Table, 29"H	
93-134-S00	\$ 2,763.00	93-134-S02	\$ 2,395.00	48" X 90" Table, 29"H	

Please specify Wood Finish, and Plastic Laminate. Details can be found in the Product Options section at the front of this Price List.

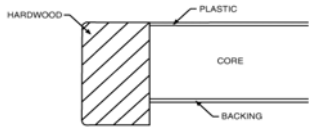

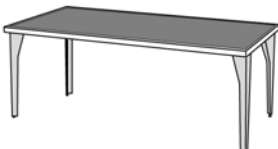
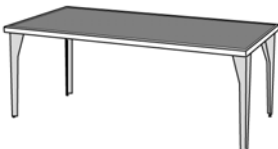
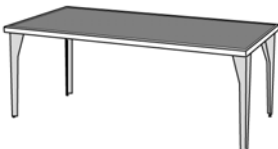

**Matrix Collection (prices shown in Maple wood)  
Tables, Adult Height, Metal Legs  
2009 Brodart Furniture - List Prices**

Plywood Core		Particleboard Core		Description	Weight (lbs)
Catalog Number	List Price	Catalog Number	List Price		
<b>Tables w/ Metal Legs, Adult Height</b>					
93M-109-S00	\$ 1,885.00	93M-109-S02	\$ 1,701.00	36" Diameter, 29"H	
93M-129-S00	\$ 1,996.00	93M-129-S02	\$ 1,811.00	42" Diameter, 29"H	
93M-141-S00	\$ 1,996.00	93M-141-S02	\$ 1,811.00	48" Diameter, 29"H	
N/A	\$ -	93M-130-S02	\$ 2,524.00	60" Diameter, 29"H	
93M-191-S00	\$ 1,637.00	93M-191-S02	\$ 1,517.00	30" Square Table, 29"H	
93M-137-S00	\$ 1,747.00	93M-137-S02	\$ 1,627.00	42" Square Table, 29"H	
93M-154-S00	\$ 1,870.00	93M-154-S02	\$ 1,750.00	48" Square Table, 29"H	
93M-194-S00	\$ 1,756.00	93M-194-S02	\$ 1,605.00	30" X 60" Table, 29"H	
93M-195-S00	\$ 2,069.00	93M-195-S02	\$ 1,744.00	30" X 72" Table, 29"H	
93M-198-S00	\$ 2,499.00	93M-198-S02	\$ 2,167.00	30" X 90" Table, 29"H	
93M-144-S00	\$ 1,830.00	93M-144-S02	\$ 1,679.00	36" X 60" Table, 29"H	
93M-138-S00	\$ 2,143.00	93M-138-S02	\$ 1,934.00	36" X 72" Table, 29"H	
93M-146-S00	\$ 2,640.00	93M-146-S02	\$ 2,364.00	36" X 90" Table, 29"H	
93M-145-S00	\$ 2,407.00	93M-145-S02	\$ 2,081.00	48" X 72" Table, 29"H	
93M-134-S00	\$ 2,941.00	93M-134-S02	\$ 2,622.00	48" X 90" Table, 29"H	

**Please specify Wood Finish, Plastic Laminate, and Metal Color. Details can be found in the Product Options section at the front of this Price List.**

# Matrix Collection (prices shown in Maple wood)

## Tables, Youth Height, Wood Legs

### 2009 Brodart Furniture - List Prices

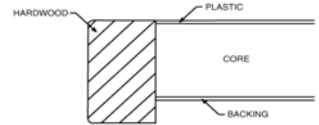

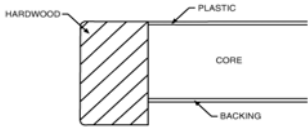

Plywood Core		Particleboard Core		Description	Weight (lbs)
Catalog Number	List Price	Catalog Number	List Price		
<b>Tables w/ Wood Legs, Youth Height</b>					
93-Y09-S00	\$ 1,793.00	93-Y09-S02	\$ 1,739.00	36" Diameter, 27 1/2"H	
93-Y29-S00	\$ 1,903.00	93-Y29-S02	\$ 1,750.00	42" Diameter, 27 1/2"H	
93-Y41-S00	\$ 1,903.00	93-Y41-S02	\$ 1,750.00	48" Diameter, 27 1/2"H	
N/A	\$ -	93-Y30-S02	\$ 2,468.00	60" Diameter, 27 1/2"H	
93-Y91-S00	\$ 1,572.00	93-Y91-S02	\$ 1,469.00	30" Square Table, 27 1/2"H	
93-Y37-S00	\$ 1,682.00	93-Y37-S02	\$ 1,579.00	42" Square Table, 27 1/2"H	
93-Y54-S00	\$ 1,805.00	93-Y54-S02	\$ 1,702.00	48" Square Table, 27 1/2"H	
93-Y94-S00	\$ 1,713.00	93-Y94-S02	\$ 1,551.00	30" X 60" Table, 27 1/2"H	
93-Y95-S00	\$ 1,953.00	93-Y95-S02	\$ 1,744.00	30" X 72" Table, 27 1/2"H	
93-Y98-S00	\$ 2,499.00	93-Y98-S02	\$ 2,167.00	30" X 90" Table, 27 1/2"H	
93-Y44-S00	\$ 1,787.00	93-Y44-S02	\$ 1,625.00	36" X 60" Table, 27 1/2"H	
93-Y38-S00	\$ 2,026.00	93-Y38-S02	\$ 1,817.00	36" X 72" Table, 27 1/2"H	
93-Y46-S00	\$ 2,573.00	93-Y46-S02	\$ 2,241.00	36" X 90" Table, 27 1/2"H	
93-Y45-S00	\$ 2,149.00	93-Y45-S02	\$ 1,977.00	48" X 72" Table, 27 1/2"H	
93-Y34-S00	\$ 2,763.00	93-Y34-S02	\$ 2,395.00	48" X 90" Table, 27 1/2"H	

Please specify Wood Finish, and Plastic Laminate. Details can be found in the Product Options section at the front of this Price List.

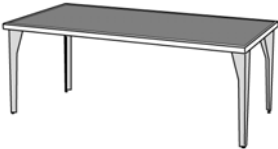
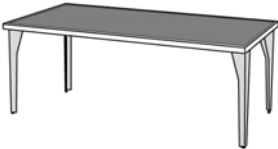
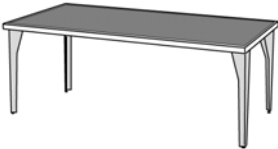

**Matrix Collection (prices shown in Maple wood)  
Tables, Youth Height, Metal Legs  
2009 Brodart Furniture - List Prices**

Plywood Core		Particleboard Core		Description	Weight (lbs)
Catalog Number	List Price	Catalog Number	List Price		
<b>Tables w/ Metal Legs, Youth Height</b>					
93M-Y09-S00	\$ 1,885.00	93M-Y09-S02	\$ 1,701.00	36" Diameter, 27 1/2"H	
93M-Y29-S00	\$ 1,996.00	93M-Y29-S02	\$ 1,811.00	42" Diameter, 27 1/2"H	
93M-Y41-S00	\$ 1,996.00	93M-Y41-S02	\$ 1,811.00	48" Diameter, 27 1/2"H	
N/A	\$ -	93M-130-S02	\$ 2,524.00	60" Diameter, 27 1/2"H	
93M-Y91-S00	\$ 1,637.00	93M-Y91-S02	\$ 1,517.00	30" Square Table, 27 1/2"H	
93M-Y37-S00	\$ 1,747.00	93M-Y37-S02	\$ 1,627.00	42" Square Table, 27 1/2"H	
93M-Y54-S00	\$ 1,870.00	93M-Y54-S02	\$ 1,750.00	48" Square Table, 27 1/2"H	
93M-Y94-S00	\$ 1,756.00	93M-Y94-S02	\$ 1,605.00	30" X 60" Table, 27 1/2"H	
93M-Y95-S00	\$ 2,069.00	93M-Y95-S02	\$ 1,744.00	30" X 72" Table, 27 1/2"H	
93M-Y98-S00	\$ 2,499.00	93M-Y98-S02	\$ 2,167.00	30" X 90" Table, 27 1/2"H	
93M-Y44-S00	\$ 1,830.00	93M-Y44-S02	\$ 1,679.00	36" X 60" Table, 27 1/2"H	
93M-Y38-S00	\$ 2,143.00	93M-Y38-S02	\$ 1,934.00	36" X 72" Table, 27 1/2"H	
93M-Y46-S00	\$ 2,640.00	93M-Y46-S02	\$ 2,364.00	36" X 90" Table, 27 1/2"H	
93M-Y45-S00	\$ 2,407.00	93M-Y45-S02	\$ 2,081.00	48" X 72" Table, 27 1/2"H	
93M-Y34-S00	\$ 2,941.00	93M-Y34-S02	\$ 2,622.00	48" X 90" Table, 27 1/2"H	

**Please specify Wood Finish, Plastic Laminate, and Metal Color. Details can be found in the Product Options section at the front of this Price List.**

# Matrix Collection (prices shown in Maple wood)

## Tables, Juvenile Height, Wood Legs

### 2009 Brodart Furniture - List Prices

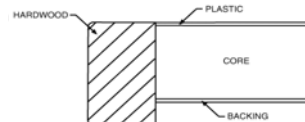



Plywood Core		Particleboard Core		Description	Weight (lbs)
Catalog Number	List Price	Catalog Number	List Price		

#### Tables w/ Wood Legs, Juvenile Height

93-J09-S00	\$ 1,793.00	93-J09-S02	\$ 1,739.00	36" Diameter, 25"H		100
93-J29-S00	\$ 1,903.00	93-J29-S02	\$ 1,750.00	42" Diameter, 25"H		110
93-J41-S00	\$ 1,903.00	93-J41-S02	\$ 1,750.00	48" Diameter, 25"H		120
N/A	\$ -	93-J30-S02	\$ 2,468.00	60" Diameter, 25"H		140

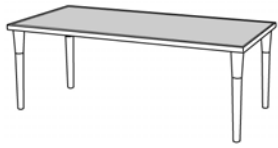
93-J91-S00	\$ 1,572.00	93-J91-S02	\$ 1,469.00	30" Square Table, 25"H		110
93-J37-S00	\$ 1,682.00	93-J37-S02	\$ 1,579.00	42" Square Table, 25"H		110
93-J54-S00	\$ 1,805.00	93-J54-S02	\$ 1,702.00	48" Square Table, 25"H		110

93-J94-S00	\$ 1,713.00	93-J94-S02	\$ 1,551.00	30" X 60" Table, 25"H		120
93-J95-S00	\$ 1,953.00	93-J95-S02	\$ 1,744.00	30" X 72" Table, 25"H		140
93-J98-S00	\$ 2,499.00	93-J98-S02	\$ 2,167.00	30" X 90" Table, 25"H		160

93-J44-S00	\$ 1,787.00	93-J44-S02	\$ 1,625.00	36" X 60" Table, 25"H		120
93-J38-S00	\$ 2,026.00	93-J38-S02	\$ 1,817.00	36" X 72" Table, 25"H		140
93-J46-S00	\$ 2,573.00	93-J46-S02	\$ 2,241.00	36" X 90" Table, 25"H		160

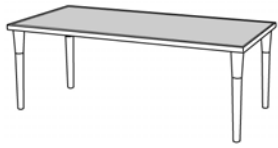
93-J45-S00	\$ 2,149.00	93-J45-S02	\$ 1,977.00	48" X 72" Table, 25"H		170
93-J34-S00	\$ 2,763.00	93-J34-S02	\$ 2,395.00	48" X 90" Table, 25"H		185

Please specify Wood Finish, and Plastic Laminate. Details can be found in the Product Options section at the front of this Price List.

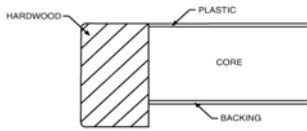

**Matrix Collection (prices shown in Maple wood)**  
**Tables, Juvenile Height, Metal Legs**  
**2009 Brodart Furniture - List Prices**

Plywood Core		Particleboard Core		Description	Weight (lbs)
Catalog Number	List Price	Catalog Number	List Price		
<b>Tables w/ Metal Legs, Juvenile Height</b>					
93M-J09-S00	\$ 1,885.00	93M-J09-S02	\$ 1,701.00	36" Diameter, 25"H	
93M-J29-S00	\$ 1,996.00	93M-J29-S02	\$ 1,811.00	42" Diameter, 25"H	
93M-J41-S00	\$ 1,996.00	93M-J41-S02	\$ 1,811.00	48" Diameter, 25"H	
N/A	\$ -	93M-130-S02	\$ 2,524.00	60" Diameter, 25"H	
93M-J91-S00	\$ 1,637.00	93M-J91-S02	\$ 1,517.00	30" Square Table, 25"H	
93M-J37-S00	\$ 1,747.00	93M-J37-S02	\$ 1,627.00	42" Square Table, 25"H	
93M-J54-S00	\$ 1,870.00	93M-J54-S02	\$ 1,750.00	48" Square Table, 25"H	
93M-J94-S00	\$ 1,756.00	93M-J94-S02	\$ 1,605.00	30" X 60" Table, 25"H	
93M-J95-S00	\$ 2,069.00	93M-J95-S02	\$ 1,744.00	30" X 72" Table, 25"H	
93M-J98-S00	\$ 2,499.00	93M-J98-S02	\$ 2,167.00	30" X 90" Table, 25"H	
93M-J44-S00	\$ 1,830.00	93M-J44-S02	\$ 1,679.00	36" X 60" Table, 25"H	
93M-J38-S00	\$ 2,143.00	93M-J38-S02	\$ 1,934.00	36" X 72" Table, 25"H	
93M-J46-S00	\$ 2,640.00	93M-J46-S02	\$ 2,364.00	36" X 90" Table, 25"H	
93M-J45-S00	\$ 2,407.00	93M-J45-S02	\$ 2,081.00	48" X 72" Table, 25"H	
93M-J34-S00	\$ 2,941.00	93M-J34-S02	\$ 2,622.00	48" X 90" Table, 25"H	

**Please specify Wood Finish, Plastic Laminate, and Metal Color. Details can be found in the Product Options section at the front of this Price List.**

# M-Table (prices shown in Oak wood)

## Tables, Adult Height

### 2009 Brodart Furniture - List Prices

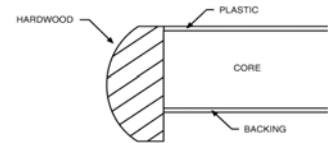

Plywood Core		Particleboard Core		Description	Weight (lbs)
Catalog Number	List Price	Catalog Number	List Price		
<b>Tables w/ Metal Legs, Adult Height</b>					
MT-109-S00	\$ 1,567.00	MT-109-S00	\$ 1,376.00	36" Diameter, 29"H	100
MT-129-S00	\$ 1,678.00	MT-129-S02	\$ 1,487.00	42" Diameter, 29"H	90
MT-141-S00	\$ 1,678.00	MT-141-S02	\$ 1,487.00	48" Diameter, 29"H	100
MT-191-S00	\$ 1,383.00	MT-191-S02	\$ 1,180.00	30" Square Table, 29"H	100
MT-137-S00	\$ 1,493.00	MT-137-S02	\$ 1,290.00	42" Square Table, 29"H	100
MT-154-S00	\$ 1,616.00	MT-154-S02	\$ 1,413.00	48" Square Table, 29"H	100
MT-194-S00	\$ 1,397.00	MT-194-S02	\$ 1,211.00	30" X 60" Table, 29"H	110
MT-195-S00	\$ 1,549.00	MT-195-S02	\$ 1,346.00	30" X 72" Table, 29"H	130
MT-198-S00	\$ 2,114.00	MT-198-S02	\$ 1,831.00	30" X 90" Table, 29"H	150
MT-144-S00	\$ 1,471.00	MT-144-S02	\$ 1,284.00	36" X 60" Table, 29"H	110
MT-138-S00	\$ 1,622.00	MT-138-S02	\$ 1,419.00	36" X 72" Table, 29"H	130
MT-146-S00	\$ 2,188.00	MT-146-S02	\$ 1,905.00	36" X 90" Table, 29"H	150
MT-145-S00	\$ 1,770.00	MT-145-S02	\$ 1,579.00	48" X 72" Table, 29"H	160
MT-134-S00	\$ 2,335.00	MT-134-S02	\$ 2,034.00	48" X 90" Table, 29"H	200

#### Optional Table Casters

MT-CASTER	\$ 25.00	Per Leg	Mobile leg attachment (Caster)
-----------	----------	---------	--------------------------------



#### Optional Wood Accent Strips for Tables

109-AK-S00	\$ 180.00	36" Diameter Table	5
129-AK-S00	\$ 180.00	42" Diameter Table	5
141-AK-S00	\$ 185.00	48" Diameter Table	5
191-AK-S00	\$ 126.00	30" Square Table	5
137-AK-S00	\$ 134.00	42" Square Table	5
154-AK-S00	\$ 147.00	48" Square Table	5
194-AK-S00	\$ 150.00	30" X 60" Table	5
195-AK-S00	\$ 165.00	30" X 72" Table	5
198-AK-S00	\$ 168.00	30" X 90" Table	5
144-AK-S00	\$ 156.00	36" X 60" Table	8
138-AK-S00	\$ 172.00	36" X 72" Table	8
146-AK-S00	\$ 172.00	36" X 90" Table	10
145-AK-S00	\$ 180.00	48" X 72" Table	10
134-AK-S00	\$ 185.00	48" X 90" Table	12

Please specify Wood Finish, Plastic Laminate, and Metal Color. Details can be found in the Product Options section at the front of this Price List.

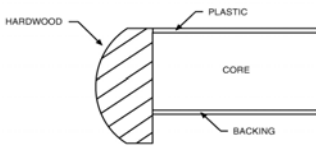

**M-Table (prices shown in Oak wood)  
Tables, Youth Height  
2009 Brodart Furniture - List Prices**

Plywood Core		Particleboard Core		Description	Weight (lbs)
Catalog Number	List Price	Catalog Number	List Price		

**Tables w/ Metal Legs, Youth Height**

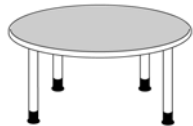
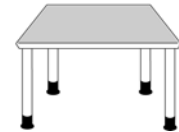
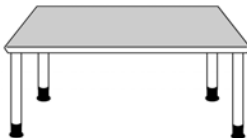
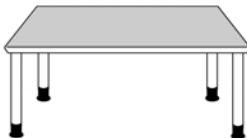
MT-Y09-S00	\$ 1,567.00	MT-Y09-S00	\$ 1,376.00	36" Diameter, 27 1/2"H		100
MT-Y29-S00	\$ 1,678.00	MT-Y29-S02	\$ 1,487.00	42" Diameter, 27 1/2"H		90
MT-Y41-S00	\$ 1,678.00	MT-Y41-S02	\$ 1,487.00	48" Diameter, 27 1/2"H		100
MT-Y91-S00	\$ 1,383.00	MT-Y91-S02	\$ 1,180.00	30" Square Table, 27 1/2"H		100
MT-Y37-S00	\$ 1,493.00	MT-Y37-S02	\$ 1,290.00	42" Square Table, 27 1/2"H		100
MT-Y54-S00	\$ 1,616.00	MT-Y54-S02	\$ 1,413.00	48" Square Table, 27 1/2"H		100
MT-Y94-S00	\$ 1,397.00	MT-Y94-S02	\$ 1,211.00	30" X 60" Table, 27 1/2"H		110
MT-Y95-S00	\$ 1,549.00	MT-Y95-S02	\$ 1,346.00	30" X 72" Table, 27 1/2"H		130
MT-Y98-S00	\$ 2,114.00	MT-Y98-S02	\$ 1,831.00	30" X 90" Table, 27 1/2"H		150
MT-Y44-S00	\$ 1,471.00	MT-Y44-S02	\$ 1,284.00	36" X 60" Table, 27 1/2"H		110
MT-Y38-S00	\$ 1,622.00	MT-Y38-S02	\$ 1,419.00	36" X 72" Table, 27 1/2"H		130
MT-Y46-S00	\$ 2,188.00	MT-Y46-S02	\$ 1,905.00	36" X 90" Table, 27 1/2"H		150
MT-Y45-S00	\$ 1,770.00	MT-Y45-S02	\$ 1,579.00	48" X 72" Table, 27 1/2"H		160
MT-Y34-S00	\$ 2,335.00	MT-Y34-S02	\$ 2,034.00	48" X 90" Table, 27 1/2"H		200

**Optional Table Casters**

MT-CASTER	\$ 25.00	Per Leg	Mobile leg attachment (Caster)
-----------	----------	---------	--------------------------------



**Optional Wood Accent Strips for Tables**

109-AK-S00	\$ 180.00	36" Diameter Table	5
129-AK-S00	\$ 180.00	42" Diameter Table	5
141-AK-S00	\$ 185.00	48" Diameter Table	5
191-AK-S00	\$ 126.00	30" Square Table	5
137-AK-S00	\$ 134.00	42" Square Table	5
154-AK-S00	\$ 147.00	48" Square Table	5
194-AK-S00	\$ 150.00	30" X 60" Table	5
195-AK-S00	\$ 165.00	30" X 72" Table	5
198-AK-S00	\$ 168.00	30" X 90" Table	5
144-AK-S00	\$ 156.00	36" X 60" Table	8
138-AK-S00	\$ 172.00	36" X 72" Table	8
146-AK-S00	\$ 172.00	36" X 90" Table	10
145-AK-S00	\$ 180.00	48" X 72" Table	10
134-AK-S00	\$ 185.00	48" X 90" Table	12

**Please specify Wood Finish, Plastic Laminate, and Metal Color. Details can be found in the Product Options section at the front of this Price List.**

# M-Table (prices shown in Oak wood)



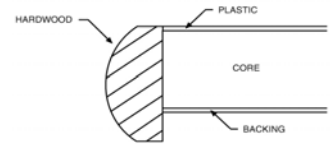

## Tables, Juvenile Height

### 2009 Brodart Furniture - List Prices

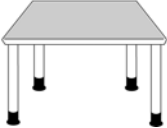

Plywood Core		Particleboard Core		Description	Weight (lbs)
Catalog Number	List Price	Catalog Number	List Price		

#### Tables w/ Metal Legs, Juvenile Height

MT-J09-S00	\$ 1,567.00	MT-J09-S00	\$ 1,376.00	36" Diameter, 25"H		100
MT-J29-S00	\$ 1,678.00	MT-J29-S02	\$ 1,487.00	42" Diameter, 25"H		90
MT-J41-S00	\$ 1,678.00	MT-J41-S02	\$ 1,487.00	48" Diameter, 25"H		100
MT-J91-S00	\$ 1,383.00	MT-J91-S02	\$ 1,180.00	30" Square Table, 25"H		100
MT-J37-S00	\$ 1,493.00	MT-J37-S02	\$ 1,290.00	42" Square Table, 25"H		100
MT-J54-S00	\$ 1,616.00	MT-J54-S02	\$ 1,413.00	48" Square Table, 25"H		100
MT-J94-S00	\$ 1,397.00	MT-J94-S02	\$ 1,211.00	30" X 60" Table, 25"H		110
MT-J95-S00	\$ 1,549.00	MT-J95-S02	\$ 1,346.00	30" X 72" Table, 25"H		130
MT-J98-S00	\$ 2,114.00	MT-J98-S02	\$ 1,831.00	30" X 90" Table, 25"H		150
MT-J44-S00	\$ 1,471.00	MT-J44-S02	\$ 1,284.00	36" X 60" Table, 25"H		110
MT-J38-S00	\$ 1,622.00	MT-J38-S02	\$ 1,419.00	36" X 72" Table, 25"H		130
MT-J46-S00	\$ 2,188.00	MT-J46-S02	\$ 1,905.00	36" X 90" Table, 25"H		150
MT-J45-S00	\$ 1,770.00	MT-J45-S02	\$ 1,579.00	48" X 72" Table, 25"H		160
MT-J34-S00	\$ 2,335.00	MT-J34-S02	\$ 2,034.00	48" X 90" Table, 25"H		200

#### Optional Table Casters

MT-CASTER	\$ 25.00	Per Leg	Mobile leg attachment (Caster)
-----------	----------	---------	--------------------------------



#### Optional Wood Accent Strips for Tables

109-AK-S00	\$ 180.00	36" Diameter Table	5
129-AK-S00	\$ 180.00	42" Diameter Table	5
141-AK-S00	\$ 185.00	48" Diameter Table	5
191-AK-S00	\$ 126.00	30" Square Table	5
137-AK-S00	\$ 134.00	42" Square Table	5
154-AK-S00	\$ 147.00	48" Square Table	5
194-AK-S00	\$ 150.00	30" X 60" Table	5
195-AK-S00	\$ 165.00	30" X 72" Table	5
198-AK-S00	\$ 168.00	30" X 90" Table	5
144-AK-S00	\$ 156.00	36" X 60" Table	8
138-AK-S00	\$ 172.00	36" X 72" Table	8
146-AK-S00	\$ 172.00	36" X 90" Table	10
145-AK-S00	\$ 180.00	48" X 72" Table	10
134-AK-S00	\$ 185.00	48" X 90" Table	12

Please specify Wood Finish, Plastic Laminate, and Metal Color. Details can be found in the Product Options section at the front of this Price List.







**Quorum 94T Series (prices shown in Oak wood)**

**Tables, Adult Height**

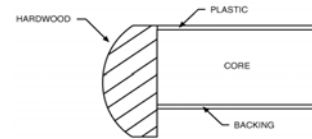
**2009 Brodart Furniture - List Prices**

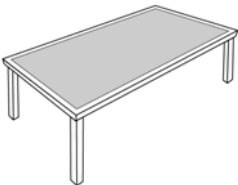

Plywood Core		Particleboard Core		Description	Weight (lbs)
Catalog Number	List Price	Catalog Number	List Price		
<b>Tables, Adult</b>					
94T-109-S00	\$ 1,354.00	94T-109-S02	\$ 1,188.00	36" Diameter, 29"H	
94T-129-S00	\$ 1,469.00	94T-129-S02	\$ 1,304.00	42" Diameter, 29"H	
94T-141-S00	\$ 1,469.00	94T-141-S02	\$ 1,304.00	48" Diameter, 29"H	
N/A	\$ -	94T-130-S02	\$ 1,736.00	60" Diameter, 29"H	
94T-191-S00	\$ 1,193.00	94T-191-S02	\$ 1,052.00	30" Square Table, 29"H	
94T-137-S00	\$ 1,309.00	94T-137-S02	\$ 1,133.00	42" Square Table, 29"H	
94T-154-S00	\$ 1,427.00	94T-154-S02	\$ 1,266.00	48" Square Table, 29"H	
94T-194-S00	\$ 1,221.00	94T-194-S02	\$ 1,045.00	30" X 60" Table, 29"H	
94T-195-S00	\$ 1,357.00	94T-195-S02	\$ 1,163.00	30" X 72" Table, 29"H	
94T-198-S00	\$ 1,851.00	94T-198-S02	\$ 1,620.00	30" X 90" Table, 29"H	
94T-144-S00	\$ 1,290.00	94T-144-S02	\$ 1,126.00	36" X 60" Table, 29"H	
94T-138-S00	\$ 1,415.00	94T-138-S02	\$ 1,244.00	36" X 72" Table, 29"H	
94T-146-S00	\$ 1,921.00	94T-146-S02	\$ 1,671.00	36" X 90" Table, 29"H	
94T-145-S00	\$ 1,553.00	94T-145-S02	\$ 1,383.00	48" X 72" Table, 29"H	
94T-134-S00	\$ 2,050.00	94T-134-S02	\$ 1,783.00	48" X 90" Table, 29"H	

**94 Series (full bullnose) Tables are available at a 35% price increases over 94T product**

**Optional Wood Accent Strips for Tables**

109-AK-S00	\$ 180.00	36" Diameter Table	5
129-AK-S00	\$ 180.00	42" Diameter Table	5
141-AK-S00	\$ 185.00	48" Diameter Table	5
130-AK-S00	\$ 197.00	60" Diameter Table	5
191-AK-S00	\$ 126.00	30" Square Table	5
137-AK-S00	\$ 134.00	42" Square Table	5
154-AK-S00	\$ 147.00	48" Square Table	5
194-AK-S00	\$ 150.00	30" X 60" Table	5
195-AK-S00	\$ 165.00	30" X 72" Table	5
198-AK-S00	\$ 168.00	30" X 90" Table	5
144-AK-S00	\$ 156.00	36" X 60" Table	8
138-AK-S00	\$ 172.00	36" X 72" Table	8
146-AK-S00	\$ 172.00	36" X 90" Table	10
145-AK-S00	\$ 180.00	48" X 72" Table	10
134-AK-S00	\$ 185.00	48" X 90" Table	12

**Please specify Wood Finish, and Plastic Laminate. Details can be found in the Product Options section at the front of this Price List.**

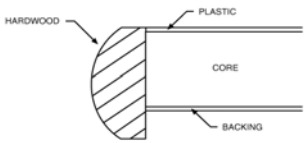

**Quorum 94T Series (prices shown in Oak wood)**

**Tables, Adult Height, Panel Base  
2009 Brodart Furniture - List Prices**

Plywood Core

Particleboard Core

Catalog Number	List Price	Catalog Number	List Price	Description	Weight (lbs)
----------------	------------	----------------	------------	-------------	--------------

**Tables, Adult-Panel Base**

94T-P44-S00	\$ 1,768.00	94T-P44-S02	\$ 1,568.00	36" X 60" Table, Panel Base, 29"H	145
94T-P38-S00	\$ 1,832.00	94T-P38-S02	\$ 1,608.00	36" X 72" Table, Panel Base, 29"H	158
94T-P46-S00	\$ 2,159.00	94T-P46-S02	\$ 1,929.00	36" X 90" Table, Panel Base, 29"H	178

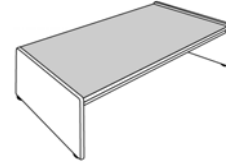

94T-P45-S00	\$ 2,218.00	94T-P45-S02	\$ 1,985.00	48" X 72" Table, Panel Base, 29"H	206
94T-P34-S00	\$ 2,223.00	94T-P34-S02	\$ 1,980.00	48" X 90" Table, Panel Base, 29"H	233

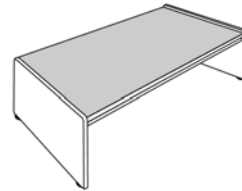

**94 Series (full bullnose) Tables are available at a 35% price increases over 94T product**



**Please specify Wood Finish, and Plastic Laminate. Details can be found in the Product Options section at the front of this Price List.**

# Quorum 94T Series (prices shown in Oak wood)

## Tables, Youth Height

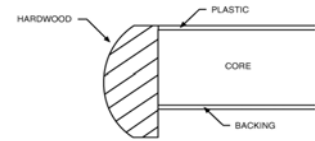
### 2009 Brodart Furniture - List Prices

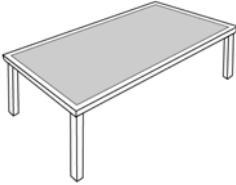

Plywood Core		Particleboard Core		Description	Weight (lbs)	
Catalog Number	List Price	Catalog Number	List Price			
<b>Tables, Youth</b>						
94T-Y09-S00	\$ 1,354.00	94T-Y09-S02	\$ 1,188.00	36" Diameter, 27 1/2"H		100
94T-Y29-S00	\$ 1,469.00	94T-Y29-S02	\$ 1,304.00	42" Diameter, 27 1/2"H		110
94T-Y41-S00	\$ 1,469.00	94T-Y41-S02	\$ 1,304.00	48" Diameter, 27 1/2"H		120
N/A	\$ -	94T-Y30-S02	\$ 1,687.00	60" Diameter, 27 1/2"H		140
94T-Y91-S00	\$ 1,309.00	94T-Y91-S02	\$ 1,133.00	30" Square Table, 27 1/2"H		110
94T-Y37-S00	\$ 1,309.00	94T-Y37-S02	\$ 1,133.00	42" Square Table, 27 1/2"H		110
94T-Y54-S00	\$ 1,427.00	94T-Y54-S02	\$ 1,266.00	48" Square Table, 27 1/2"H		110
94T-Y94-S00	\$ 1,221.00	94T-Y94-S02	\$ 1,045.00	30" X 60" Table, 27 1/2"H		120
94T-Y95-S00	\$ 1,357.00	94T-Y95-S02	\$ 1,163.00	30" X 72" Table, 27 1/2"H		140
94T-Y98-S00	\$ 1,851.00	94T-Y98-S02	\$ 1,620.00	30" X 90" Table, 27 1/2"H		165
94T-Y44-S00	\$ 1,290.00	94T-Y44-S02	\$ 1,126.00	36" X 60" Table, 27 1/2"H		120
94T-Y38-S00	\$ 1,415.00	94T-Y38-S02	\$ 1,244.00	36" X 72" Table, 27 1/2"H		140
94T-Y46-S02	\$ 1,921.00	94T-Y46-S00	\$ 1,671.00	36" X 90" Table, 27 1/2"H		160
94T-Y45-S00	\$ 1,553.00	94T-Y45-S02	\$ 1,383.00	48" X 72" Table, 27 1/2"H	170	
94T-Y34-S02	\$ 2,050.00	94T-Y34-S00	\$ 1,783.00	48" X 90" Table, 27 1/2"H	185	

**94 Series (full bullnose) Tables are available at a 35% price increases over 94T product**

#### Optional Wood Accent Strips for Tables

109-AK-S00	\$ 180.00	36" Diameter Table	5
129-AK-S00	\$ 180.00	42" Diameter Table	5
141-AK-S00	\$ 185.00	48" Diameter Table	5
130-AK-S00	\$ 197.00	60" Diameter Table	5
191-AK-S00	\$ 126.00	30" Square Table	5
137-AK-S00	\$ 134.00	42" Square Table	5
154-AK-S00	\$ 147.00	48" Square Table	5
194-AK-S00	\$ 150.00	30" X 60" Table	5
195-AK-S00	\$ 165.00	30" X 72" Table	5
198-AK-S00	\$ 168.00	30" X 90" Table	5
144-AK-S00	\$ 156.00	36" X 60" Table	8
138-AK-S00	\$ 172.00	36" X 72" Table	8
146-AK-S00	\$ 172.00	36" X 90" Table	10
145-AK-S00	\$ 180.00	48" X 72" Table	10
134-AK-S00	\$ 185.00	48" X 90" Table	12

**Please specify Wood Finish, and Plastic Laminate. Details can be found in the Product Options section at the front of this Price List.**

**Quorum 94T Series (prices shown in Oak wood)**

**Tables, Juvenile Height  
2009 Brodart Furniture - List Prices**

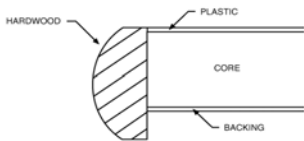

Plywood Core

Particleboard Core

Catalog Number	List Price	Catalog Number	List Price	Description	Weight (lbs)
<b>Tables, Juvenile</b>					
94T-J09-S00	\$ 1,354.00	94T-J09-S02	\$ 1,188.00	36" Diameter, 25"H	100
94T-J29-S00	\$ 1,469.00	94T-J29-S02	\$ 1,304.00	42" Diameter, 25"H	110
94T-J41-S00	\$ 1,469.00	94T-J41-S02	\$ 1,304.00	48" Diameter, 25"H	120
N/A	\$ -	94T-J30-S02	\$ 1,687.00	60" Diameter, 25"H	140
94T-J91-S00	\$ 1,309.00	94T-J91-S02	\$ 1,133.00	30" Square Table, 25"H	110
94T-J37-S00	\$ 1,309.00	94T-J37-S02	\$ 1,133.00	42" Square Table, 25"H	100
94T-J54-S00	\$ 1,427.00	94T-J54-S02	\$ 1,266.00	48" Square Table, 25"H	110
94T-J94-S00	\$ 1,221.00	94T-J94-S02	\$ 1,045.00	30" X 60" Table, 25"H	120
94T-J95-S00	\$ 1,357.00	94T-J95-S02	\$ 1,163.00	30" X 72" Table, 25"H	140
94T-J98-S00	\$ 1,851.00	94T-J98-S02	\$ 1,620.00	30" X 90" Table, 25"H	165
94T-J44-S00	\$ 1,290.00	94T-J44-S02	\$ 1,126.00	36" X 60" Table, 25"H	120
94T-J38-S00	\$ 1,415.00	94T-J38-S02	\$ 1,244.00	36" X 72" Table, 25"H	140
94T-J46-S02	\$ 1,921.00	94T-J46-S00	\$ 1,671.00	36" X 90" Table, 25"H	160
94T-J45-S00	\$ 1,553.00	94T-J45-S02	\$ 1,383.00	48" X 72" Table, 25"H	170
94T-J34-S02	\$ 2,050.00	94T-J34-S00	\$ 1,783.00	48" X 90" Table, 25"H	185

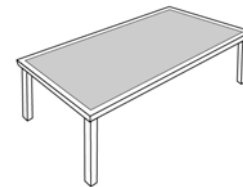

**94 Series (full bullnose) Tables are available at a 35% price increases over 94T product**

**Optional Wood Accent Strips for Tables**

109-AK-S00	\$ 180.00	36" Diameter Table	5
129-AK-S00	\$ 180.00	42" Diameter Table	5
141-AK-S00	\$ 185.00	48" Diameter Table	5
130-AK-S00	\$ 197.00	60" Diameter Table	5
191-AK-S00	\$ 126.00	30" Square Table	5
137-AK-S00	\$ 134.00	42" Square Table	5
154-AK-S00	\$ 147.00	48" Square Table	5
194-AK-S00	\$ 150.00	30" X 60" Table	5
195-AK-S00	\$ 165.00	30" X 72" Table	5
198-AK-S00	\$ 168.00	30" X 90" Table	5
144-AK-S00	\$ 156.00	36" X 60" Table	8
138-AK-S00	\$ 172.00	36" X 72" Table	8
146-AK-S00	\$ 172.00	36" X 90" Table	10
145-AK-S00	\$ 180.00	48" X 72" Table	10
134-AK-S00	\$ 185.00	48" X 90" Table	12

**Please specify Wood Finish, and Plastic Laminate. Details can be found in the Product Options section at the front of this Price List.**

**Table Modifications & Up Charges**  
**2009 Brodart Furniture - List Prices**

Catalog Number	List Price	Description	Weight (lbs)
----------------	------------	-------------	--------------

**Casters for Tables**

LG-CST-S00	\$ 76.00	Caster to Convert Table to be Mobile-Includes a Brake (Price is per Leg)	
------------	----------	--	--



\* Casters are Available for the M-Table series in the M-Table Section of this Price List

**Cut Down in Dimension of Leg Base Tables**

\$ 157.00	1 Dimension Cut Down
\$ 223.00	2 Dimension Cut Down

**Cut Down in Dimension of Apron/Panel Base Tables**

\$ 288.00	1 Dimension Cut Down
\$ 419.00	2 Dimension Cut Down

**Change Standard HPL to Marmoleum**

25% Per Table

**Change Standard Top/Edge Band to Corian**

Please Call for Pricing

**Continuum 64 series furniture is available at 5% additional charge to 4W series prices**



**Berwyn Collection (prices shown in Cherry wood)**

**Computer Furniture**

**2009 Brodart Furniture - List Prices**

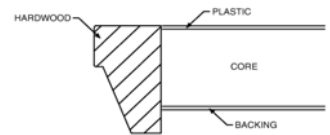

Catalog Number      List Price      Description Weight (lbs)

**Single Faced Modular Study Carrels**

**36" Wide Work Surface**

- 66-160-S00      \$    4,304.00      S/F Starter, 33 1/4" x 39" x 50 1/4"H
- 66-159-S00      \$    2,361.00      S/F Adder, 33 1/4" x 37 1/4" x 50 1/4"H

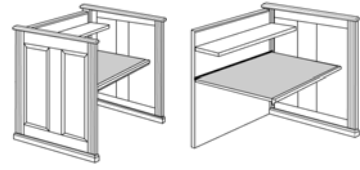

- 170
- 120

**48" Wide Work Surface**

- 66-560-S00      \$    4,462.00      S/F Starter, 33 1/4" x 51" x 50 1/4"H
- 66-559-S00      \$    2,529.00      S/F Adder, 33 1/4" x 49 1/4" x 50 1/4"H



- 200
- 150

**Double Faced Modular Study Carrels**

**36" Wide Work Surface**

- 66-161-S00      \$    8,177.00      D/F Starter, 64" x 39" x 50 1/4"H
- 66-162-S00      \$    4,268.00      D/F Adder, 64" x 37 1/4" x 50 1/4"H

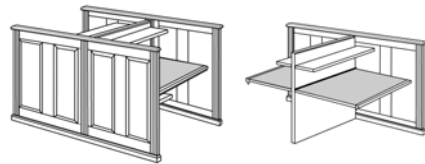

- 320
- 220

**48" Wide Work Surface**

- 66-561-S00      \$    8,399.00      D/F Starter, 64" x 51" x 50 1/4"H
- 66-562-S00      \$    4,469.00      D/F Adder, 64" x 49 1/4" x 50 1/4"H



- 380
- 280

**Single Faced Information Access Carrels/Workstations**

**36" Wide Work Surface**

- 66-673-S00      \$    4,304.00      S/F Starter, 33 1/4" x 39" x 50 1/4"H
- 66-672-S00      \$    2,361.00      S/F Adder, 33 1/4" x 37 1/4" x 50 1/4"H

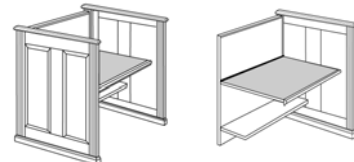

- 170
- 120

**48" Wide Work Surface**

- 66-460-S00      \$    4,462.00      S/F Starter, 33 1/4" x 51" x 50 1/4"H
- 66-459-S00      \$    2,529.00      S/F Adder, 33 1/4" x 49 1/4" x 50 1/4"H



- 200
- 150

**Double Faced Information Access Carrels/Workstations**

**36" Wide Work Surface**

- 66-674-S00      \$    8,177.00      D/F Starter, 64" x 39" x 50 1/4"H
- 66-675-S00      \$    4,268.00      D/F Adder, 64" x 37 1/4" x 50 1/4"H

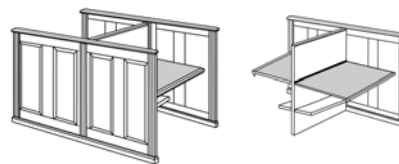

- 320
- 220

**48" Wide Work Surface**

- 66-461-S00      \$    8,399.00      D/F Starter, 64" x 51" x 50 1/4"H
- 66-462-S00      \$    4,469.00      D/F Adder, 64" x 49 1/4" x 50 1/4"H



- 380
- 280

**Please specify Wood Finish and Plastic Laminate. Details can be found in the Product Options section at the front of this Price List.**



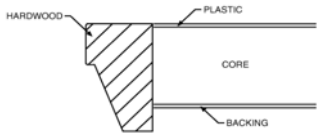

**Berwyn Collection (prices shown in Cherry wood)  
Computer Furniture  
2009 Brodart Furniture - List Prices**

Catalog Number	List Price	Description	Weight (lbs)
----------------	------------	-------------	--------------

**Public Access Computer Stations w/ Adjustable Height Worksurface**

66-685-S00	\$ 9,016.00	Three Position Access Station, 48 1/2" x 100 1/2" x 42" H
------------	-------------	---

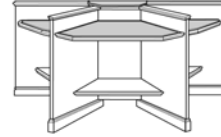

300

66-682-S00	\$ 16,590.00	Six Position Access Station, 100 1/2" x 100 1/2" x 42" H
------------	--------------	--

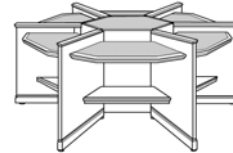

510

**Please specify Wood Finish and Plastic Laminate. Details can be found in the Product Options section at the front of this Price List.**

**Chancellor's Collection (prices shown in Oak wood)**

**Computer Furniture**

**2009 Brodart Furniture - List Prices**

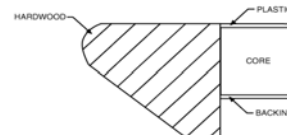

Catalog Number	List Price	Description	Weight (lbs)
----------------	------------	-------------	--------------

**Information Access Tables w/o Superstructure**

**Sitting Height, Chamfered Square Leg Design**

CH2-645-S00	\$ 1,498.00	One Position, 26 1/4" x 32 1/4" x 27 1/2"H
CH2-665-S00	\$ 1,786.00	One Position, 32 1/4" x 32 1/4" x 27 1/2"H
CH2-649-S00	\$ 2,321.00	Two Position, 26 1/4" x 62 1/4" x 27 1/2"H
CH2-669-S00	\$ 2,419.00	Two Position, 32 1/4" x 62 1/4" x 27 1/2"H



**Information Access Tables w/ 10"H Back Panel**

**Sitting Height, Chamfered Square Leg Design**

CH2-643-S00	\$ 1,826.00	One Position, 26 1/4" x 38 3/4" x 27 1/2"H
CH2-663-S00	\$ 1,917.00	One Position, 38 3/4" x 38 3/4" x 27 1/2"H
CH2-642-S00	\$ 2,615.00	Two Position, 26 1/4" x 74 3/4" x 27 1/2"H
CH2-662-S00	\$ 2,745.00	Two Position, 38 3/4" x 74 3/4" x 27 1/2"H
CH2-644-S00	\$ 3,136.00	Three Position, 26 1/4" x 92 3/4" x 27 1/2"H
CH2-664-S00	\$ 3,332.00	Three Position, 38 3/4" x 92 3/4" x 27 1/2"H

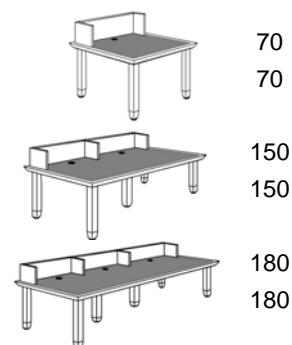

**Standing Height, Chamfered Square Leg Design**

CH2-643-S05	\$ 1,982.00	One Position, 26 1/4" x 38 3/4" x 39"H
CH2-663-S05	\$ 2,073.00	One Position, 38 3/4" x 38 3/4" x 39"H
CH2-642-S05	\$ 2,849.00	Two Position, 26 1/4" x 74 3/4" x 39"H
CH2-662-S05	\$ 2,980.00	Two Position, 38 3/4" x 74 3/4" x 39"H
CH2-644-S05	\$ 3,462.00	Three Position, 26 1/4" x 92 3/4" x 39"H
CH2-664-S05	\$ 3,658.00	Three Position, 38 3/4" x 92 3/4" x 39"H

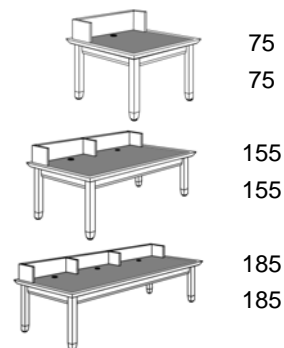

Please specify Wood Finish and Plastic Laminate. Details can be found in the Product Options section at the front of this Price List.

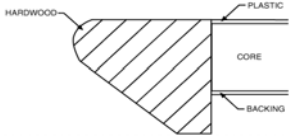

**Chancellor's Collection (prices shown in Oak wood)  
Computer Furniture  
2009 Brodart Furniture - List Prices**

Catalog Number	List Price	Description	Weight (lbs)
----------------	------------	-------------	--------------

**Single Faced Modular Study Carrels**

**36" Wide Work Surface**

CH2-160-S00	\$ 3,117.00	S/F Starter, 32 1/2" x 39 1/2" x 49" H
CH2-159-S00	\$ 2,347.00	S/F Adder, 32 1/2" x 37 3/4" x 49" H

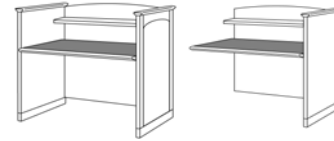

165  
115

**Double Faced Modular Study Carrels**

**36" Wide Work Surface**

CH2-161-S00	\$ 4,479.00	D/F Starter, 61 1/4" x 39 1/2" x 49" H
CH2-162-S00	\$ 3,286.00	D/F Adder, 61 1/4" x 37 3/4" x 49" H

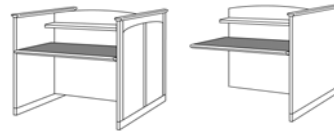

305  
205

**Single Faced Information Access Carrels/Workstations**

**36" Wide Work Surface**

CH2-673-S00	\$ 3,117.00	S/F Starter, 32 1/2" x 39 1/2" x 49" H
CH2-672-S00	\$ 2,347.00	S/F Adder, 32 1/2" x 37 3/4" x 49" H

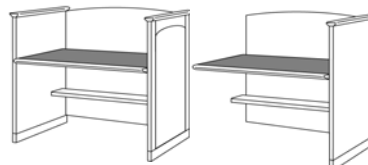

165  
115

**48" Wide Work Surface**

CH2-460-S00	\$ 3,377.00	S/F Starter, 32 1/2" x 51 1/2" x 49" H
CH2-459-S00	\$ 2,699.00	S/F Adder, 32 1/2" x 49 3/4" x 49" H

195  
145

**Double Faced Information Access Carrels/Workstations**

**36" Wide Work Surface**

CH2-674-S00	\$ 4,479.00	D/F Starter, 61 1/4" x 39 1/2" x 49" H
CH2-675-S00	\$ 3,286.00	D/F Adder, 61 1/4" x 37 3/4" x 49" H

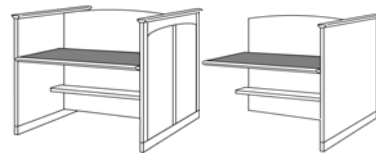

306  
205

**48" Wide Work Surface**

CH2-461-S00	\$ 5,040.00	D/F Starter, 61 1/4" x 51 1/2" x 49" H
CH2-462-S00	\$ 3,860.00	D/F Adder, 61 1/4" x 49 3/4" x 49" H

366  
265

**Please specify Wood Finish and Plastic Laminate. Details can be found in the Product Options section at the front of this Price List.**

**Chancellor's Collection (prices shown in Oak wood)**

**Computer Furniture**

**2009 Brodart Furniture - List Prices**

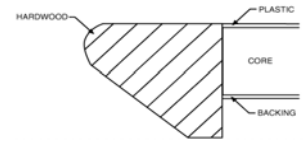

Catalog Number	List Price	Description	Weight (lbs)
----------------	------------	-------------	--------------

**Single Faced Modular LTS (Library Technology Stations)**

**36" Wide Work Surface**

CH2-S31-SS0	\$ 3,016.00	S/F One position starter, 31" x 37 1/2" x 36"H	130
CH2-S31-SA0	\$ 2,000.00	S/F One position adder, 31" x 36 1/2" x 36"H	100

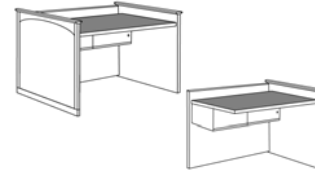

**48" Wide Work Surface**

CH2-S41-SS0	\$ 3,157.00	S/F One position starter, 31" x 49 1/4" x 36"H	155
CH2-S41-SA0	\$ 2,054.00	S/F One position adder, 31" x 48" x 36"H	125

**36" Wide Work Surface**

CH2-S32-SS0	\$ 3,999.00	S/F Two position starter, 31" x 74" x 36"H	195
CH2-S32-SA0	\$ 2,994.00	S/F Two position adder, 31" x 73" x 36"H	165

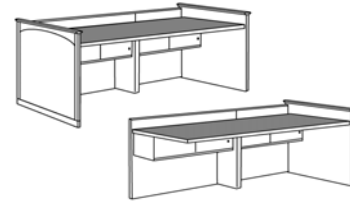

**48" Wide Work Surface**

CH2-S42-SS0	\$ 4,260.00	S/F Two position starter, 31" x 97 1/4" x 36"H	235
CH2-S42-SA0	\$ 3,157.00	S/F Two position adder, 31" x 96" x 36"H	205

**36" Wide Work Surface**

CH2-S33-SS0	\$ 5,060.00	S/F Three position starter, 31" x 110 1/2" x 36"H	260
CH2-S33-SA0	\$ 3,946.00	S/F Three position adder, 31" x 109 1/4" x 36"H	230

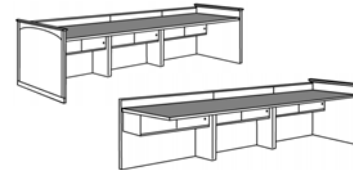

**Double Faced Modular LTS (Library Technology Stations)**

**36" Wide Work Surface**

CH2-D31-SS0	\$ 4,517.00	D/F One position starter, 59 1/2" x 37 1/2" x 36"H	155
CH2-D31-SA0	\$ 3,205.00	D/F One position adder, 59 1/2" x 36 1/2" x 36"H	155



**48" Wide Work Surface**

CH2-D41-SS0	\$ 4,755.00	D/F One position starter, 59 1/2" x 49 1/4" x 36"H	195
CH2-D41-SA0	\$ 3,367.00	D/F One position adder, 59 1/2" x 48" x 36"H	195

**36" Wide Work Surface**

CH2-D32-SS0	\$ 6,028.00	D/F Two position starter, 59 1/2" x 74" x 36"H	330
CH2-D32-SA0	\$ 4,782.00	D/F Two position adder, 59 1/2" x 73" x 36"H	270

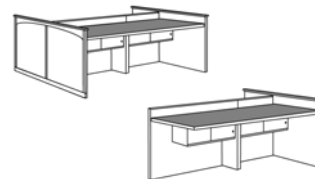

**48" Wide Work Surface**

CH2-D42-SS0	\$ 5,106.00	D/F Two position starter, 59 1/2" x 97 1/4" x 36"H	355
CH2-D42-SA0	\$ 6,443.00	D/F Two position adder, 59 1/2" x 96" x 36"H	355

**36" Wide Work Surface**



CH2-D33-SS0	\$ 6,530.00	D/F Three position starter, 59 1/2" x 110 1/2" x 36"H	445
CH2-D33-SA0	\$ 7,781.00	D/F Three position adder, 59 1/2" x 109 1/4" x 36"H	385

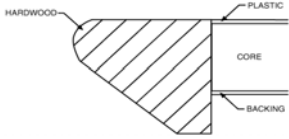

**Please specify Wood Finish and Plastic Laminate. Details can be found in the Product Options section at the front of this Price List.**

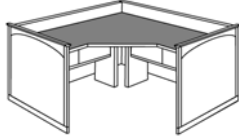
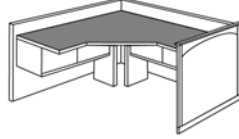
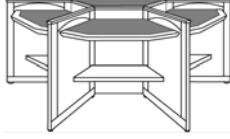

**Chancellor's Collection (prices shown in Oak wood)  
Computer Furniture  
2009 Brodart Furniture - List Prices**

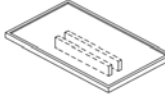
Catalog Number	List Price	Description		Weight (lbs)
<b>90 Degree Corner Units</b>				
CH2-SCR-SS0	\$ 6,465.00	Functional corner starter, 31" x 62" x 36"H		225
CH2-SCR-SA0	\$ 5,329.00	Functional corner adder, 31" x 62" x 36"H		195
<b>Public Access Computer Stations w/ Adjustable Height Work Surface</b>				
CH2-685-S00	\$ 8,541.00	Three Position Access Station, 47 1/2" x 98 1/2" x 43 1/2" H		265
CH2-682-S00	\$ 15,811.00	Six Position Access Station, 98 1/2" x 98 1/2" x 43 1/2" H		500
64-694-S00	\$ 428.00	Movable Printer Shelf for PAC Stations		10

**Please specify Wood Finish and Plastic Laminate. Details can be found in the Product Options section at the front of this Price List.**

# Epoch Collection (prices shown in Maple wood)

## Computer Furniture

### 2009 Brodart Furniture - List Prices

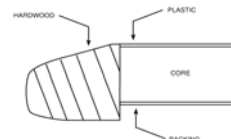

Catalog Number	List Price	Description	Weight (lbs)
----------------	------------	-------------	--------------

#### Information Access Tables w/o Superstructure

##### Powder Coated Legs

59-645-S00	\$ 2,324.00	One Position, 26 1/4" x 32 1/4" x 27 1/2"H	80
------------	-------------	--	----

59-665-S00	\$ 2,382.00	One Position, 32 1/4" x 32 1/4" x 27 1/2"H	80
------------	-------------	--	----

##### Chrome Legs

59C-645-S00	\$ 3,019.00	One Position, 26 1/4" x 32 1/4" x 27 1/2"H	80
-------------	-------------	--	----

59C-665-S00	\$ 3,077.00	One Position, 32 1/4" x 32 1/4" x 27 1/2"H	80
-------------	-------------	--	----



##### Powder Coated Legs

59-649-S00	\$ 3,153.00	Two Position, 26 1/4" x 62 1/4" x 27 1/2"H	110
------------	-------------	--	-----

59-669-S00	\$ 3,211.00	Two Position, 32 1/4" x 62 1/4" x 27 1/2"H	110
------------	-------------	--	-----

##### Chrome Legs

59C-649-S00	\$ 3,848.00	Two Position, 26 1/4" x 62 1/4" x 27 1/2"H	110
-------------	-------------	--	-----

59C-669-S00	\$ 3,906.00	Two Position, 32 1/4" x 62 1/4" x 27 1/2"H	110
-------------	-------------	--	-----



#### Information Access Tables w/ 10"H Back Panel

##### Powder coated legs

59-643-S00	\$ 2,463.00	One Position, 26 1/4" x 38 3/4" x 27 1/2"H	70
------------	-------------	--	----

59-663-S00	\$ 2,544.00	One Position, 38 3/4" x 38 3/4" x 27 1/2"H	70
------------	-------------	--	----

##### Chrome Legs

59C-643-S00	\$ 3,158.00	One Position, 26 1/4" x 38 3/4" x 27 1/2"H	70
-------------	-------------	--	----

59C-663-S00	\$ 3,190.00	One Position, 38 3/4" x 38 3/4" x 27 1/2"H	70
-------------	-------------	--	----

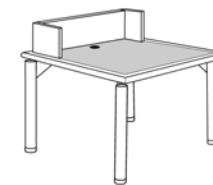

##### Powder coated legs

59-642-S00	\$ 3,304.00	Two Position, 26 1/4" x 74 3/4" x 27 1/2"H	150
------------	-------------	--	-----

59-662-S00	\$ 3,385.00	Two Position, 38 3/4" x 74 3/4" x 27 1/2"H	150
------------	-------------	--	-----

##### Chrome Legs

59C-642-S00	\$ 3,999.00	Two Position, 26 1/4" x 74 3/4" x 27 1/2"H	150
-------------	-------------	--	-----

59C-662-S00	\$ 4,192.00	Two Position, 38 3/4" x 74 3/4" x 27 1/2"H	150
-------------	-------------	--	-----

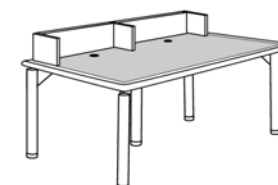

##### Powder coated legs

59-644-S00	\$ 3,049.00	Three Position, 26 1/4" x 92 3/4" x 27 1/2"H	180
------------	-------------	--	-----

59-664-S00	\$ 4,230.00	Three Position, 38 3/4" x 92 3/4" x 27 1/2"H	180
------------	-------------	--	-----

##### Chrome Legs

59C-644-S00	\$ 3,744.00	Three Position, 26 1/4" x 92 3/4" x 27 1/2"H	180
-------------	-------------	--	-----

59C-664-S00	\$ 5,199.00	Three Position, 38 3/4" x 92 3/4" x 27 1/2"H	180
-------------	-------------	--	-----

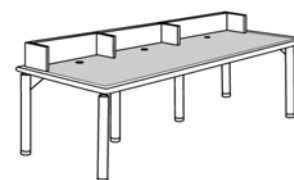

**Note:** All Epoch Tables now come standard with the angle bracket cut out design.



Please specify Wood Finish, Plastic Laminate, and Metal Color (where applicable). Details can be found in the Product Options section at the front of this Price List.

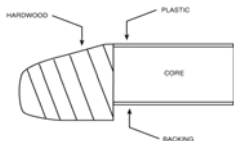

Catalog Number	List Price	Description	Weight (lbs)
----------------	------------	-------------	--------------

**Single Faced Information Access Carrels/Workstations**

**36" Wide Work Surface**

59-673-S00 \$ 3,928.00 S/F Starter, 33" x 38 1/4" x 47 1/2"H

59-672-S00 \$ 2,054.00 S/F Adder, 33" x 37 1/4" x 47 1/2"H

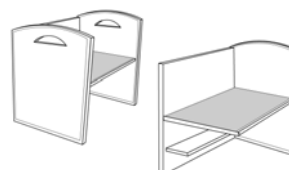

165

115

**48" Wide Work Surface**

59-460-S00 \$ 4,068.00 S/F Starter, 33" x 50" x 47 1/2"H

59-459-S00 \$ 2,213.00 S/F Adder, 33" x 48 3/4" x 47 1/2"H

195

145

**Double Faced Information Access Carrels/Workstations**

**36" Wide Work Surface**

59-674-S00 \$ 7,608.00 D/F Starter, 66 1/4" x 38 1/4" x 47 1/2"H

59-675-S00 \$ 4,400.00 D/F Adder, 66 1/4" x 37 1/4" x 47 1/2"H

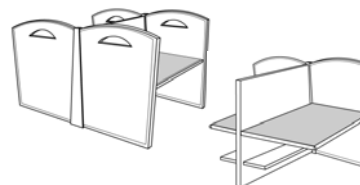

306

205

**48" Wide Work Surface**

59-461-S00 \$ 8,038.00 D/F Starter, 66 1/4" x 50" x 47 1/2"H

59-462-S00 \$ 4,322.00 D/F Adder, 66 1/4" x 48 3/4" x 47 1/2"H

366

265

**Computer Workstations**

59-822-S00 \$ 6,020.00 S/F Two position, 46 3/4" x 60" x 47 1/2"H

59-824-S00 \$ 10,871.00 D/F Four position, 90 3/16" x 60" x 47 1/2"H



290

480

**Public Access Computer Stations w/ Adjustable Height Work Surface**

59-685-S00 \$ 7,168.00 Three position station, 50 3/4" x 101 1/2" x 45 1/4"H

59-682-S00 \$ 11,484.00 Six position station, 101 1/2" x 101 1/2" x 45 1/4"H

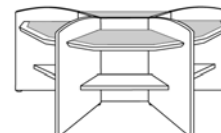

265

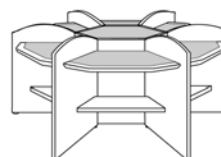

500

**OPAC Station, 33" x 26 1/4" x 48 1/4"**

59GP-039-S00 \$ 3,400.00 OPAC Station w/ Glass Window and Painted Accent

59GC-039-S00 \$ 4,003.00 OPAC Station w/ Glass Window and Chrome Accent



110

110

59TP-039-S00 \$ 2,547.00 OPAC Station w/ Painted Metal Accents

59TC-039-S00 \$ 3,466.00 OPAC Station w/ Chrome Metal Accents











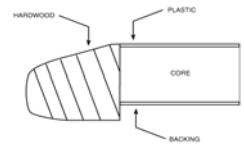



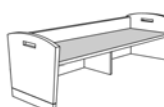
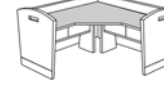

110

110

Please specify Wood Finish, Plastic Laminate, Metal Color, and Glass (where applicable). Details can be found in the Product Options section at the front of this Price List.

**Epoch Collection (prices shown in Maple wood)  
Single Faced Modular LTS (Library Technology Stations)  
2009 Brodart Furniture - List Prices**











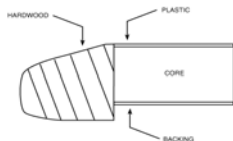



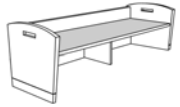
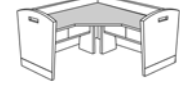

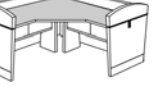
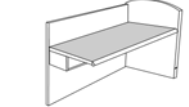

Catalog Number	List Price	Description		Weight (lbs)
<b>Glass Window and Painted Accent</b>				
<b>36" Wide Work Surface</b>				
59GP-S31-SS0	\$ 3,157.00	S/F One position starter, 33 1/4" x 37 1/2" x 37"H		130
<b>48" Wide Work Surface</b>				
59GP-S41-SS0	\$ 3,326.00	S/F One position starter, 33 1/4" x 49 1/4" x 37"H		155
<b>36" Wide Work Surface</b>				
59GP-S32-SS0	\$ 4,169.00	S/F Two position starter, 33 1/4" x 74" x 37"H		195
<b>48" Wide Work Surface</b>				
59GP-S42-SS0	\$ 4,449.00	S/F Two position starter, 33 1/4" x 97 1/4" x 37"H		235
<b>36" Wide Work Surface</b>				
59GP-S33-SS0	\$ 5,269.00	S/F Three position starter, 33 1/4" x 110 1/2" x 37"H		260
<b>90 Degree Corner Unit</b>				
59GP-SCR-SS0	\$ 6,713.00	w/ Glass and Painted Metal Accent, 33 1/4" x 62" x 37"H		225
<b>Painted Metal T-Strip and Accent</b>				
<b>36" Wide Work Surface</b>				
59TP-S31-SS0	\$ 2,683.00	S/F One position starter, 33 1/4" x 37 1/2" x 37"H		130
<b>48" Wide Work Surface</b>				
59TP-S41-SS0	\$ 2,827.00	S/F One position starter, 33 1/4" x 49 1/4" x 37"H		155
<b>36" Wide Work Surface</b>				
59TP-S32-SS0	\$ 3,543.00	S/F Two position starter, 33 1/4" x 74" x 37"H		195
<b>48" Wide Work Surface</b>				
59TP-S42-SS0	\$ 3,782.00	S/F Two position starter, 33 1/4" x 97 1/4" x 37"H		235
<b>36" Wide Work Surface</b>				
59TP-S33-SS0	\$ 4,479.00	S/F Three position starter, 33 1/4" x 110 1/2" x 37"H		260
<b>90 Degree Corner Unit</b>				
59TP-SCR-SS0	\$ 5,705.00	w/ Painted Metal T-Strip and Accent, 33 1/4" x 62" x 37"H		225
<b>Single Faced Adder Units (no styling)</b>				
<b>36" Wide Work Surface</b>				
59-S31-SA0	\$ 2,116.00	S/F One position adder, 33 1/4" x 36 1/2" x 37"H		100
<b>48" Wide Work Surface</b>				
59-S41-SA0	\$ 2,176.00	S/F One position adder, 33 1/4" x 48" x 37"H		125
<b>36" Wide Work Surface</b>				
59-S32-SA0	\$ 3,143.00	S/F Two position adder, 33 1/4" x 73" x 37"H		165
<b>48" Wide Work Surface</b>				
56-S42-SA0	\$ 3,308.00	S/F Two position adder, 33 1/4" x 96" x 37"H		205
<b>36" Wide Work Surface</b>				
59-S33-SA0	\$ 4,120.00	S/F Three position adder, 33 1/4" x 109 1/4" x 37"H		230
<b>90 Degree Corner Unit</b>				
59-SCR-SA0	\$ 5,561.00	Functional corner adder, 33 1/4" x 62 x 37"H		195

Please specify Wood Finish, Plastic Laminate, Metal Color, and Glass (where applicable). Details can be found in the Product Options section at the front of this Price List.

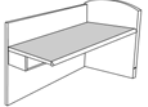

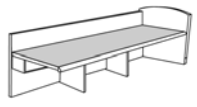
**Epoch Collection (prices shown in Maple wood)  
Single Faced Modular LTS (Library Technology Stations)  
2009 Brodart Furniture - List Prices**

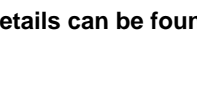







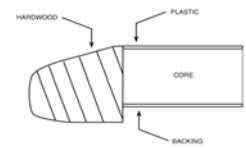

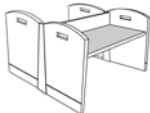

Catalog Number	List Price	Description		Weight (lbs)
<b>Glass Window and Chrome Accent</b>				
<b>36" Wide Work Surface</b>				
59GC-S31-SS0	\$ 3,662.00	S/F One position starter, 33 1/4" x 37 1/2" x 37"H		130
<b>48" Wide Work Surface</b>				
59GC-S41-SS0	\$ 3,858.00	S/F One position starter, 33 1/4" x 49 1/4" x 37"H		155
<b>36" Wide Work Surface</b>				
59GC-S32-SS0	\$ 4,836.00	S/F Two position starter, 33 1/4" x 74" x 37"H		195
<b>48" Wide Work Surface</b>				
59GC-S42-SS0	\$ 5,161.00	S/F Two position starter, 33 1/4" x 97 1/4" x 37"H		235
<b>36" Wide Work Surface</b>				
59GC-S33-SS0	\$ 6,112.00	S/F Three position starter, 33 1/4" x 110 1/2" x 37"H		260
<b>90 Degree Corner Unit</b>				
59GC-SCR-SS0	\$ 7,788.00	w/ Glass and Chrome Metal Accent, 33 1/4" x 62" x 37"H		225
<b>Chrome T-Strip and Accent</b>				
<b>36" Wide Work Surface</b>				
59TC-S31-SS0	\$ 3,251.00	S/F One position starter, 33 1/4" x 37 1/2" x 37"H		130
<b>48" Wide Work Surface</b>				
59TC-S41-SS0	\$ 3,426.00	S/F One position starter, 33 1/4" x 49 1/4" x 37"H		155
<b>36" Wide Work Surface</b>				
59TC-S32-SS0	\$ 4,294.00	S/F Two position starter, 33 1/4" x 74" x 37"H		195
<b>48" Wide Work Surface</b>				
59TC-S42-SS0	\$ 4,583.00	S/F Two position starter, 33 1/4" x 97 1/4" x 37"H		235
<b>36" Wide Work Surface</b>				
59TC-S33-SS0	\$ 5,427.00	S/F Three position starter, 33 1/4" x 110 1/2" x 37"H		260
<b>90 Degree Corner Unit</b>				
59TC-SCR-SS0	\$ 6,914.00	w/ Chrome T-Strip and Accent, 33 1/4" x 62" x 37"H		225
<b>Single Faced Adder Units (no styling)</b>				
<b>36" Wide Work Surface</b>				
59-S31-SA0	\$ 2,116.00	S/F One position adder, 33 1/4" x 36 1/2" x 37"H		100
<b>48" Wide Work Surface</b>				
59-S41-SA0	\$ 2,176.00	S/F One position adder, 33 1/4" x 48" x 37"H		125
<b>36" Wide Work Surface</b>				
59-S32-SA0	\$ 3,143.00	S/F Two position adder, 33 1/4" x 73" x 37"H		165
<b>48" Wide Work Surface</b>				
56-S42-SA0	\$ 3,308.00	S/F Two position adder, 33 1/4" x 96" x 37"H		205
<b>36" Wide Work Surface</b>				
59-S33-SA0	\$ 4,120.00	S/F Three position adder, 33 1/4" x 109 1/4" x 37"H		230
<b>90 Degree Corner Unit</b>				
59-SCR-SA0	\$ 5,561.00	Functional corner adder, 33 1/4" x 62 x 37"H		195

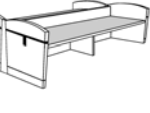
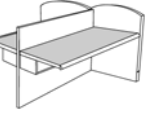
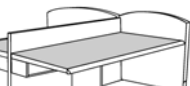
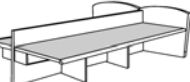
**Please specify Wood Finish, Plastic Laminate, Metal Color, and Glass (where applicable). Details can be found in the Product Options section at the front of this Price List.**

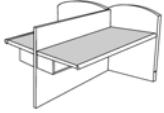
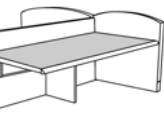
**Epoch Collection (prices shown in Maple wood)**  
**Double Faced Modular LTS (Library Technology Stations)**  
**2009 Brodart Furniture - List Prices**



Catalog Number	List Price	Description		Weight (lbs)
<b>Glass Window and Painted Accent</b>				
<b>36" Wide Work Surface</b>				
59GP-D31-SS0	\$ 4,727.00	D/F One position starter, 63 1/2" x 37 1/2" x 37"H		155
<b>48" Wide Work Surface</b>				
59GP-D41-SS0	\$ 5,008.00	D/F One position starter, 63 1/2" x 49 1/4" x 37"H		195
<b>36" Wide Work Surface</b>				
59GP-D32-SS0	\$ 6,283.00	D/F Two position starter, 63 1/2" x 74" x 37"H		330
<b>48" Wide Work Surface</b>				
59GP-D42-SS0	\$ 6,485.00	D/F Two position starter, 63 1/2" x 97 1/4" x 37"H		355
<b>36" Wide Work Surface</b>				
59GP-D33-SS0	\$ 6,801.00	D/F Three position starter, 63 1/2" x 110 1/2" x 37"H		445
<b>Painted Metal T-Strip and Accent</b>				
<b>36" Wide Work Surface</b>				
59TP-D31-SS0	\$ 4,018.00	D/F One position starter, 63 1/2" x 37 1/2" x 37"H		155
<b>48" Wide Work Surface</b>				
59TP-D41-SS0	\$ 4,257.00	D/F One position starter, 63 1/2" x 49 1/4" x 37"H		195
<b>36" Wide Work Surface</b>				
59TP-D32-SS0	\$ 5,341.00	D/F Two position starter, 63 1/2" x 74" x 37"H		330
<b>48" Wide Work Surface</b>				
59TP-D42-SS0	\$ 5,512.00	D/F Two position starter, 63 1/2" x 97 1/4" x 37"H		355
<b>36" Wide Work Surface</b>				
59TP-D33-SS0	\$ 5,781.00	D/F Three position starter, 63 1/2" x 110 1/2" x 37"H		445
<b>Double Faced Adder Units (no styling)</b>				
<b>36" Wide Work Surface</b>				
59-D31-SA0	\$ 3,389.00	D/F One position adder, 63 1/2" x 37 1/2" x 37"H		155
<b>48" Wide Work Surface</b>				
59-D41-SA0	\$ 3,264.00	D/F One position adder, 63 1/2" x 48" x 37"H		195
<b>36" Wide Work Surface</b>				
59-D32-SA0	\$ 5,020.00	D/F Two position adder, 63 1/2" x 73" x 37"H		270
<b>48" Wide Work Surface</b>				
59-D42-SA0	\$ 4,963.00	D/F Two position adder, 63 1/2" x 96" x 37"H		355
<b>36" Wide Work Surface</b>				
59-D33-SA0	\$ 7,532.00	D/F Three position adder, 63 1/2" x 109 1/4" x 37"H		385

Please specify Wood Finish, Plastic Laminate, Metal Color, and Glass (where applicable). Details can be found in the Product Options section at the front of this Price List.

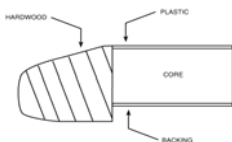

**Epoch Collection (prices shown in Maple wood)  
 Double Faced Modular LTS (Library Technology Stations)  
 2009 Brodart Furniture - List Prices**

Catalog Number	List Price	Description	Weight (lbs)
----------------	------------	-------------	--------------

**Glass Window and Chrome Accent**

**36" Wide Work Surface**

59GC-D31-SS0	\$ 5,483.00	D/F One position starter, 63 1/2" x 37 1/2" x 37"H	155
--------------	-------------	--	-----



**48" Wide Work Surface**

59GC-D41-SS0	\$ 5,810.00	D/F One position starter, 63 1/2" x 49 1/4" x 37"H	195
--------------	-------------	--	-----

**36" Wide Work Surface**

59GC-D32-SS0	\$ 7,289.00	D/F Two position starter, 63 1/2" x 74" x 37"H	330
--------------	-------------	--	-----

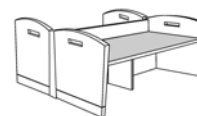

**48" Wide Work Surface**

59GC-D42-SS0	\$ 7,522.00	D/F Two position starter, 63 1/2" x 97 1/4" x 37"H	355
--------------	-------------	--	-----

**36" Wide Work Surface**

59GC-D33-SS0	\$ 7,889.00	D/F Three position starter, 63 1/2" x 110 1/2" x 37"H	445
--------------	-------------	---	-----



**Chrome T-Strip and Accent**

**36" Wide Work Surface**

59TC-D31-SS0	\$ 4,869.00	D/F One position starter, 63 1/2" x 37 1/2" x 37"H	155
--------------	-------------	--	-----

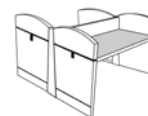

**48" Wide Work Surface**

59TC-D41-SS0	\$ 5,159.00	D/F One position starter, 63 1/2" x 49 1/4" x 37"H	195
--------------	-------------	--	-----

**36" Wide Work Surface**

59TC-D32-SS0	\$ 6,472.00	D/F Two position starter, 63 1/2" x 74" x 37"H	330
--------------	-------------	--	-----

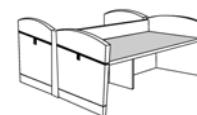

**48" Wide Work Surface**

59TC-D42-SS0	\$ 6,679.00	D/F Two position starter, 63 1/2" x 97 1/4" x 37"H	355
--------------	-------------	--	-----

**36" Wide Work Surface**

59TC-D33-SS0	\$ 7,005.00	D/F Three position starter, 63 1/2" x 110 1/2" x 37"H	445
--------------	-------------	---	-----



**Double Faced Adder Units (no styling)**

**36" Wide Work Surface**

59-D31-SA0	\$ 3,389.00	D/F One position adder, 63 1/2" x 37 1/2" x 37"H	155
------------	-------------	--	-----



**48" Wide Work Surface**

59-D41-SA0	\$ 3,264.00	D/F One position adder, 63 1/2" x 48" x 37"H	195
------------	-------------	--	-----

**36" Wide Work Surface**

59-D32-SA0	\$ 5,020.00	D/F Two position adder, 63 1/2" x 73" x 37"H	270
------------	-------------	--	-----

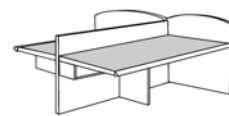

**48" Wide Work Surface**

59-D42-SA0	\$ 4,963.00	D/F Two position adder, 63 1/2" x 96" x 37"H	355
------------	-------------	--	-----

**36" Wide Work Surface**

59-D33-SA0	\$ 7,532.00	D/F Three position adder, 63 1/2" x 109 1/4" x 37"H	385
------------	-------------	---	-----

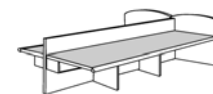

**Please specify Wood Finish, Plastic Laminate, Metal Color, and Glass (where applicable). Details can be found in the Product Options section at the front of this Price List.**

# Horizons Collection (prices shown in Maple wood)

## Computer Furniture

### 2009 Brodart Furniture - List Prices

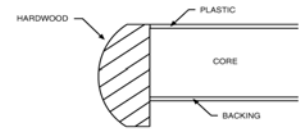

Catalog Number	List Price	Description	Weight (lbs)
----------------	------------	-------------	--------------

#### Single Faced Modular LTS (Library Technology Stations) w/ Cutouts

##### 36" Wide Work Surface

77-S31-SS0	\$ 2,150.00	S/F One position starter, 31" x 37 1/2" x 33 1/2"H
77-S31-SA0	\$ 1,601.00	S/F One position adder, 31" x 36 1/2" x 33 1/2"H



130



100

##### 48" Wide Work Surface

77-S41-SS0	\$ 2,283.00	S/F One position starter, 31" x 49 1/4" x 33 1/2"H
77-S41-SA0	\$ 1,702.00	S/F One position adder, 31" x 48" x 33 1/2"H

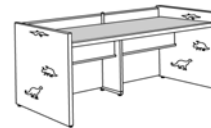

155

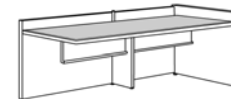

125

##### 36" Wide Work Surface

77-S32-SS0	\$ 2,892.00	S/F Two position starter, 31" x 74" x 33 1/2"H
77-S32-SA0	\$ 2,310.00	S/F Two position adder, 31" x 73" x 33 1/2"H

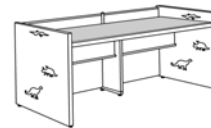

195

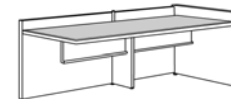

165

##### 48" Wide Work Surface

77-S42-SS0	\$ 3,112.00	S/F Two position starter, 31" x 97 1/4" x 33 1/2"H
77-S42-SA0	\$ 2,518.00	S/F Two position adder, 31" x 96" x 33 1/2"H



235



205

##### 36" Wide Work Surface

77-S33-SS0	\$ 3,774.00	S/F Three position starter, 31" x 110 1/2" x 33 1/2"H
77-S33-SA0	\$ 3,039.00	S/F Three position adder, 31" x 109 1/4" x 33 1/2"H



260



230

##### 90 Degree Corner Unit

77-SCR-SS0	\$ 4,517.00	Functional corner starter, 31" x 62" x 33 1/2"H
------------	-------------	---

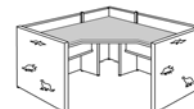

225

77-SCR-SA0	\$ 4,055.00	Functional corner adder, 31" x 62" x 33 1/2"H
------------	-------------	---

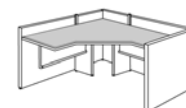

195

Please specify Wood Finish, Plastic Laminate, and Cut Outs. Details can be found in the Product Options section at the front of this Price List.

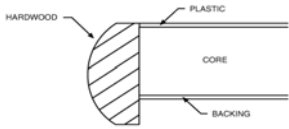

Catalog Number	List Price	Description	Weight (lbs)
----------------	------------	-------------	--------------

**Double Faced Modular LTS (Library Technology Stations) w/ Cutouts**

**36" Wide Work Surface**

77-D31-SS0	\$ 3,919.00	D/F One position starter, 59 1/2" x 37 1/2" x 33 1/2"H
77-D31-SA0	\$ 2,855.00	D/F One position adder, 59 1/2" x 36 1/2" x 33 1/2"H

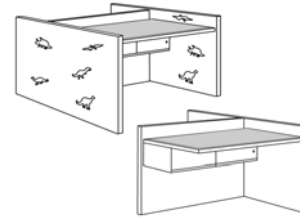

215  
155

**48" Wide Work Surface**

77-D41-SS0	\$ 4,153.00	D/F One position starter, 59 1/2" x 49 1/4" x 33 1/2"H
77-D41-SA0	\$ 3,070.00	D/F One position adder, 59 1/2" x 48" x 33 1/2"H

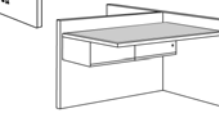

255  
195

**36" Wide Work Surface**

77-D32-SS0	\$ 5,217.00	D/F Two position starter, 59 1/2" x 74" x 33 1/2"H
77-D32-SA0	\$ 4,179.00	D/F Two position adder, 59 1/2" x 73" x 33 1/2"H

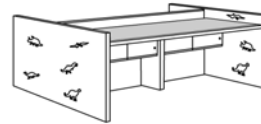

330  
270

**48" Wide Work Surface**

77-D42-SS0	\$ 5,598.00	D/F Two position starter, 59 1/2" x 97 1/4" x 33 1/2"H
77-D42-SA0	\$ 4,555.00	D/F Two position adder, 59 1/2" x 96" x 33 1/2"H

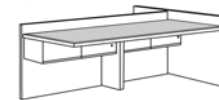

410  
155

**36" Wide Work Surface**

77-D33-SS0	\$ 6,822.00	D/F Three position starter, 59 1/2" x 110 1/2" x 33 1/2"H
77-D33-SA0	\$ 5,731.00	D/F Three position adder, 59 1/2" x 109 1/4" x 33 1/2"H

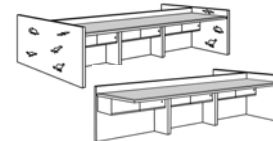

445  
385

**Please specify Wood Finish, Plastic Laminate, and Cut Outs. Details can be found in the Product Options section at the front of this Price List.**

**Libris Collection (prices shown in Oak wood)**

**Computer Furniture, Wood Legs  
2009 Brodart Furniture - List Prices**

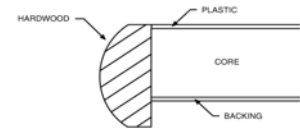

Catalog Number	List Price	Description	Weight (lbs)
----------------	------------	-------------	--------------

**Information Access Tables w/o Superstructure, Wood Legs**

**Sitting Height**

4W-645-S00	\$ 1,173.00	One Position, 24" x 30" x 27 1/2"H	80
4W-665-S00	\$ 1,254.00	One Position, 30" x 30" x 27 1/2"H	80
4W-649-S00	\$ 1,429.00	Two Position, 24" x 60" x 27 1/2"H	110
4W-669-S00	\$ 1,545.00	Two Position, 30" x 60" x 27 1/2"H	110



**Standing Height**

4W-665-S05	\$ 1,370.00	One Position, 30" x 30" x 39"H	85
4W-669-S05	\$ 1,641.00	Two Position, 30" x 60" x 39"H	112

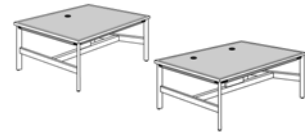

**Information Access Tables w/10"H Back Panel, Wood Legs**

**Sitting Height**

4W-643-S00	\$ 1,289.00	One Position, 24" x 36" x 27 1/2"H	99
4W-663-S00	\$ 1,405.00	One Position, 36" x 36" x 27 1/2"H	99
4W-642-S00	\$ 1,757.00	Two Position, 24" x 72" x 27 1/2"H	150
4W-662-S00	\$ 1,873.00	Two Position, 36" x 72" x 27 1/2"H	150
4W-644-S00	\$ 2,337.00	Three Position, 24" x 90" x 27 1/2"H	180
4W-664-S00	\$ 2,511.00	Three Position, 36" x 90" x 27 1/2"H	180

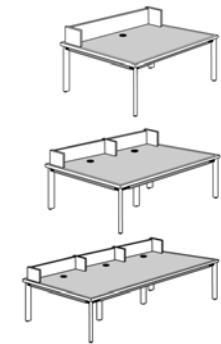

**Standing Height**

4W-663-S05	\$ 1,405.00	One Position, 36" x 36" x 39"H	102
4W-662-S05	\$ 1,873.00	Two Position, 36" x 72" x 39"H	150
4W-664-S05	\$ 2,511.00	Three Position, 36" x 90" x 39"H	180

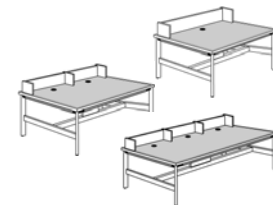

**Metal Accent Strips for Information Access Tables, Optional**

M91-AK-S00	\$ -	30" Square Table	5
M45-AK-S00	\$ -	24" x 30" Table	5
M43-AK-S00	\$ -	24" x 36" Table	5
M42-AK-S00	\$ -	24" x 72" Table	5
M644-AK-S00	\$ -	24" x 90" Table	6
M67-AK-S00	\$ -	30 X 48 Table	5
M69-AK-S00	\$ -	30 X 60 Table	5
M63-AK-S00	\$ -	36 x 36 Table	8
M38-AK-S00	\$ -	36 X 72 Table	8
M46-AK-S00	\$ -	36 X 90 Table	10

**Continuum 64 series furniture is available at 5% additional charge to 4W series prices**

**Please specify Wood Finish and Plastic Laminate. Details can be found in the Product Options section at the front of this Price List.**

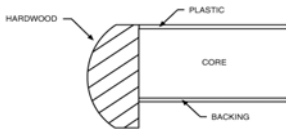

**Libris Collection (prices shown in Oak wood)  
Computer Furniture, Metal Legs  
2009 Brodart Furniture - List Prices**

Catalog Number	List Price	Description	Weight (lbs)
----------------	------------	-------------	--------------

**Information Access Tables, w/o superstructure, Metal Legs**

**Sitting Height**

4M-645-S00	\$ 1,246.00	One Position, 24" x 30" x 27 1/2"H
4M-665-S00	\$ 1,327.00	One Position, 30" x 30" x 27 1/2"H
4M-649-S00	\$ 1,501.00	Two Position, 24" x 60" x 27 1/2"H
4M-669-S00	\$ 1,616.00	Two Position, 30" x 60" x 27 1/2"H



80  
80  
110  
110

**Standing Height**

4M-665-S05	\$ 1,420.00	One Position, 30" x 30" x 39"H
4M-669-S05	\$ 1,646.00	Two Position, 30" x 60" x 39"H



85  
112

**Information Access Tables w/10"H Back Panel, Metal Legs**

**Sitting Height**

4M-643-S00	\$ 1,511.00	One Position, 24" x 36" x 27 1/2"H
4M-663-S00	\$ 1,592.00	One Position, 36" x 36" x 27 1/2"H
4M-642-S00	\$ 2,007.00	Two Position, 24" x 72" x 27 1/2"H
4M-662-S00	\$ 2,123.00	Two Position, 36" x 72" x 27 1/2"H
4M-644-S00	\$ 2,673.00	Three Position, 24" x 90" x 27 1/2"H
4M-664-S00	\$ 2,846.00	Three Position, 36" x 90" x 27 1/2"H

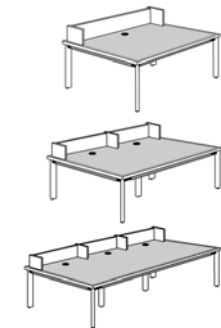

99  
99  
150  
150  
180  
180

**Standing Height**

4M-663-S05	\$ 1,592.00	One Position, 36" x 36" x 39"H
4M-662-S05	\$ 2,123.00	Two Position, 36" x 72" x 39"H
4M-664-S05	\$ 2,846.00	Three Position, 36" x 90" x 39"H

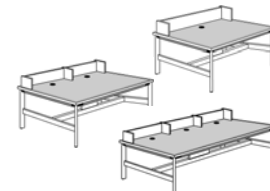

102  
150  
180

**Metal Accent Strips for Information Access Tables, Optional**

M91-AK-S00	\$ -	30" Square Table	5
M45-AK-S00	\$ -	24" x 30" Table	5
M43-AK-S00	\$ -	24" x 36" Table	5
M42-AK-S00	\$ -	24" x 72" Table	5
M644-AK-S00	\$ -	24" x 90" Table	6
M67-AK-S00	\$ -	30 X 48 Table	5
M69-AK-S00	\$ -	30 X 60 Table	5
M63-AK-S00	\$ -	36 x 36 Table	8
M38-AK-S00	\$ -	36 X 72 Table	8
M46-AK-S00	\$ -	36 X 90 Table	10

**Continuum 64 series furniture is available at 5% additional charge to 4W series prices**

**Please specify Wood Finish, Plastic Laminate, and Metal Color. Details can be found in the Product Options section at the front of this Price List.**

**Libris Collection (prices shown in Oak wood)**

**Computer Furniture, Wood Posts  
2009 Brodart Furniture - List Prices**

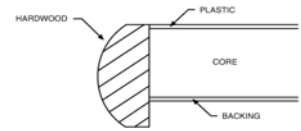

Catalog Number      List Price      Description Weight (lbs)

**Single Faced Information Access Carrels/Workstations w/Wood Posts**

**36" Wide Work Surface**

4W-673-S00      \$    1,562.00      S/F Starter, 33" x 37 3/4" x 47 3/4"H  
 4W-672-S00      \$    1,201.00      S/F Adder, 33" x 33 3/4" x 47 3/4"H

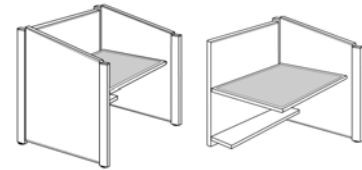

140  
110

**48" Wide Work Surface**

4W-460-S00      \$    1,832.00      S/F Starter, 33" x 49 1/2" x 47 3/4"H  
 4W-459-S00      \$    1,422.00      S/F Adder, 33" x 48 1/2" x 47 3/4"H

165  
135

**Double Faced Information Access Carrels/Workstations w/Wood Posts**

**36" Wide Work Surface**

4W-674-S00      \$    2,714.00      D/F Starter, 63 3/4" x 37 3/4" x 47 3/4"H  
 4W-675-S00      \$    2,027.00      D/F Adder, 63 3/4" x 33 3/4" x 47 3/4"H

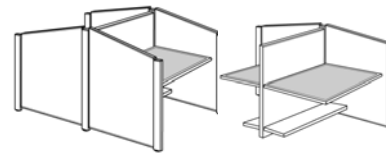

250  
185

**48" Wide Work Surface**

4W-461-S00      \$    3,027.00      D/F Starter, 63 3/4" x 49 1/2" x 47 3/4"H  
 4W-462-S00      \$    2,418.00      D/F Adder, 63 3/4" x 48 1/2" x 47 3/4"H

285  
220

**Pinwheel Design Information Access Carrels/Workstations w/Wood Posts**

**36" Wide Work Surface**

4W-676-S00      \$    4,820.00      Pinwheel, 69" x 69" x 47 3/4"H

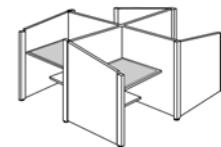

440

**48" Wide Work Surface**

4W-463-S00      \$    5,500.00      Pinwheel, 80" x 80" x 47 3/4"H

540

**Public Access Computer Stations, w/Wood Posts**

4W-685-S00      \$    4,767.00      Three Position Access Station, 47 1/2" x 99" x 48" H

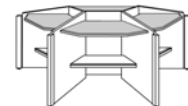

265

4W-682-S00      \$    9,764.00      Six Position Access Station, 99" x 99" x 48" H

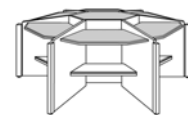

500

64-694-S00      \$    428.00      Movable Printer Shelf for PAC Stations



10

**Please specify Wood Finish and Plastic Laminate. Details can be found in the Product Options section at the front of this Price List.**



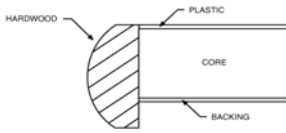

**Libris Collection (prices shown in Oak wood)  
Computer Furniture, Metal Posts  
2009 Brodart Furniture - List Prices**

Catalog Number	List Price	Description	Weight (lbs)
----------------	------------	-------------	--------------

**Single Faced Information Access Carrels/Workstations w/Metal Posts**

**36" Wide Work Surface**

4M-673-S00	\$ 1,764.00	S/F Starter, 33" x 37 3/4" x 47 3/4"H	140
4M-672-S00	\$ 1,354.00	S/F Adder, 33" x 33 3/4" x 47 3/4"H	110

**48" Wide Work Surface**

4M-460-S00	\$ 2,034.00	S/F Starter, 33" x 49 1/2" x 47 3/4"H	165
4M-459-S00	\$ 1,577.00	S/F Adder, 33" x 48 1/2" x 47 3/4"H	135

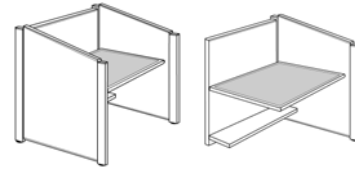

**Double Faced Information Access Carrels/Workstations w/Metal Posts**

**36" Wide Work Surface**

4M-674-S00	\$ 3,060.00	D/F Starter, 63 3/4" x 37 3/4" x 47 3/4"H	250
4M-675-S00	\$ 2,293.00	D/F Adder, 63 3/4" x 33 3/4" x 47 3/4"H	185

**48" Wide Work Surface**

4M-461-S00	\$ 3,360.00	D/F Starter, 63 3/4" x 49 1/2" x 47 3/4"H	285
4M-462-S00	\$ 2,684.00	D/F Adder, 63 3/4" x 48 1/2" x 47 3/4"H	220

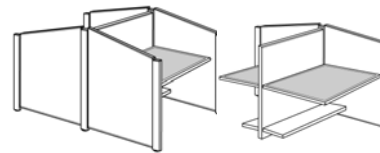

**Pinwheel Design Information Access Carrels/Workstations w/Metal Posts**

**36" Wide Work Surface**

4M-676-S00	\$ 5,345.00	Pinwheel, 69" x 69" x 47 3/4"H	440
------------	-------------	--------------------------------	-----

**48" Wide Work Surface**

4M-463-S00	\$ 6,094.00	Pinwheel, 80" x 80" x 47 3/4"H	540
------------	-------------	--------------------------------	-----

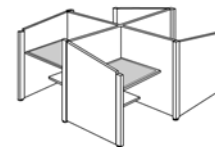

**Public Access Computer Stations, w/Metal Posts**

4M-685-S00	\$ 5,706.00	Three Position Access Station, 47 1/2" x 99" x 48" H	265
------------	-------------	--	-----

4M-682-S00	\$ 10,664.00	Six Position Access Station, 99" x 99" x 48" H	500
------------	--------------	--	-----

64-694-S00	\$ 428.00	Movable Printer Shelf for PAC Stations	10
------------	-----------	--	----

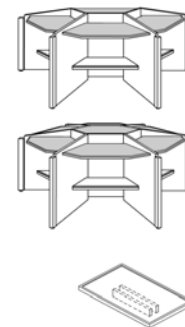

**Please specify Wood Finish, Plastic Laminate, and Metal Color. Details can be found in the Product Options section at the front of this Price List.**

**Matrix Collection (prices shown in Maple wood)**  
**Computer Furniture, Wood Legs**  
**2009 Brodart Furniture - List Prices**

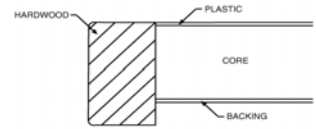

Catalog Number      List Price      Description Weight (lbs)

**Information Access Tables w/o Superstructure, Wood Legs**

**Sitting Height**

93-645-S00	\$ 1,539.00	One Position, 24" x 30" x 27 1/2"H
93-665-S00	\$ 1,612.00	One Position, 30" x 30" x 27 1/2"H
93-649-S00	\$ 2,054.00	Two Position, 24" x 60" x 27 1/2"H
93-669-S00	\$ 2,177.00	Two Position, 30" x 60" x 27 1/2"H



**Info Access Tables w/10"H Back Panel, Wood Legs**

**Sitting Height**

93-643-S00	\$ 1,833.00	One Position, 24" x 36" x 27 1/2"H
93-663-S00	\$ 1,956.00	One Position, 36" x 36" x 27 1/2"H
93-642-S00	\$ 2,364.00	Two Position, 24" x 72" x 27 1/2"H
93-662-S00	\$ 2,487.00	Two Position, 36" x 72" x 27 1/2"H
93-644-S00	\$ 3,079.00	Three Position, 24" x 90" x 27 1/2"H
93-664-S00	\$ 3,201.00	Three Position, 36" x 90" x 27 1/2"H

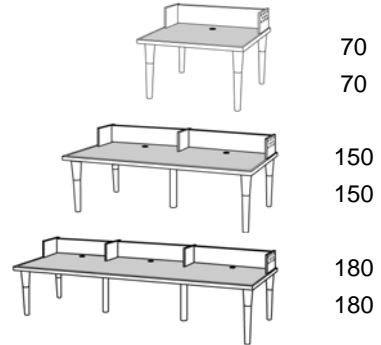

**Standing Height**

93-663-S05	\$ 2,008.00	One Position, 36" x 36" x 39"H
93-662-S05	\$ 2,548.00	Two Position, 36" x 72" x 39"H
93-664-S05	\$ 3,263.00	Three Position, 36" x 90" x 39"H

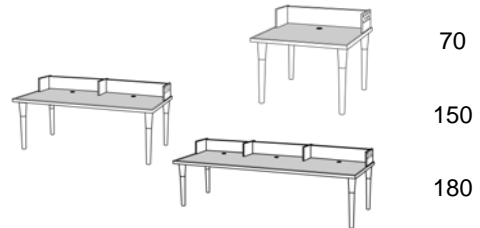

**Please specify Wood Finish and Plastic Laminate. Details can be found in the Product Options section at the front of this Price List.**

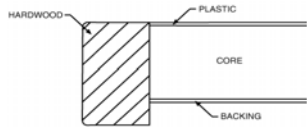

**Matrix Collection (prices shown in Maple wood)  
Computer Furniture  
2009 Brodart Furniture - List Prices**

Catalog Number	List Price	Description	Weight (lbs)
----------------	------------	-------------	--------------

**Information Access Tables w/o Superstructure, Metal Legs**

**Sitting Height**

93M-645-S00	\$ 1,596.00	One Position, 24" x 30" x 27 1/2"H
93M-665-S00	\$ 1,670.00	One Position, 30" x 30" x 27 1/2"H
93M-649-S00	\$ 2,112.00	Two Position, 24" x 60" x 27 1/2"H
93M-669-S00	\$ 2,235.00	Two Position, 30" x 60" x 27 1/2"H



**Info Access Tables w/10"H Back Panel, Metal Legs**

**Sitting Height**

93M-643-S00	\$ 1,891.00	One Position, 24" x 36" x 27 1/2"H
93M-663-S00	\$ 2,014.00	One Position, 36" x 36" x 27 1/2"H
93M-642-S00	\$ 2,422.00	Two Position, 24" x 72" x 27 1/2"H
93M-662-S00	\$ 2,544.00	Two Position, 36" x 72" x 27 1/2"H
93M-644-S00	\$ 3,136.00	Three Position, 24" x 90" x 27 1/2"H
93M-664-S00	\$ 3,259.00	Three Position, 36" x 90" x 27 1/2"H

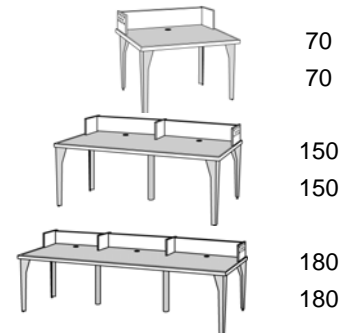

**Public Access Computer Station**

93-685-S00	\$ 6,698.00	Three Position Access Station, 47 1/2" x 99 1/2" x 42 1/4" H
93-682-S00	\$ 12,729.00	Six Position Access Station, 99 1/4" x 99 1/4" x 42 1/4" H

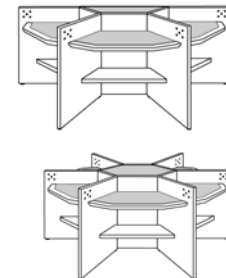

**OPAC Station**

93-039-S00	\$ 1,729.00	OPAC Station, 20" x 24 1/8" x 38 1/4"H
------------	-------------	--



**Please specify Wood Finish, Plastic Laminate, and Metal Color (if applicable). Details can be found in the Product Options section at the front of this Price List.**

# Matrix Collection (prices shown in Maple wood)

## Computer Furniture

### 2009 Brodart Furniture - List Prices

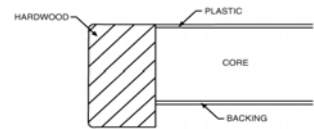

Catalog Number	List Price	Description	Weight (lbs)
----------------	------------	-------------	--------------

#### Single Faced Information Access Carrels/Workstations

##### 36" Wide Work Surface

93-673-S00	\$ 2,360.00	S/F Starter, 30 3/4" x 38 1/4" x 48 1/4"H	170
93-672-S00	\$ 1,949.00	S/F Adder, 30 3/4" x 37 1/4" x 48 1/4"H	120

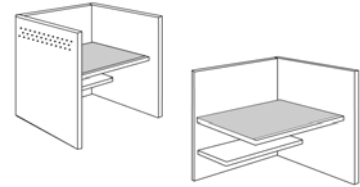

##### 48" Wide Work Surface

93-460-S00	\$ 2,530.00	S/F Starter, 30 3/4" x 50" x 48 1/4"H	200
93-459-S00	\$ 2,095.00	S/F Adder, 30 3/4" x 48 3/4" x 48 1/4"H	150

#### Single Faced Modular LTS (Library Technology Stations)

##### 36" Wide Work Surface

93-S31-SS0	\$ 1,967.00	S/F One position starter, 31" x 37 1/2" x 33 1/2"H	130
93-S31-SA0	\$ 1,603.00	S/F One position adder, 31" x 36 1/2" x 33 1/2"H	100

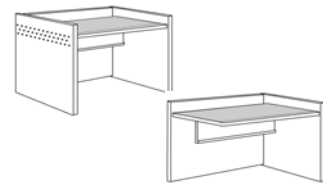

##### 48" Wide Work Surface

93-S41-SS0	\$ 2,101.00	S/F One position starter, 31" x 49 1/4" x 33 1/2"H	155
93-S41-SA0	\$ 1,703.00	S/F One position adder, 31" x 48" x 33 1/2"H	125

##### 36" Wide Work Surface

93-S32-SS0	\$ 2,710.00	S/F Two position starter, 31" x 74" x 33 1/2"H	195
93-S32-SA0	\$ 2,312.00	S/F Two position adder, 31" x 73" x 33 1/2"H	165

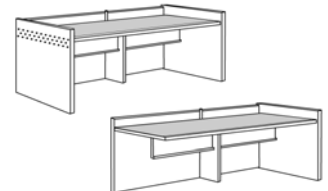

##### 48" Wide Work Surface

93-S42-SS0	\$ 2,930.00	S/F Two position starter, 31" x 97 1/4" x 33 1/2"H	235
93-S42-SA0	\$ 2,520.00	S/F Two position adder, 31" x 96" x 33 1/2"H	205

##### 36" Wide Work Surface

93-S33-SS0	\$ 3,593.00	S/F Three position starter, 31" x 110 1/2" x 33 1/2"H	260
93-S33-SA0	\$ 3,042.00	S/F Three position adder, 31" x 109 1/4" x 33 1/2"H	230

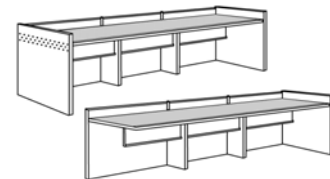

##### 90 Degree Corner Unit

93-SCR-SS0	\$ 4,336.00	Functional corner starter, 31" x 62" x 33 1/2"H	225
------------	-------------	---	-----

93-SCR-SA0	\$ 4,059.00	Functional corner adder, 31" x 62" x 33 1/2"H	195
------------	-------------	---	-----

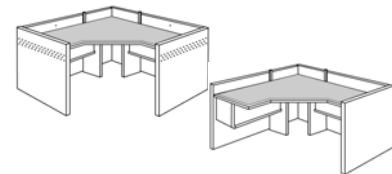

Please specify Wood Finish and Plastic Laminate. Details can be found in the Product Options section at the front of this Price List.

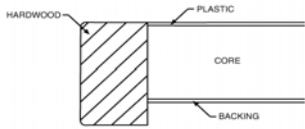

**Matrix Collection (prices shown in Maple wood)  
Computer Furniture  
2009 Brodart Furniture - List Prices**

Catalog Number	List Price	Description	Weight (lbs)
----------------	------------	-------------	--------------

**Double Faced Information Access Carrels/Workstations**

**36" Wide Work Surface**

93-674-S00	\$ 4,261.00	D/F Starter, 59 1/2" x 38 1/4" x 48 1/4"H
93-675-S00	\$ 3,489.00	D/F Adder, 59 1/2" x 37 1/4" x 48 1/4"H

**48" Wide Work Surface**

93-461-S00	\$ 4,628.00	D/F Starter, 59 1/2" x 50" x 48 1/4"H
93-462-S00	\$ 3,781.00	D/F Adder, 59 1/2" x 48 3/4" x 48 1/4"H

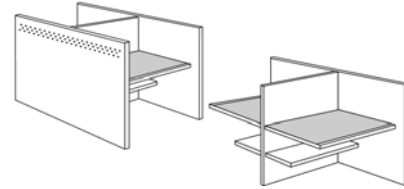

320  
220  
380  
280

**Double Faced Modular LTS (Library Technology Stations)**

**36" Wide Work Surface**

93-D31-SS0	\$ 3,554.00	D/F One position starter, 59 1/2" x 37 1/2" x 33 1/2"H
93-D31-SA0	\$ 2,858.00	D/F One position adder, 59 1/2" x 36 1/2" x 33 1/2"H

**48" Wide Work Surface**

93-D41-SS0	\$ 3,788.00	D/F One position starter, 59 1/2" x 49 1/4" x 33 1/2"H
93-D41-SA0	\$ 3,072.00	D/F One position adder, 59 1/2" x 48" x 33 1/2"H

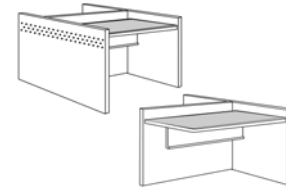

215  
155  
255  
195

**36" Wide Work Surface**

93-D32-SS0	\$ 4,853.00	D/F Two position starter, 59 1/2" x 74" x 33 1/2"H
93-D32-SA0	\$ 4,183.00	D/F Two position adder, 59 1/2" x 73" x 33 1/2"H

**48" Wide Work Surface**

93-D42-SS0	\$ 5,234.00	D/F Two position starter, 59 1/2" x 97 1/4" x 33 1/2"H
93-D42-SA0	\$ 4,558.00	D/F Two position adder, 59 1/2" x 96" x 33 1/2"H

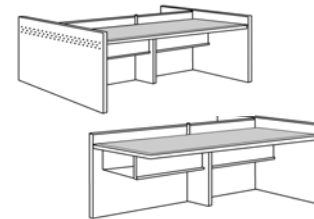

330  
270  
410  
155

**36" Wide Work Surface**

93-D33-SS0	\$ 6,459.00	D/F Three position starter, 59 1/2" x 110 1/2" x 33 1/2"H
93-D33-SA0	\$ 5,736.00	D/F Three position adder, 59 1/2" x 109 1/4" x 33 1/2"H



445  
385

**Please specify Wood Finish and Plastic Laminate. Details can be found in the Product Options section at the front of this Price List.**

# M-Table (prices shown in Oak wood)

## Computer Furniture

### 2009 Brodart Furniture - List Prices

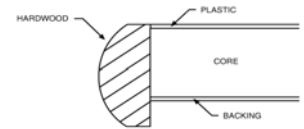

Catalog Number	List Price	Description	Weight (lbs)
----------------	------------	-------------	--------------

#### Info Access Tables w/o Superstructure

##### Sitting Height

MT-645-S00	\$ 1,204.00	One Position, 24" x 30" x 27 1/2"H
MT-665-S00	\$ 1,278.00	One Position, 30" x 30" x 27 1/2"H
MT-649-S00	\$ 1,721.00	Two Position, 24" x 60" x 27 1/2"H
MT-669-S00	\$ 1,844.00	Two Position, 30" x 60" x 27 1/2"H



80

80

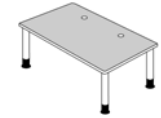

110

110

##### Standing Height

MT-665-S05	\$ 1,284.00	One Position, 30" x 30" x 39"H
MT-669-S05	\$ 1,850.00	Two Position, 30" x 60" x 39"H



85



115

#### Info Access Tables w/10"H Back Panel

##### Sitting Height

MT-643-S00	\$ 1,499.00	One Position, 24" x 36" x 27 1/2"H
MT-663-S00	\$ 1,622.00	One Position, 36" x 36" x 27 1/2"H
MT-642-S00	\$ 2,016.00	Two Position, 24" x 72" x 27 1/2"H
MT-662-S00	\$ 2,138.00	Two Position, 36" x 72" x 27 1/2"H
MT-644-S00	\$ 2,747.00	Three Position, 24" x 90" x 27 1/2"H
MT-664-S00	\$ 2,870.00	Three Position, 36" x 90" x 27 1/2"H

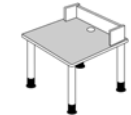

70

70

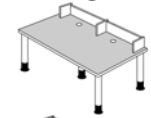

150

150

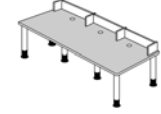

180

180

##### Standing Height

MT-663-S05	\$ 1,628.00	One Position, 36" x 36" x 39"H
MT-662-S05	\$ 2,151.00	Two Position, 36" x 72" x 39"H
MT-664-S05	\$ 2,882.00	Three Position, 36" x 90" x 39"H



70

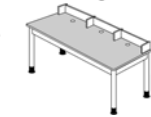

150

180

Please specify Wood Finish, Plastic Laminate, and Metal Color (if applicable). Details can be found in the Product Options section at the front of this Price List.



# Quorum 94T Series (prices shown in Oak wood)

## Computer Furniture

### 2009 Brodart Furniture - List Prices

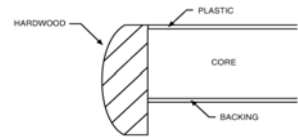

Catalog Number	List Price	Description		Weight (lbs)
<b>Info Access Tables w/o Superstructure</b>				
<b>Sitting Height</b>				
94T-645-S00	\$ 1,044.00	One Position, 24" x 30" x 27 1/2"H		80
94T-665-S00	\$ 1,113.00	One Position, 30" x 30" x 27 1/2"H		80
94T-669-S00	\$ 1,614.00	Two Position, 30" x 60" x 27 1/2"H		110
94T-649-S00	\$ 1,498.00	Two Position, 24" x 60" x 27 1/2"H		110
<b>Standing Height</b>				
94T-665-S05	\$ 1,113.00	One Position, 30" x 30" x 39"H		85
94T-669-S05	\$ 1,614.00	Two Position, 30" x 60" x 39"H		115
<b>Info Access Tables w/10"H Back Panel</b>				
<b>Sitting Height</b>				
94T-643-S00	\$ 1,289.00	One Position, 24" x 36" x 27 1/2"H		70
94T-663-S00	\$ 1,405.00	One Position, 36" x 36" x 27 1/2"H		80
94T-663-S02	\$ 1,562.00	One Position w/ Storage Shelf, 36" x 36" x 27 1/2"H		90
94T-642-S00	\$ 1,757.00	Two Position, 24" x 72" x 27 1/2"H		150
94T-662-S00	\$ 1,873.00	Two Position, 36" x 72" x 27 1/2"H		150
94T-662-S02	\$ 2,118.00	Two Position w/ Storage Shelf, 36" x 72" x 27 1/2"H		160
94T-644-S00	\$ 2,395.00	Three Position, 24" x 90" x 27 1/2"H		180
94T-664-S00	\$ 2,511.00	Three Position, 36" x 90" x 27 1/2"H		170
94T-664-S02	\$ 2,864.00	Three Position w/ Storage Shelf, 36" x 90" x 27 1/2"H		190
<b>Standing Height</b>				
94T-663-S05	\$ 1,405.00	One Position, 36" x 36" x 39"H		85
94T-663-S06	\$ 1,562.00	One Position w/ Storage Shelf, 36" x 36" x 39"H		95
94T-662-S05	\$ 1,873.00	Two Position, 36" x 72" x 39"H		150
94T-662-S06	\$ 2,118.00	Two Position w/ Storage Shelf, 36" x 72" x 39"H		160
94T-664-S05	\$ 2,511.00	Three Position, 36" x 90" x 39"H		180
94T-664-S06	\$ 2,864.00	Three Position w/ Storage Shelf, 36" x 90" x 39"H		200

Please specify Wood Finish and Plastic Laminate. Details can be found in the Product Options section at the front of this Price List.



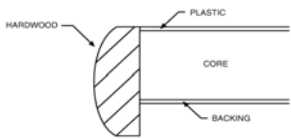

**Quorum 94T Series (prices shown in Oak wood)  
Computer Furniture  
2009 Brodart Furniture - List Prices**

Catalog Number	List Price	Description	Weight (lbs)
----------------	------------	-------------	--------------

**Single Faced Info Access Carrels/Workstations**

**36" Wide Work Surface**

94T-673-S00	\$ 1,767.00	S/F Starter, 33 1/2" x 38 1/2" x 47 3/4"H	85
94T-672-S00	\$ 1,521.00	S/F Adder, 33 1/2" x 37" x 47 3/4"H	75

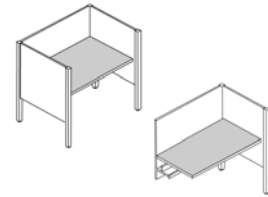

**48" Wide Work Surface**

94T-460-S00	\$ 1,899.00	S/F Starter, 33 1/2" x 50" x 47 3/4"H	90
94T-459-S00	\$ 1,638.00	S/F Adder, 33 1/2" x 48 1/2" x 47 3/4"H	80

**Double Faced Info Access Carrels/Workstations**

**36" Wide Work Surface**

94T-674-S00	\$ 3,256.00	D/F Starter, 65 1/4" x 38 1/2" x 47 3/4"H	140
94T-675-S00	\$ 2,706.00	D/F Adder, 65 1/4" x 37 1/4" x 47 3/4"H	126

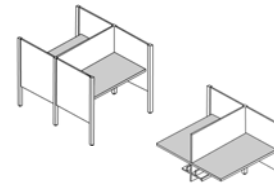

**48" Wide Work Surface**

94T-461-S00	\$ 3,540.00	D/F Starter, 65 1/4" x 50" x 47 3/4"H	150
94T-462-S00	\$ 2,936.00	D/F Adder, 65 1/4" x 48 1/2" x 47 3/4"H	136

**Pinwheel Design Info Access Carrels/Workstations**

**36" Wide Work Surface**

94T-676-S00	\$ 5,441.00	Pinwheel, 75 1/4" x 75 1/4" x 47 3/4"H	375
-------------	-------------	--	-----

**48" Wide Work Surface**

94T-463-S00	\$ 6,109.00	Pinwheel, 98 1/2" x 98 1/2" x 47 3/4"H	425
-------------	-------------	--	-----

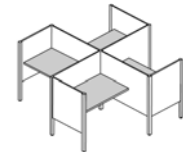

**Public Access Computer Stations**

94T-685-S00	\$ 5,212.00	Three Position Access Station, 47 1/2" x 99 1/2" x 42 1/4" H	401
-------------	-------------	--	-----

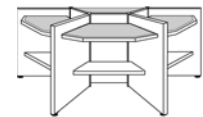

94T-688-S00	\$ 7,451.00	Four Position Access Station,	510
-------------	-------------	-------------------------------	-----

94T-682-S00	\$ 9,701.00	Six Position Access Station, 99 1/4" x 99 1/4" x 42 1/4" H	629
-------------	-------------	--	-----

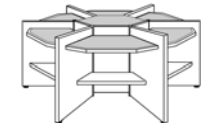

64-694-S00	\$ 428.00	Movable Printer Shelf for PAC Stations	10
------------	-----------	--	----



**OPAC Station**

94T-039-S00	\$ 1,435.00	OPAC Station, 20" x 24 1/8" x 39 1/4"H	110
-------------	-------------	--	-----



**Please specify Wood Finish and Plastic Laminate. Details can be found in the Product Options section at the front of this Price List.**

**Quorum 94T Series (prices shown in Oak wood)**

**Computer Furniture**

**2009 Brodart Furniture - List Prices**

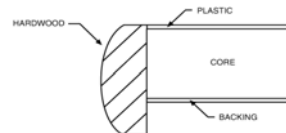

Catalog Number      List Price      Description Weight (lbs)

**Single Faced Modular LTS (Library Technology Stations)**

**36" Wide Work Surface**

94T-S31-SS0	\$ 1,440.00	S/F One position starter, 31" x 37 1/2" x 33 1/2"H		130
94T-S31-SA0	\$ 1,235.00	S/F One position adder, 31" x 36 1/2" x 33 1/2"H		100

**48" Wide Work Surface**

94T-S41-SS0	\$ 1,555.00	S/F One position starter, 31" x 49 1/4" x 33 1/2"H		155
94T-S41-SA0	\$ 1,318.00	S/F One position adder, 31" x 48" x 33 1/2"H		125

**36" Wide Work Surface**

94T-S32-SS0	\$ 2,058.00	S/F Two position starter, 31" x 74" x 33 1/2"H		195
94T-S32-SA0	\$ 1,826.00	S/F Two position adder, 31" x 73" x 33 1/2"H		165

**48" Wide Work Surface**

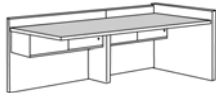
94T-S42-SS0	\$ 2,276.00	S/F Two position starter, 31" x 97 1/4" x 33 1/2"H		235
94T-S42-SA0	\$ 1,997.00	S/F Two position adder, 31" x 96" x 33 1/2"H		205

**36" Wide Work Surface**

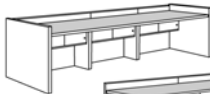
94T-S33-SS0	\$ 2,793.00	S/F Three position starter, 31" x 110 1/2" x 33 1/2"H		260
94T-S33-SA0	\$ 2,430.00	S/F Three position adder, 31" x 109 1/4" x 33 1/2"H		230

**90 Degree Corner Unit**

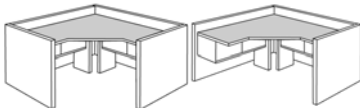
94T-SCR-SS0	\$ 3,411.00	Functional corner starter, 31" x 62" x 33 1/2"H		225
94T-SCR-SA0	\$ 3,277.00	Functional corner adder, 31" x 62" x 33 1/2"H		195

**Please specify Wood Finish and Plastic Laminate. Details can be found in the Product Options section at the front of this Price List.**

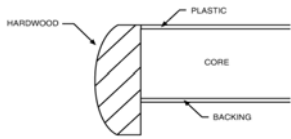

**Quorum 94T Series (prices shown in Oak wood)**

**Computer Furniture**

**2009 Brodart Furniture - List Prices**

Catalog Number	List Price	Description	Weight (lbs)
----------------	------------	-------------	--------------

**Double Faced Modular LTS (Library Technology Stations)**

**36" Wide Work Surface**

94T-D31-SS0	\$ 2,587.00	D/F One position starter, 59 1/2" x 37 1/2" x 33 1/2"H
94T-D31-SA0	\$ 2,193.00	D/F One position adder, 59 1/2" x 36 1/2" x 33 1/2"H

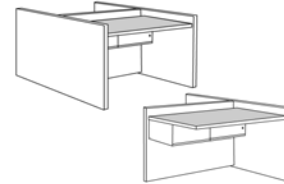

215  
155

**48" Wide Work Surface**

94T-D41-SS0	\$ 2,783.00	D/F One position starter, 59 1/2" x 49 1/4" x 33 1/2"H
94T-D41-SA0	\$ 2,370.00	D/F One position adder, 59 1/2" x 48" x 33 1/2"H

**36" Wide Work Surface**

94T-D32-SS0	\$ 3,667.00	D/F Two position starter, 59 1/2" x 74" x 33 1/2"H
94T-D32-SA0	\$ 3,294.00	D/F Two position adder, 59 1/2" x 73" x 33 1/2"H

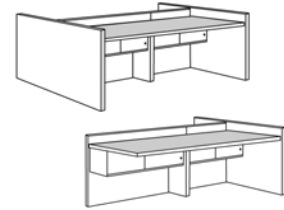

330  
270

**48" Wide Work Surface**

94T-D42-SS0	\$ 3,984.00	D/F Two position starter, 59 1/2" x 97 1/4" x 33 1/2"H
94T-D42-SA0	\$ 3,605.00	D/F Two position adder, 59 1/2" x 96" x 33 1/2"H

**36" Wide Work Surface**

94T-D33-SS0	\$ 5,002.00	D/F Three position starter, 59 1/2" x 110 1/2" x 33 1/2"H
94T-D33-SA0	\$ 4,585.00	D/F Three position adder, 59 1/2" x 109 1/4" x 33 1/2"H



445  
385

**Please specify Wood Finish and Plastic Laminate. Details can be found in the Product Options section at the front of this Price List.**

**Modifications & Charges**  
**Computer Furniture**  
**2009 Brodart Furniture - List Prices**

Catalog Number	List Price	Description	Weight (lbs)
----------------	------------	-------------	--------------

**Casters for Info Access Tables**

LG-CST-S00	\$ 76.00	Caster to Convert Table to be Mobile-Includes a Brake (Price is per Leg)	
------------	----------	--	--



\* Casters are Available for the M-Table series in the M-Table Section of this Price List

**Cut Down in Dimension of Info Access Tables w/o Superstructure**

\$ 157.00	1 Dimension Cut Down
\$ 223.00	2 Dimension Cut Down

**Cut Down in Dimension of Info Access Tables w/ Superstructure**

\$ 288.00	1 Dimension Cut Down
\$ 419.00	2 Dimension Cut Down

**Change Standard HPL to Marmoleum on Info Access Tables**

add	25%	Per Table
-----	-----	-----------

**Change Standard Top/Edge Band to Corian**

Please Call for Pricing

**Continuum 64 series furniture is available at 5% additional charge to 4W series prices**

**Modifications & Charges**  
**Computer Furniture**  
**2009 Brodart Furniture - List Prices**

<u>Catalog Number</u>	<u>List Price</u>	<u>Description</u>	<u>Weight (lbs)</u>
-----------------------	-------------------	--------------------	---------------------

---

**Cut Down in Dimension of any LTS/Carrel Unit**

\$ 314.00 Per Dimension, Per Unit

**Add an ADA Station to any LTS/Carrel Unit**

\$ 248.00 Per Unit - Must Specify Location of Unit

**Change Standard HPL to Marmoleum on Info Access Tables**

add 18% Per Table

**Change Standard Top/Edge Band to Corian**

Please Call for Pricing

**Electrical**  
**Circulation Desks & Computer Furniture**  
**2009 Brodart Furniture - List Prices**

Catalog Number	List Price	Description	Weight (lbs)
<b>UL Listed Electric for Circulation Desks</b>			
X3-100-S00	\$ 340.00	Power Entries, All Series, Cord and Plug (Single Circuit)	
X3-100-S02	\$ 404.00	Power Entries, All Series, Hardwired (Multiple Circuit)	
<b>Power Distribution Channels, Circulation Desk, All Series</b>			
X3-012-S02	\$ 421.00	One Duplex Receptacle, All single wide units (except _044)	
X3-012-S00	\$ 500.00	Two Duplex Receptacle, All single wide units (except _044)	
X3-044-S02	\$ 448.00	One Duplex Receptacle, Recessed monitor desk _044	
X3-044-S00	\$ 531.00	Two Duplex Receptacle, Recessed monitor desk _044	
X3-011-S00	\$ 527.00	Two Duplex Receptacles, All double wide units	
X3-017-S02	\$ 716.00	One Duplex Receptacle, Multipurpose Corner Desk	
X3-017-S00	\$ 785.00	Two Duplex Receptacle, Multipurpose Corner Desk	
X3-052-S02	\$ 531.00	One Duplex Receptacle, 45 degree Curved Corner	
X3-052-S00	\$ 516.00	Two Duplex Receptacle, 45 degree Curved Corner	
X3-050-S02	\$ 537.00	One Duplex Receptacle, 60 degree Curved Corner	
X3-050-S00	\$ 583.00	Two Duplex Receptacle, 60 degree Curved Corner	
X3-040-S02	\$ 496.00	One Duplex Receptacle, 90 degree Curved Corner	
X3-040-S00	\$ 527.00	Two Duplex Receptacle, 90 degree Curved Corner	
X3-047-S00	\$ 597.00	Two Duplex Receptacle, 60 degree Nu-Curved Desk	
<b>Power Distribution Channel for ADA units</b>			
X3-032-S00	\$ 542.00	Two Duplex Outlet	
X3-032-S02	\$ 524.00	One Duplex Outlet	
<b>Bypass Power Distribution, Circulation Desks</b>			
X3-312-S00	\$ 387.00	All Single Wide Units (except _044)	
X3-344-S00	\$ 420.00	Recessed Monitor Desk _044	
X3-311-S00	\$ 497.00	All Double Wide Units	
X3-317-S00	\$ 499.00	Multipurpose Corner Desk	
X3-316-S00	\$ 382.00	90 degree Closed Corner	
X3-352-S00	\$ 404.00	45 degree Curved Corner	
X3-350-S00	\$ 411.00	60 degree Curved Corner	
X3-340-S00	\$ 502.00	90 degree Curved Corner	
X3-347-S00	\$ 496.00	60 degree Nu-Curved Desk	
<b>Duplex Outlet Receptacles</b>			
X3-001-S00	\$ 55.00	Circuit I	
X3-002-S00	\$ 55.00	Circuit II	
X3-003-S00	\$ 55.00	Circuit III	
X3-004-S00	\$ 55.00	Circuit IV	
<b>Data/Communication Terminal &amp; Jacks</b>			
X3-005-S00	\$ 32.00	RJ11 Telephone Jack	
X3-007-S00	\$ 35.00	RJ45 Category Five Data Jack	
X3-007-S02	\$ 55.00	RJ45 Category Five Data Jack w/9 ft Patch Cord	
X3-007-S03	\$ 59.00	RJ45 Category Five Data Jack w/12 ft Patch Cord	

**Electrical**  
**Circulation Desks & Computer Furniture**  
**2009 Brodart Furniture - List Prices**

Catalog Number	List Price	Description	Weight (lbs)
<b>UL Listed Electric for Modular Carrels/Computer Stations-Power Entries Carrels</b>			
X3-100-S00	\$ 340.00	Panel base, cord and plug (Single Circuit)	
X3-100-S02	\$ 404.00	Panel base, Hardwired (Multiple Circuit)	
X3-101-S00	\$ 340.00	Series 64 & 94, Cord and Plug (Single Circuit)	
X3-101-S02	\$ 404.00	Series 64 & 94, Hardwired (Multiple Circuit)	
<b>Power Distribution Channels, Carrels, All Series</b>			
X3-678-S02	\$ 417.00	One Duplex Receptacle, For Table 30"W	
X3-678-S00	\$ 486.00	Two Duplex Receptacles, For Table 30"W	
X3-673-S02	\$ 421.00	One Duplex Receptacle, For Table 36"W	
X3-673-S00	\$ 493.00	Two Duplex Receptacles, For Table 36"W	
X3-460-S02	\$ 434.00	One Duplex Receptacle, For Table 48"W	
X3-460-S00	\$ 516.00	Two Duplex Receptacles, For Table 48"W	
<b>UL Listed Electric for LTS Series</b>			
X3-300-S00	\$ 334.00	Power Entry - Cord and Plug - Single Circuit, Wood Chase	
X3-300-S02	\$ 397.00	Power Entry - Hardwired - Multiple Circuit, Wood Chase	
<b>Power Distribution Channel for LTS Series</b>			
X3-354-S00	\$ 302.00	One Duplex Receptacle, Single wide unit (36" Wide Position)	
X3-454-S00	\$ 327.00	One Duplex Receptacle, Single wide unit (48" Wide Position)	
X3-554-S00	\$ 462.00	One Duplex Receptacle, Single wide unit (Functional Corner Unit)	
<b>Table Top/Worksurface Distribution</b>			
73-560-S00	\$ 224.00	Corner Power Unit	
73-559-S00	\$ 378.00	Corner Power and Communication Center w/o Patch Cords	
73-559-S02	\$ 410.00	Corner Power and Communication Center w/9 ft Patch Cords	
73-253-001	\$ 217.00	New Style Light Black 24"W w/ 1 ft power cord	
73-253-002	\$ 217.00	New Style Light Black 24"W w/ 8 ft power cord	
73-253-011	\$ 237.00	New Style Light Black 36"W w/ 1 ft power cord	
73-253-012	\$ 237.00	New Style Light Black 36"W w/ 9 ft power cord	
<b>OPAC Station Power Assembly</b>			
73-274-S00	\$ 776.00	Panel Power Assembly for 3 and 6 Position Pac Station	

**Electrical  
For Tables  
2009 Brodart Furniture - List Prices**

Catalog Number	List Price	Description	Weight (lbs)
<b>Table Top/Worksurface Distribution</b>			
73-268-S00	\$ 496.00	Tilt up Power and Data Center	
73-368-S00	\$ 1,036.00	D/F Tilt Up Power and Data Assembly	
73-280-S00	\$ 511.00	Panel Table Power and Data Outlet	
<b>Wire Manager-For Table Mounting</b>			
X1-700-030	\$ 62.00	22" J-Channel	
X1-700-031	\$ 80.00	28" J-Channel	
<b>Berwyn Series Wire Management Leg</b>			
X3-665-S00	\$ 249.00	Leg & Plate Type-for 29"H Table	10
X3-665-S02	\$ 249.00	Leg & Plate Type-for 27-1/2"H Table	10
X3-665-S03	\$ 249.00	Leg & Plate Type-for 25"H Table	10
X3-665-S04	\$ 249.00	Leg & Plate Type-for 32"H Table	10
X3-666-S00	\$ 249.00	Leg & Apron Type-for 29"H Table	10
X3-666-S05	\$ 249.00	Leg & Apron Type-for 39"H Table	10
<b>Chancellor's Series Wire Management Leg</b>			
X3-CHR6-S00	\$ 249.00	Leg & Apron Type-for 29"H Table	10
X3-CHR6-S02	\$ 249.00	Leg & Apron Type-for 27-1/2"H Table	10
X3-CHR6-S04	\$ 249.00	Leg & Apron Type-for 32"H Table	10
X3-CHR6-S05	\$ 249.00	Leg & Apron Type-for 39"H Table	10
X3-CH25-S00	\$ 249.00	Leg & Plate Type-for 29"H Table	10
X3-CH25-S02	\$ 249.00	Leg & Plate Type-for 27-1/2"H Table	10
<b>Epoch Series Wire Management Leg</b>			
59-945-S00	\$ 287.00	Powder Coated Leg, 29"H	12
59-945-S02	\$ 288.00	Powder Coated Leg, 27 1/2"H	12
59-945-S03	\$ 287.00	Powder Coated Leg, 25"H	12
59C-945-S00	\$ 567.00	Chrome Leg, 29"H	12
59C-945-S02	\$ 557.00	Chrome Leg, 27 1/2"H	12
59C-945-S03	\$ 557.00	Chrome Leg, 25"H	12
59W-945-S00	\$ 336.00	Wood Leg, 29"H	8
59W-945-S02	\$ 336.00	Wood Leg, 27 1/2"H	8
59W-945-S03	\$ 336.00	Wood Leg, 25"H	8



**Electrical  
For Tables  
2009 Brodart Furniture - List Prices**

Catalog Number	List Price	Description	Weight (lbs)
<b>Libris Series Wire Management Leg</b>			
<b>Wood Leg</b>			
X3-4W5-S00	\$ 231.00	Leg & Plate Type-for 29"H Table	10
X3-4W5-S02	\$ 231.00	Leg & Plate Type-for 27-1/2"H Table	10
X3-4W5-S03	\$ 231.00	Leg & Plate Type-for 25"H Table	10
X3-4W5-S04	\$ 231.00	Leg & Plate Type-for 32"H Table	10
<b>Metal Leg</b>			
X3-4M5-S00	\$ 231.00	Leg & Plate Type-for 29"H Table	10
X3-4M5-S02	\$ 231.00	Leg & Plate Type-for 27-1/2"H Table	10
X3-4M5-S03	\$ 231.00	Leg & Plate Type-for 25"H Table	10
X3-4M5-S04	\$ 231.00	Leg & Plate Type-for 32"H Table	10
<b>Quorum 94T Series Wire Management Leg</b>			
X3-945-S00	\$ 231.00	Leg & Plate Type-for 29"H Table	10
X3-945-S02	\$ 231.00	Leg & Plate Type-for 27-1/2"H Table	10
X3-945-S03	\$ 231.00	Leg & Plate Type-for 25"H Table	10
X3-945-S04	\$ 231.00	Leg & Plate Type-for 32"H Table	10
X3-946-S00	\$ 231.00	Leg & Apron Type-for 29"H Table	10
X3-946-S04	\$ 231.00	Leg & Apron Type-for 32"H Table	10
X3-946-S05	\$ 231.00	Leg & Apron Type-for 39"H Table	10
<b>Flexible Wire Management Channels (leg style)</b>			
73-210-S00	\$ 285.00	Flexible wire management channel, 32" for sitting height tables	
73-210-S01	\$ 314.00	Flexible wire management channel, 39" for standing height tables	

**Electrical  
Accessories  
2009 Brodart Furniture - List Prices**

Catalog Number	List Price	Description	Weight (lbs)
<b>Grommets</b>			
X1-700-001	\$ 54.00	Grommet w/Cap-2" Round *	
X1-700-002	\$ 62.00	Grommet w/Cap-3-1/2" Round *	
X1-700-111	\$ 131.00	Grommet w/Paper Slot-17" Long *	
		* Field Installed unless specified with order	
<b>Accessories</b>			
X1-700-112	\$ 86.00	Power Strip-3 Outlets	
73-200-S00	\$ 328.00	Electrical Interport w/2 outlets & 2 ports for data (purchase data separately)	
73-258-S00	\$ 265.00	Power/Data Strip-4 Outlets and 2 Data jacks	
<b>Wire Managers</b>			
X1-700-020	\$ 76.00	Plastic J-Channel Wire Manager	
X1-700-065	\$ 92.00	Data and Communication Raceway 1/2"H x 1"W x 6'L	
X1-700-066	\$ 142.00	Power Data Raceway 7/8"H x 1-1/2"W x 10'L	
X1-700-074	\$ 56.00	Horizontal Surface Mount Data Outlet Box w/o Data Jacks & Cables	
X1-700-070	\$ 85.00	Vertical Data Outlet Box	
X1-700-050	\$ 220.00	Vertical Wire Manager	
<b>Wire Managers-For Panel Mounting</b>			
XJ-695-S00	\$ 106.00	22" J-Channel	
XJ-678-S00	\$ 117.00	26" J-Channel	
XJ-012-S00	\$ 125.00	30" J-Channel	
XJ-673-S00	\$ 125.00	32" J-Channel	
XJ-047-S00	\$ 142.00	38" J-Channel	
XJ-460-S00	\$ 151.00	44" J-Channel	
<b>Vertical Chase</b>			
X1-700-195	\$ 142.00	Wood wire chase for 25"H W/S - Actual height 22"	
X1-700-197	\$ 178.00	Wood wire chase for 29"H W/S - Actual height 26"	
X1-700-199	\$ 194.00	Wood wire chase for 39"H W/S - Actual height 36"	











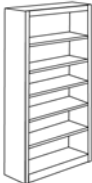

# Wood Shelving

Single Faced Shelving (prices shown in Oak wood\*)

2009 Brodart Furniture - List Prices

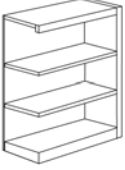

Catalog Number	List Price	Description			Weight (lbs)
<b>90"H - 6 adjustable shelves, 1 base shelf</b>					
S1-960-S00	\$ 1,309.00	S/F Starter, 10"D x 90"H			103
S2-960-S00	\$ 995.00	S/F Adder, 10"D x 90"H			90
S1-967-S00	\$ 1,412.00	S/F Starter, 12"D x 90"H			122
S2-967-S00	\$ 1,074.00	S/F Adder, 12"D x 90"H			102
<b>82"H - 5 adjustable shelves, 1 base shelf</b>					
S1-976-S00	\$ 1,194.00	S/F Starter, 10"D x 82"H			93
S2-976-S00	\$ 905.00	S/F Adder, 10"D x 82"H			80
S1-977-S00	\$ 1,290.00	S/F Starter, 12"D x 82"H			112
S2-977-S00	\$ 978.00	S/F Adder, 12"D x 82"H			92
S1-679-S00	\$ 1,434.00	S/F Starter, 16"D x 82"H			103
S2-679-S00	\$ 1,122.00	S/F Adder, 16"D x 82"H			80
<b>72"H - 4 adjustable shelves, 1 base shelf</b>					
S1-861-S00	\$ 1,087.00	S/F Starter, 10"D x 72"H			88
S2-861-S00	\$ 823.00	S/F Adder, 10"D x 72"H			75
S1-863-S00	\$ 1,178.00	S/F Starter, 12"D x 72"H			102
S2-863-S00	\$ 890.00	S/F Adder, 12"D x 72"H			87
S1-675-S00	\$ 1,288.00	S/F Starter, 16"D x 72"H			93
S2-675-S00	\$ 1,020.00	S/F Adder, 16"D x 72"H			80
<b>60"H - 4 adjustable shelves, 1 base shelf</b>					
S1-979-S00	\$ 984.00	S/F Starter, 10"D x 60-1/2"H			75
S2-979-S00	\$ 742.00	S/F Adder, 10"D x 60-1/2"H			65
S1-988-S00	\$ 1,064.00	S/F Starter, 12"D x 60-1/2"H			96
S2-988-S00	\$ 805.00	S/F Adder, 12"D x 60-1/2"H			81
S1-678-S00	\$ 1,171.00	S/F Starter, 16"D x 60 1/2"H			88
S2-678-S00	\$ 916.00	S/F Adder, 16"D x 60 1/2"H			75
<b>48"H - 2 adjustable shelves, 1 base shelf</b>					
S1-761-S00	\$ 811.00	S/F Starter, 10"D x 48" H			71
S2-761-S00	\$ 587.00	S/F Adder, 10"D x 48" H			63
S1-762-S00	\$ 866.00	S/F Starter, 12"D x 48" H			84
S2-762-S00	\$ 621.00	S/F Adder, 12"D x 48" H			74
S1-676-S00	\$ 938.00	S/F Starter, 16"D x 48"H			75
S2-676-S00	\$ 690.00	S/F Adder, 16"D x 48"H			65
<b>42"H - 2 adjustable shelves, 1 base shelf</b>					
S1-981-S00	\$ 768.00	S/F Starter, 10"D x 42"H			61
S2-981-S00	\$ 548.00	S/F Adder, 10"D x 42"H			53
S1-989-S00	\$ 817.00	S/F Starter, 12"D x 42"H			74
S2-989-S00	\$ 575.00	S/F Adder, 12"D x 42"H			64
S1-677-S00	\$ 847.00	S/F Starter, 16"D x 42"H			71
S2-677-S00	\$ 601.00	S/F Adder, 16"D x 42"H			63









**Note:** Shelving backs and partitions are located in the Shelving Accessories section.

Please specify Wood Finish. Details can be found in the Product Options section at the front of this Price List.

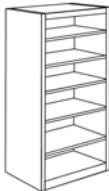
\* For details regarding Maple shelving, Clip & Strip shelving, Sub-tops, or Individual HPL tops, please reference the Product Options section at the front of this price list.

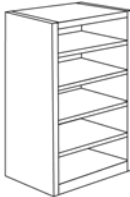

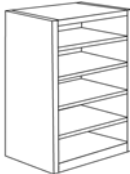
**Wood Shelving**  
**Double Faced Shelving (prices shown in Oak wood\*)**  
**2009 Brodart Furniture - List Prices**

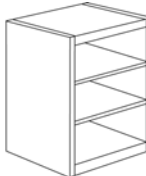
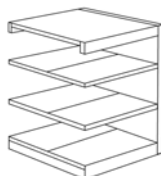
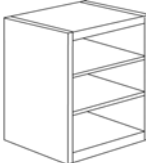
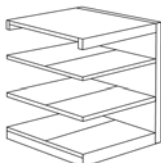
Catalog Number	List Price	Description		Weight (lbs)
<b>90"H D/F - 6 adjustable shelves, 1 base shelf per side</b>				
S1-969-S00	\$ 2,292.00	D/F Starter, 10"D x 90"H		185
S2-969-S00	\$ 1,810.00	D/F Adder, 10"D x 90"H		153
S1-973-S00	\$ 2,481.00	D/F Starter, 12"D x 90"H		224
S2-973-S00	\$ 1,927.00	D/F Adder, 12"D x 90"H		188
<b>82"H D/F - 5 adjustable shelves, 1 base shelf per side</b>				
S1-983-S00	\$ 2,143.00	D/F Starter, 20"D x 82"H		175
S2-983-S00	\$ 1,667.00	D/F Adder, 20"D x 82"H		143
S1-990-S00	\$ 2,335.00	D/F Starter, 24"D x 82"H		214
S2-990-S00	\$ 1,796.00	D/F Adder, 24" Dx 82"H		178
S1-689-S00	\$ 2,596.00	D/F Starter, 32"D x 82"H		185
S2-689-S00	\$ 2,061.00	D/F Adder, 32"D x 82"H		153
<b>72"H D/F - 4 adjustable shelves, 1 base shelf per side</b>				
S1-865-S00	\$ 2,035.00	D/F Starter, 20"D x 72"H		160
S2-865-S00	\$ 1,565.00	D/F Adder, 20"D x 72"H		128
S1-866-S00	\$ 2,196.00	D/F Starter, 24"D x 72"H		199
S2-866-S00	\$ 1,693.00	D/F Adder, 24" Dx 72"H		163
S1-685-S00	\$ 2,330.00	D/F Starter, 32"D x 72"H		175
S2-685-S00	\$ 1,938.00	D/F Adder, 32"D x 72"H		143
<b>60"H D/F - 4 adjustable shelves, 1 base shelf per side</b>				
S1-985-S00	\$ 1,928.00	D/F Starter, 20"D x 60-1/2"H		139
S2-985-S00	\$ 1,461.00	D/F Adder, 20"D x 60-1/2"H		115
S1-986-S00	\$ 2,053.00	D/F Starter, 24"D x 60-1/2"H		170
S2-986-S00	\$ 1,592.00	D/F Adder, 24"D x 60-1/2"H		142
S1-688-S00	\$ 2,259.00	D/F Starter, 32"D x 60 1/2"H		160
S2-688-S00	\$ 1,810.00	D/F Adder, 32"D x 60 1/2"H		128
<b>48"H D/F - 2 adjustable shelves, 1 base shelf per side</b>				
S1-765-S00	\$ 1,470.00	D/F Starter, 20"D x 48"H		111
S2-765-S00	\$ 1,103.00	D/F Adder, 20"D x 48"H		96
S1-766-S00	\$ 1,537.00	D/F Starter, 24"D x 48"H		134
S2-766-S00	\$ 1,179.00	D/F Adder, 24"D x 48"H		111
S1-686-S00	\$ 1,665.00	D/F Starter, 32"D x 48"H		139
S2-686-S00	\$ 1,310.00	D/F Adder, 32"D x 48"H		115
<b>42"H D/F - 2 adjustable shelves, 1 base shelf per side</b>				
S1-987-S00	\$ 1,353.00	D/F Starter, 20"D x 42"H		101
S2-987-S00	\$ 1,012.00	D/F Adder, 20"D x 42"H		86
S1-991-S00	\$ 1,408.00	D/F Starter, 24"D x 42"H		124
S2-991-S00	\$ 1,074.00	D/F Adder, 24" Dx 42"		105
S1-687-S00	\$ 1,474.00	D/F Starter, 32"D x 42"H		111
S2-687-S00	\$ 1,123.00	D/F Adder, 32"D x 42"H		96

**Note:** Shelving backs and partitions are located in the Shelving Accessories section.

**Please specify Wood Finish. Details can be found in the Product Options section at the front of this Price List.**

**\* For details regarding Maple shelving, Clip & Strip shelving, Sub-tops, or Individual HPL tops, please reference the Product Options section at the front of this price list.**

# Wood Shelving

Periodical/Magazine - Tilt & Store Shelving (prices shown in Oak wood\*)

2009 Brodart Furniture - List Prices



Catalog Number	List Price	Description	Weight (lbs)
<b>Shelving Units, Periodical Display</b>			
S1-918-S00	\$ 1,798.00	S/F Starter, 12"D x 82"H	120
S2-918-S00	\$ 1,368.00	S/F Adder, 12"D x 82"H	100
S1-875-S00	\$ 1,560.00	S/F Starter, 12"D x 72"H	114
S2-875-S00	\$ 1,168.00	S/F Adder, 12"D x 72"H	95
S1-920-S00	\$ 1,319.00	S/F Starter, 12"D x 60-1/2"H	105
S2-920-S00	\$ 966.00	S/F Adder, 12"D x 60-1/2"H	90
S1-919-S00	\$ 1,153.00	S/F Starter, 12"D x 48"H	90
S2-919-S00	\$ 892.00	S/F Adder, 12"D x 48"H	80
S1-921-S00	\$ 995.00	S/F Starter, 12"D x 42"H	80
S2-921-S00	\$ 817.00	S/F Adder, 12"D x 42"H	70
S1-922-S00	\$ 3,261.00	D/F Starter, 24"D x 82"H	230
S2-922-S00	\$ 2,747.00	D/F Adder, 24"D x 82"H	194
S1-876-S00	\$ 2,968.00	D/F Starter, 24"D x 72"H	210
S2-876-S00	\$ 2,499.00	D/F Adder, 24"D x 72"H	180
S1-923-S00	\$ 2,348.00	D/F Starter, 24"D x 60-1/2"H	185
S2-923-S00	\$ 1,844.00	D/F Adder, 24"D x 60-1/2"H	157
S1-925-S00	\$ 2,115.00	D/F Starter, 24"D x 48"H	150
S2-925-S00	\$ 1,605.00	D/F Adder, 24"D x 48"H	130
S1-924-S00	\$ 1,885.00	D/F Starter, 24"D x 42"H	130
S2-924-S00	\$ 1,368.00	D/F Adder, 24"D x 42"H	111
<b>Shelving Units, Tilt and Store</b>			
S1-935-S00	\$ 2,177.00	S/F Starter, 16"D x 82"H	250
S2-935-S00	\$ 1,751.00	S/F Adder, 16"D x 82"H	214
S1-880-S00	\$ 1,982.00	S/F Starter, 16"D x 72"H	220
S2-880-S00	\$ 1,593.00	S/F Adder, 16"D x 72"H	180
S1-936-S00	\$ 1,680.00	S/F Starter, 16"D x 60-1/2"H	180
S2-936-S00	\$ 1,276.00	S/F Adder, 16"D x 60-1/2"H	130
S1-938-S00	\$ 1,462.00	S/F Starter, 16"D x 48"H	120
S2-938-S00	\$ 1,119.00	S/F Adder, 16"D x 48"H	110
S1-937-S00	\$ 1,245.00	S/F Starter, 16"D x 42"H	100
S2-937-S00	\$ 962.00	S/F Adder, 16"D x 42"H	90



72" H Unit Shown



82" H Unit Shown

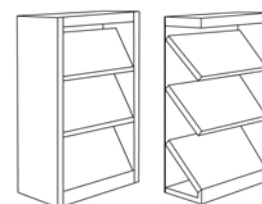

60 1/2" H Unit Shown

**Note:** Shelving backs and partitions are located in the Shelving Accessories section.

**Please specify Wood Finish. Details can be found in the Product Options section at the front of this Price List.**

**\* For details regarding Maple shelving, Clip & Strip shelving, Sub-tops, or Individual HPL tops, please reference the Product Options section at the front of this price list.**

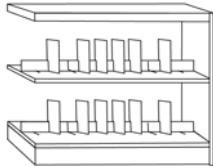
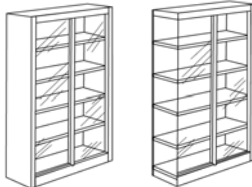

**Wood Shelving**  
**Picture Book - Glass Door Shelving (prices shown in Oak wood\*)**  
**2009 Brodart Furniture - List Prices**

Catalog Number	List Price	Description		Weight (lbs)
<b>Shelving Units, Picture Book</b>				
S1-931-S00	\$ 1,143.00	S/F Starter, 12"D x 60-1/2"H		105
S2-931-S00	\$ 824.00	S/F Adder, 12"D x 60-1/2"H		90
S1-929-S00	\$ 1,057.00	S/F Starter, 12"D x 48"H		86
S2-929-S00	\$ 789.00	S/F Adder, 12"D x 48"H		76
S1-932-S00	\$ 879.00	S/F Starter, 12"D x 42"H		78
S2-932-S00	\$ 630.00	S/F Adder, 12"D x 42"H		68
			60 1/2" H Unit Shown	
S1-933-S00	\$ 2,176.00	D/F Starter, 24"D x 60-1/2"H		180
S2-933-S00	\$ 1,593.00	D/F Adder, 24"D x 60-1/2"H		152
S1-930-S00	\$ 1,690.00	D/F Starter, 24"D x 48"H		149
S2-930-S00	\$ 1,297.00	D/F Adder, 24"D x 48"H		130
S1-934-S00	\$ 1,507.00	D/F Starter, 24"D x 42"H		130
S2-934-S00	\$ 1,229.00	D/F Adder, 24"D x 42"H		110
			42" H Unit Shown	
<b>Shelving Units, Glass Door (Clip and Strip Only)</b>				
S3-950-S00	\$ 3,399.00	S/F Starter, 12"D x 82"H Clip		290
S4-950-S00	\$ 2,987.00	S/F Adder, 12"D x 82"H Clip		260
S3-885-S00	\$ 3,126.00	S/F Starter, 12"D x 72"H Clip		270
S4-885-S00	\$ 2,747.00	S/F Adder, 12"D x 72"H Clip		240
S3-954-S00	\$ 2,877.00	S/F Starter, 12"D x 60-1/2"H Clip		230
S4-954-S00	\$ 2,550.00	S/F Adder, 12"D x 60-1/2"H Clip		200
S3-955-S00	\$ 2,586.00	S/F Starter, 12"D x 48"H Clip		200
S4-955-S00	\$ 2,299.00	S/F Adder, 12"D x 48"H Clip		160
			60 1/2" H Unit Shown	
S3-956-S00	\$ 2,294.00	S/F Starter, 12"D x 42"H Clip		180
S4-956-S00	\$ 2,053.00	S/F Adder, 12"D x 42"H Clip		140

**Note:** Shelving backs and partitions are located in the Shelving Accessories section.

**Please specify Wood Finish. Details can be found in the Product Options section at the front of this Price List.**

**\* For details regarding Maple shelving, Clip & Strip shelving, Sub-tops, or Individual HPL tops, please reference the Product Options section at the front of this price list.**



**Omega Shelving**  
**Single Faced Shelving (prices shown in Oak wood\*)**  
**2009 Brodart Furniture - List Prices**





Catalog Number	List Price	Description			Weight (lbs)
----------------	------------	-------------	--	--	--------------

**Standard Omega w/ Wood Base Shelf**



**90"H - 6 adjustable omega shelves, 1 wood base shelf**

S5-960-S00	\$ 1,110.00	S/F Starter, 10"D x 90"H			103
S6-960-S00	\$ 840.00	S/F Adder, 10"D x 90"H			90
S5-967-S00	\$ 1,247.00	S/F Starter, 12"D x 90"H			122
S6-967-S00	\$ 897.00	S/F Adder, 12"D x 90"H			102



**82"H - 5 adjustable omega shelves, 1 wood base shelf**

S5-976-S00	\$ 1,012.00	S/F Starter, 10"D x 82"H			93
S6-976-S00	\$ 769.00	S/F Adder, 10"D x 82"H			80
S5-977-S00	\$ 1,136.00	S/F Starter, 12"D x 82"H			112
S6-977-S00	\$ 833.00	S/F Adder, 12"D x 82"H			92



**72"H - 4 adjustable omega shelves, 1 wood base shelf**

S5-861-S00	\$ 923.00	S/F Starter, 10"D x 72"H			84
S6-861-S00	\$ 705.00	S/F Adder, 10"D x 72"H			72
S5-863-S00	\$ 1,035.00	S/F Starter, 12"D x 72"H			104
S6-863-S00	\$ 772.00	S/F Adder, 12"D x 72"H			87



**60"H - 4 adjustable omega shelves, 1 wood base shelf**

S5-979-S00	\$ 835.00	S/F Starter, 10"D x 60-1/2"H			75
S6-979-S00	\$ 640.00	S/F Adder, 10"D x 60-1/2"H			65
S5-988-S00	\$ 936.00	S/F Starter, 12"D x 60-1/2"H			96
S6-988-S00	\$ 710.00	S/F Adder, 12"D x 60-1/2"H			81

**48"H - 2 adjustable omega shelves, 1 wood base shelf**

S5-761-S00	\$ 716.00	S/F Starter, 10"D x 48"H			65
S6-761-S00	\$ 523.00	S/F Adder, 10"D x 48"H			57
S5-762-S00	\$ 762.00	S/F Starter, 12"D x 48"H			78
S6-762-S00	\$ 549.00	S/F Adder, 12"D x 48"H			68

**42"H - 2 adjustable omega shelves, 1 wood base shelf**

S5-981-S00	\$ 686.00	S/F Starter, 10"D x 42"H			61
S6-981-S00	\$ 493.00	S/F Adder, 10"D x 42"H			53
S5-989-S00	\$ 718.00	S/F Starter, 12"D x 42"H			74
S6-989-S00	\$ 509.00	S/F Adder, 12"D x 42"H			64

**Note:** Shelving backs and partitions are located in the Shelving Accessories section.

**Please specify Wood Finish and Metal color. Details can be found in the Product Options section at the front of this Price List.**

**\* For details regarding Maple shelving, Clip & Strip shelving, Sub-tops, or Individual HPL tops, please reference the Product Options section at the front of this price list.**



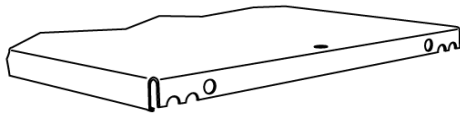



**Omega Shelving**  
**Double Faced Shelving (prices shown in Oak wood\*)**  
**2009 Brodart Furniture - List Prices**



Catalog Number	List Price	Description	Weight (lbs)
----------------	------------	-------------	--------------

**Standard Omega w/ Wood Base Shelf**



**90"H D/F - 6 adjustable omega shelves, 1 wood base shelf per side**

S5-969-S00	\$ 1,864.00	D/F Starter, 20"D x 90"H			185
S6-969-S00	\$ 1,402.00	D/F Adder, 20"D x 90"H			153
S5-973-S00	\$ 2,233.00	D/F Starter, 24"D x 90"H			224
S6-973-S00	\$ 1,550.00	D/F Adder, 24"D x 90"H			188



**82"H D/F - 5 adjustable omega shelves, 1 wood base shelf per side**

S5-983-S00	\$ 1,770.00	D/F Starter 20"D x 82"H			175
S6-983-S00	\$ 1,359.00	D/F Adder 20"D x 82"H			143
S5-990-S00	\$ 2,084.00	D/F Starter 24"D x 82"H			214
S6-990-S00	\$ 1,500.00	D/F Adder 24"D x 82"H			178



**72"H D/F - 4 adjustable omega shelves, 1 wood base shelf per side**

S5-865-S00	\$ 1,681.00	D/F Starter, 20"D x 72"H			160
S6-865-S00	\$ 1,317.00	D/F Adder, 20"D x 72"H			128
S5-866-S00	\$ 1,944.00	D/F Starter, 24"D x 72"H			199
S6-866-S00	\$ 1,451.00	D/F Adder, 24"D x 72"H			163



**60"H D/F - 4 adjustable omega shelves, 1 wood base shelf per side**

S5-985-S00	\$ 1,593.00	D/F Starter, 20"D x 60-1/2"H			139
S6-985-S00	\$ 1,276.00	D/F Adder, 20"D x 60-1/2"H			115
S5-986-S00	\$ 1,805.00	D/F Starter, 24"D x 60-1/2"H			170
S6-986-S00	\$ 1,401.00	D/F Adder, 24"D x 60-1/2"H			142

**48"H D/F - 2 adjustable omega shelves, 1 wood base shelf per side**

S5-765-S00	\$ 1,258.00	D/F Starter, 20"D x 48"H			109
S6-765-S00	\$ 923.00	D/F Adder, 20"D x 48"H			94
S5-766-S00	\$ 1,359.00	D/F Starter, 24"D x 48"H			132
S6-766-S00	\$ 1,020.00	D/F Adder, 24"D x 48"H			109

**42"H D/F - 2 adjustable omega shelves, 1 wood base shelf per side**

S5-987-S00	\$ 1,175.00	D/F Starter, 20"D x 42"H			101
S6-987-S00	\$ 835.00	D/F Adder, 20"D x 42"H			86
S5-991-S00	\$ 1,247.00	D/F Starter, 24"D x 42"H			124
S6-991-S00	\$ 925.00	D/F Adder, 24"D x 42"H			105

**Note:** Shelving backs and partitions are located in the Shelving Accessories section.

**Please specify Wood Finish and Metal color. Details can be found in the Product Options section at the front of this Price List.**

**\* For details regarding Maple shelving, Clip & Strip shelving, Sub-tops, or Individual HPL tops, please reference the Product Options section at the front of this price list.**

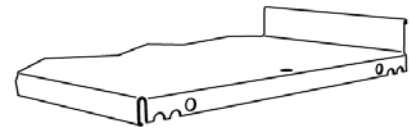

**Book-Stop Omega Shelving**  
**Single Faced Shelving (prices shown in Oak wood\*)**  
**2009 Brodart Furniture - List Prices**





Catalog Number	List Price	Description			Weight (lbs)
----------------	------------	-------------	--	--	--------------

**Book-Stop Omega w/Book-Stop Base Shelf**

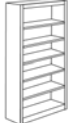

**90"H - 6 adjustable book stop shelves, 1 base book stop shelf**

S7-960-S00	\$ 1,110.00	S/F Starter, 10"D x 90"H			103
S8-960-S00	\$ 840.00	S/F Adder, 10"D x 90"H			90
S7-967-S00	\$ 1,247.00	S/F Starter, 12"D x 90"H			122
S8-967-S00	\$ 897.00	S/F Adder, 12"D x 90"H			102



**82"H - 5 adjustable book stop shelves, 1 base book stop shelf**

S7-976-S00	\$ 1,133.00	S/F Starter, 10"D x 82"H, b/s			93
S8-976-S00	\$ 883.00	S/F Adder, 10"D x 82"H, b/s			80
S7-977-S00	\$ 1,276.00	S/F Starter, 12"D x 82"H, b/s			112
S8-977-S00	\$ 949.00	S/F Adder, 12"D x 82"H, b/s			92

**72"H - 4 adjustable book stop shelves, 1 base book stop shelf**

S7-861-S00	\$ 1,015.00	S/F Starter, 10"D x 72"H, b/s			84
S8-861-S00	\$ 792.00	S/F Adder, 10"D x 72"H, b/s			72
S7-863-S00	\$ 1,159.00	S/F Starter, 12"D x 72"H, b/s			104
S8-863-S00	\$ 860.00	S/F Adder, 12"D x 72"H, b/s			87



**60"H - 4 adjustable book stop shelves, 1 base book stop shelf**

S7-979-S00	\$ 897.00	S/F Starter, 10"D x 60-1/2"H, b/s			75
S8-979-S00	\$ 702.00	S/F Adder, 10"D x 60-1/2"H, b/s			65
S7-988-S00	\$ 1,044.00	S/F Starter, 12"D x 60-1/2"H, b/s			96
S8-988-S00	\$ 771.00	S/F Adder, 12"D x 60-1/2"H, b/s			81

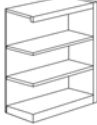
**48"H - 2 adjustable book stop shelves, 1 base book stop shelf**

S7-761-S00	\$ 755.00	S/F Starter, 10"D x 48"H, b/s			66
S8-761-S00	\$ 562.00	S/F Adder, 10"D x 48"H, b/s			58
S7-762-S00	\$ 818.00	S/F Starter, 12"D x 48"H, b/s			79
S8-762-S00	\$ 592.00	S/F Adder, 12"D x 48"H, b/s			69

**42"H - 2 adjustable book stop shelves, 1 base book stop shelf**

S7-981-S00	\$ 719.00	S/F Starter, 10"D x 42"H, b/s			61
S8-981-S00	\$ 526.00	S/F Adder, 10"D x 42"H, b/s			53
S7-989-S00	\$ 762.00	S/F Starter, 12"D x 42"H, b/s			74
S8-989-S00	\$ 549.00	S/F Adder, 12"D x 42"H, b/s			64

**Note:** Shelving backs and partitions cannot be used with Book Stop Shelving.

**Please specify Wood Finish and Metal color. Details can be found in the Product Options section at the front of this Price List.**

**\* For details regarding Maple shelving, Clip & Strip shelving, Sub-tops, or Individual HPL tops, please reference the Product Options section at the front of this price list.**

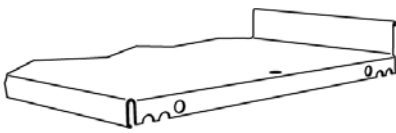



**Book-Stop Omega Shelving**  
**Double Faced Shelving (prices shown in Oak wood\*)**  
**2009 Brodart Furniture - List Prices**



Catalog Number	List Price	Description	Weight (lbs)
----------------	------------	-------------	--------------

**Book-Stop Omega w/Book-Stop Base Shelf**



**90"H D/F - 6 adjustable book stop shelves, 1 base book stop shelf per side**

S7-969-S00	\$ 2,167.00	D/F Starter, 20"D x 90"H			185
S8-969-S00	\$ 1,687.00	D/F Adder, 20"D x 90"H			153
S7-973-S00	\$ 2,550.00	D/F Starter, 24"D x 90"H			224
S8-973-S00	\$ 1,842.00	D/F Adder, 24"D x 90"H			188



**82"H D/F - 5 adjustable book stop shelves, 1 base book stop shelf per side**

S7-983-S00	\$ 2,009.00	D/F Starter, 20"D x 82"H, b/s			175
S8-983-S00	\$ 1,586.00	D/F Adder, 20"D x 82"H, b/s			143
S7-990-S00	\$ 2,330.00	D/F Starter, 24"D x 82"H, b/s			214
S8-990-S00	\$ 1,726.00	D/F Adder, 24"D x 82"H, b/s			178



**72"H D/F - 4 adjustable book stop shelves, 1 base book stop shelf per side**

S7-865-S00	\$ 1,862.00	D/F Starter, 20"D x 72"H, b/s			160
S8-865-S00	\$ 1,491.00	D/F Adder, 20"D x 72"H, b/s			128
S7-866-S00	\$ 2,128.00	D/F Starter, 24"D x 72"H, b/s			199
S8-866-S00	\$ 1,616.00	D/F Adder, 24"D x 72"H, b/s			163



**60"H D/F - 4 adjustable book stop shelves, 1 base book stop shelf per side**

S7-985-S00	\$ 1,714.00	D/F Starter, 20"D x 60-1/2"H, b/s			139
S8-985-S00	\$ 1,398.00	D/F Adder, 20"D x 60-1/2"H, b/s			115
S7-986-S00	\$ 1,925.00	D/F Starter, 24"D x 60-1/2"H, b/s			170
S8-986-S00	\$ 1,508.00	D/F Adder, 24"D x 60-1/2"H, b/s			142

**48"H D/F - 2 adjustable book stop shelves, 1 base book stop shelf per side**

S7-765-S00	\$ 1,337.00	D/F Starter, 20"D x 48"H b/s			111
S8-765-S00	\$ 1,002.00	D/F Adder, 20"D x 48"H b/s			96
S7-766-S00	\$ 1,438.00	D/F Starter, 24"D x 48"H b/s			134
S8-766-S00	\$ 1,096.00	D/F Adder, 24"D x 48"H b/s			111

**42"H D/F - 2 adjustable book stop shelves, 1 base book stop shelf per side**

S7-987-S00	\$ 1,244.00	D/F Starter, 20"D x 42"H, b/s			101
S8-987-S00	\$ 903.00	D/F Adder, 20"D x 42"H, b/s			86
S7-991-S00	\$ 1,316.00	D/F Starter, 24"D x 42"H, b/s			124
S8-991-S00	\$ 992.00	D/F Adder, 24"D x 42"H, b/s			105

**Note:** Shelving backs and partitions cannot be used with Book Stop Shelving.

**Please specify Wood Finish and Metal color. Details can be found in the Product Options section at the front of this Price List.**

**\* For details regarding Maple shelving, Clip & Strip shelving, Sub-tops, or Individual HPL tops, please reference the Product Options section at the front of this price list.**

# Omega Shelving

Periodical/Magazine - Tilt & Store Shelving (prices shown in Oak wood\*)

2009 Brodart Furniture - List Prices

Catalog Number	List Price	Description	Weight (lbs)
<b>Shelving Units, Periodical Display</b>			
S7-918-S00	\$ 1,798.00	S/F Starter, 12"D x 82"H	120
S8-918-S00	\$ 1,368.00	S/F Adder, 12"D x 82"H	100
S7-875-S00	\$ 1,560.00	S/F Starter, 12"D x 72"H	114
S8-875-S00	\$ 1,168.00	S/F Adder, 12"D x 72"H	95
S7-920-S00	\$ 1,319.00	S/F Starter, 12"D x 60-1/2"H	105
S8-920-S00	\$ 966.00	S/F Adder, 12"D x 60-1/2"H	90
S7-919-S00	\$ 1,153.00	S/F Starter, 12"D x 48"H	90
S8-919-S00	\$ 892.00	S/F Adder, 12"D x 48"H	80
S7-921-S00	\$ 995.00	S/F Starter, 12"D x 42"H	80
S8-921-S00	\$ 817.00	S/F Adder, 12"D x 42"H	70
S7-922-S00	\$ 3,261.00	D/F Starter, 24"D x 82"H	230
S8-922-S00	\$ 2,747.00	D/F Adder, 24"D x 82"H	194
S7-876-S00	\$ 2,968.00	D/F Starter, 24"D x 72"H	210
S8-876-S00	\$ 2,499.00	D/F Adder, 24"D x 72"H	180
S7-923-S00	\$ 2,348.00	D/F Starter, 24"D x 60-1/2"H	185
S8-923-S00	\$ 1,844.00	D/F Adder, 24"D x 60-1/2"H	157
S7-925-S00	\$ 2,115.00	D/F Starter, 24"D x 48"H	150
S8-925-S00	\$ 1,605.00	D/F Adder, 24"D x 48"H	130
S7-924-S00	\$ 1,885.00	D/F Starter, 24"D x 42"H	130
S8-924-S00	\$ 1,368.00	D/F Adder, 24"D x 42"H	111
<b>Shelving Units, Tilt and Store</b>			
S7-935-S00	\$ 2,256.00	S/F Starter, 16"D x 82"H	250
S8-935-S00	\$ 1,895.00	S/F Adder, 16"D x 82"H	214
S7-880-S00	\$ 2,141.00	S/F Starter, 16"D x 72"H	220
S8-880-S00	\$ 1,682.00	S/F Adder, 16"D x 72"H	180
S7-936-S00	\$ 2,025.00	S/F Starter, 16"D x 60-1/2"H	180
S8-936-S00	\$ 1,468.00	S/F Adder, 16"D x 60-1/2"H	130
S7-938-S00	\$ 1,806.00	S/F Starter, 16"D x 48"H	120
S8-938-S00	\$ 1,382.00	S/F Adder, 16"D x 48"H	110
S7-937-S00	\$ 1,588.00	S/F Starter, 16"D x 42"H	100
S8-937-S00	\$ 1,296.00	S/F Adder, 16"D x 42"H	90

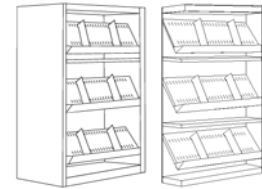

60 1/2" H Unit Shown



82" H Unit Shown

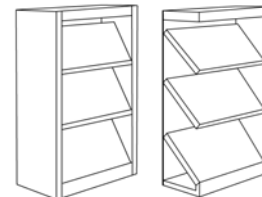

60 1/2" H Unit Shown

**Note:** Shelving backs and partitions are located in the Shelving Accessories section.

Please specify Wood Finish and Metal color. Details can be found in the Product Options section at the front of this Price List.

\* For details regarding Maple shelving, Clip & Strip shelving, Sub-tops, or Individual HPL tops, please reference the Product Options section at the front of this price list.

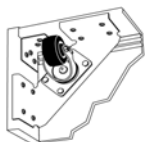

**Mobile Shelving**  
**Double Faced, Caster Base Shelving (prices shown in Oak wood\*)**  
**2009 Brodart Furniture - List Prices**

Catalog Number	List Price	Description	Weight (lbs)
----------------	------------	-------------	--------------

**Wood Shelving, Partitions Included**

S1-991-S07	\$ 1,745.00	D/F Starter 24"D x 42"H	140
S1-766-S07	\$ 1,870.00	D/F Starter 24"D x 48"H	154
S1-986-S07	\$ 2,372.00	D/F Starter 24"D x 60-1/2"H	190
S1-991-S08	\$ 3,138.00	D/F Starter/Adder 24"D x 42"H	269
S1-766-S08	\$ 3,367.00	D/F Starter/Adder 24"D x 48"H	285
S1-986-S08	\$ 4,269.00	D/F Starter/Adder 24"D x 60-1/2"H	352

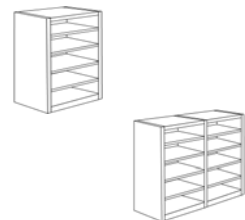

60 1/2" H Unit Shown

**Picture Book Shelving, Partitions Included**

S1-934-S07	\$ 1,842.00	D/F Starter 24"D x 42"H	130
S1-930-S07	\$ 2,018.00	D/F Starter 24"D x 48"H	149
S1-933-S07	\$ 2,490.00	D/F Starter 24"D x 60 1/2"H	180
S1-934-S08	\$ 3,386.00	D/F Starter/Adder 24"D x 42"H	269
S1-930-S08	\$ 3,630.00	D/F Starter/Adder 24"D x 48"H	285
S1-933-S08	\$ 4,389.00	D/F Starter/Adder 24"D x 60 1/2"H	352

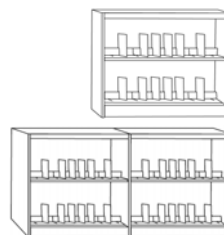

48" H Unit Shown

**Standard Omega w/ Wood Base Shelf, Partitions Included**

S5-991-S07	\$ 1,769.00	D/F Starter 24"D x 42"H	140
S5-766-S07	\$ 1,980.00	D/F Starter 24"D x 48"H	154
S5-986-S07	\$ 3,020.00	D/F Starter 24"D x 60"H	190
S5-991-S08	\$ 3,237.00	D/F Starter/Adder 24"D x 42"H	269
S5-766-S08	\$ 3,468.00	D/F Starter/Adder 24"D x 48"H	285
S5-986-S08	\$ 5,146.00	D/F Starter/Adder 24"D x 60"H	352

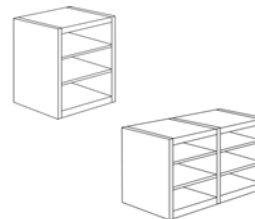

42" H Unit Shown

**Book-Stop Omega w/ Book-Stop Base Shelf, Sway Braces Included**

S7-991-S07	\$ 1,883.00	D/F Starter 24"D x 42"H	140
S7-766-S07	\$ 2,091.00	D/F Starter 24"D x 48"H	154
S7-986-S07	\$ 3,132.00	D/F Starter 24"D x 60"H	190
S7-991-S08	\$ 3,375.00	D/F Starter/Adder 24"D x 42"H	269
S7-766-S08	\$ 3,606.00	D/F Starter/Adder 24"D x 48"H	285
S7-986-S08	\$ 5,284.00	D/F Starter/Adder 24"D x 60"H	352

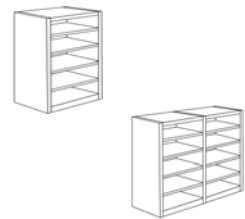

60 1/2" H Unit Shown

**Note:** Shelving backs and partitions cannot be used with Book Stop Shelving.

**Please specify Wood Finish and Metal color (if applicable). Details can be found in the Product Options section at the front of this Price List.**

**\* For details regarding Maple shelving, Clip & Strip shelving, Sub-tops, or Individual HPL tops, please reference the Product Options section at the front of this price list.**

**Shelving Parts & Accessories**  
**Shelving Accessories (prices shown in Oak wood)**  
**2009 Brodart Furniture - List Prices**

Catalog Number	List Price	Description	Weight (lbs)
----------------	------------	-------------	--------------

**Seismic Anchors (upcharge per unit)**

EQSFSTART	\$ 109.00	Seismic Anchors, S/F Starter, per unit
EQSFADD	\$ 67.00	Seismic Anchors, S/F Adder, per unit
EQDFSTART	\$ 218.00	Seismic Anchors, D/F Starter, per unit
EQDFADD	\$ 129.00	Seismic Anchors, D/F Adder, per unit

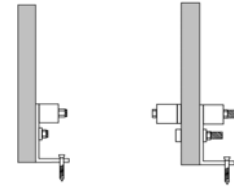

**Shelving Backs & Partitions**

**S/F Shelving Backs-(Plywood w/Oak Face Veneer)**

SB-608-S00	\$ 164.00	S/F Shelving Back, Oak, 90" H	24
SB-600-S00	\$ 158.00	S/F Shelving Back, Oak, 82" H	22
SB-620-S00	\$ 155.00	S/F Shelving Back, Oak, 72"H	20
SB-602-S00	\$ 151.00	S/F Shelving Back, Oak, 60-1/2" H	18
SB-606-S00	\$ 106.00	S/F Shelving Back, Oak, 48"H	15
SB-604-S00	\$ 95.00	S/F Shelving Back, Oak, 42" H	12



**S/F Shelving Backs-(Painted)**

SB-940-S00	\$ 136.00	S/F Shelving Back, Painted, 90" H	24
SB-939-S00	\$ 129.00	S/F Shelving Back, Painted, 82" H	22
SB-960-S00	\$ 127.00	S/F Shelving Back, Painted, 72"H	20
SB-942-S00	\$ 124.00	S/F Shelving Back, Painted, 60-1/2" H	18
SB-948-S00	\$ 86.00	S/F Shelving Back, Painted, 48"H	15
SB-943-S00	\$ 76.00	S/F Shelving Back, Painted, 42" H	12



**D/F Shelving Partitions-(Plywood w/Oak Face Veneer)**

SB-609-S00	\$ 213.00	D/F Shelving Partition, Oak, 90" H	24
SB-601-S00	\$ 206.00	D/F Shelving Partition, Oak, 82" H	22
SB-621-S00	\$ 193.00	D/F Shelving Partition, Oak, 72"H	20
SB-603-S00	\$ 178.00	D/F Shelving Partition, Oak, 60-1/2" H	18
SB-607-S00	\$ 132.00	D/F Shelving Partition, Oak, 48"H	15
SB-605-S00	\$ 119.00	D/F Shelving Partition, Oak, 42" H	12



**D/F Shelving Partitions-(Painted)**

SB-941-S00	\$ 158.00	D/F Shelving Partition, Painted, 90" H	24
SB-945-S00	\$ 151.00	D/F Shelving Partition, Painted, 82" H	22
SB-961-S00	\$ 142.00	D/F Shelving Partition, Painted, 72"H	20
SB-947-S00	\$ 132.00	D/F Shelving Partition, Painted, 60-1/2" H	18
SB-950-S00	\$ 98.00	D/F Shelving Partition, Painted, 48"H	15
SB-949-S00	\$ 91.00	D/F Shelving Partition, Painted, 42" H	12



**Please specify Wood Finish or Paint color (if applicable). Details can be found in the Product Options section at the front of this Price List.**

**Shelving Parts & Accessories**  
**Shelving Accessories (prices shown in Oak wood)**  
**2009 Brodart Furniture - List Prices**

Catalog Number	List Price	Description	Weight (lbs)
<b>Shelf Options/Inserts</b>			
<b>Shelving Inserts</b>			
S1-968-S00	\$ 629.00	Newspaper File Insert	20
S1-862-S00	\$ 442.00	Bulletin Board Insert	20
S6-120-S00	\$ 535.00	Pullout Reference Shelf, 12"D	20
S6-122-S00	\$ 757.00	Pullout CD-DVD Shelf, 12"D	30
<b>Wood Shelves</b>			
60-061-S00	\$ 70.00	12" Shelf Wood	8
60-060-S00	\$ 65.00	10" Shelf Wood	7
60-965-S00	\$ 168.00	Sloping Wood Periodical Shelf	9
60-062-S00	\$ 100.00	12" Picture Book Shelf w/ Hardboard Dividers	21
6096711	\$ 6.00	Hardboard Dividers for Picture Book Shelves	1
SHPICBK0AK	\$ 161.00	12" Picture Book Shelf w/ (6) 3/4" x 7 3/4"H Oak Dividers	25
<b>Metal Shelves</b>			
73-004-S00	\$ 58.00	12" Omega Shelf	8
73-003-S00	\$ 53.00	10" Omega Shelf	7
73-002-S00	\$ 60.00	12" Omega Book Stop Shelf	9
73-001-S00	\$ 55.00	10" Omega Book Stop Shelf	8
S6-102-S00	\$ 197.00	Metal Media Display Shelf w/ 6 Dividers	20
S6-103-S00	\$ 154.00	Metal Divider/Picture Book Shelf w/ 4 Dividers	20
<b>Shelving Parts</b>			
<b>Shelving Parts, Bases/Base Shelves</b>			
6096795	\$ 100.00	12" Picture Book Base	6
1836341	\$ 179.00	16" Base	7
1836351	\$ 142.00	12" Base	6
1836361	\$ 129.00	10" Base	6
1836382OAK	\$ 179.00	16" Base shelf, single-faced	10
1836392OAK	\$ 142.00	12" Base shelf, single-faced	9
1836402OAK	\$ 129.00	10" Base shelf, single-faced	8
DH836392OAK	\$ 142.00	12" Base shelf, double-faced	9
DH836402OAK	\$ 129.00	10" Base shelf, double-faced	8
6096795OAK	\$ 167.00	12" Base shelf, picture book, single-faced	21
6096790OAK	\$ 154.00	12" Base shelf, picture book, double-faced	21
1836397OAK	\$ 154.00	12" Base shelf, glass door, single-faced	9
D1836392	\$ 142.00	12" Base D/F *	6
D1836402	\$ 129.00	10" Base D/F *	6

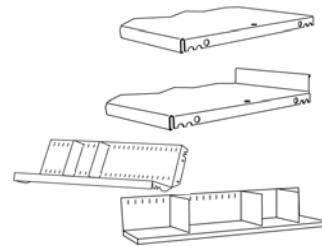

\* **Note:** For D/F shelving you must order one base shelf per side of unit

**Please specify Wood Finish or Metal color (if applicable). Details can be found in the Product Options section at the front of this Price List.**

**Shelving Parts & Accessories**  
**Shelving Parts (prices shown in Oak wood)**  
**2009 Brodart Furniture - List Prices**

Catalog Number	List Price	Description	Weight (lbs)
<b>Shelving Tops</b>			
**Please specify shelving height that top is to be used on**			
1836311	\$ 218.00	High-12" Top	9
1836321	\$ 202.00	High-10" Top	8
1836271	\$ 328.00	High-24" Top	17
1836281	\$ 304.00	High-20" Top	15
1836312	\$ 218.00	Low-12" Top	9
1836322	\$ 202.00	Low-10" Top	8
1836272	\$ 328.00	Low-24" Top	17
1836282	\$ 304.00	Low-20" Top	15
<b>Shelving End Panels-Pin and Hole</b>			
2900210	\$ 314.00	S/F 12"D X 82"H - Left	17
2900211	\$ 314.00	S/F 12"D X 82"H - Right	17
2900212	\$ 289.00	S/F 10"D X 82"H - Left	15
2900213	\$ 289.00	S/F 10"D X 82"H - Right	15
2900203	\$ 536.00	D/F 24"D X 82"H	<b>33</b>
2900202	\$ 511.00	D/F 20"D X 82"H	21
2900201	\$ 483.00	D/F 16"D X 82"H	23
2900274	\$ 301.00	S/F 12"D X 72"H - Left	15
2900275	\$ 301.00	S/F 12"D X 72"H - Right	15
2900276	\$ 260.00	S/F 10"D X 72"H - Left	13
2900277	\$ 260.00	S/F 10"D X 72"H - Right	13
2900281	\$ 492.00	D/F 24"D X 72"H	29
2900280	\$ 468.00	D/F 20"D X 72"H	20
2900218	\$ 241.00	S/F 12"D X 60-1/2"H - Left	13
2900219	\$ 241.00	S/F 12"D X 60-1/2"H - Right	13
2900220	\$ 230.00	S/F 10"D X 60-1/2"H - Left	11
2900221	\$ 230.00	S/F 10"D X 60-1/2"H - Right	11
2900206	\$ 408.00	D/F 24"D X 60-1/2"H	25
2900205	\$ 370.00	D/F 20"D X 60-1/2"H	21

**Please specify Wood Finish. Details can be found in the Product Options section at the front of this Price List.**



**Shelving Parts & Accessories**  
**Shelving Parts (prices shown in Oak wood)**  
**2009 Brodart Furniture - List Prices**

Catalog Number	List Price	Description	Weight (lbs)
2900251	\$ 197.00	S/F 12" D x 48"H - Left	12
2900252	\$ 197.00	S/F 12" D x 48"H - Right	12
2900253	\$ 183.00	S/F 10" D x 48"H - Left	10
2900254	\$ 183.00	S/F 10" D x 48"H - Right	10
2900250	\$ 319.00	D/F 24"D x 48"H	21
2900249	\$ 296.00	D/F 20"D x 48"H	19
2900226	\$ 178.00	S/F 12"D X 42"H - Left	10
2900227	\$ 178.00	S/F 12"D X 42"H - Right	10
2900228	\$ 164.00	S/F 10"D X 42"H - Left	9
2900229	\$ 164.00	S/F 10"D X 42"H - Right	9
2900209	\$ 276.00	D/F 24"D X 42"H	18
2900208	\$ 261.00	D/F 20"D X 42"H	17
<b>Shelving-Intermediate Panels-Pin and Hole</b>			
1836051	\$ 323.00	S/F 12"D X 82"H	17
1836071	\$ 295.00	S/F 10"D X 82"H	14
1835851	\$ 548.00	D/F 24"D X 82"H	33
1835871	\$ 380.00	D/F 20"D X 82"H	27
1836054	\$ 380.00	S/F 12"D X 72"H	16
1836053	\$ 486.00	S/F 10"D X 72"H	14
1835831	\$ 266.00	D/F 24"D X 72"H	31
1835841	\$ 286.00	D/F 20"D X 72"H	26
1836131	\$ 248.00	S/F 12"D X 60-1/2"H	15
1836151	\$ 236.00	S/F 10"D X 60-1/2"H	13
1835911	\$ 420.00	D/F 24"D X 60-1/2"H	29
1835931	\$ 382.00	D/F 20"D X 60-1/2"H	25
1836133	\$ 203.00	S/F 12"D x 48"H	12
1836134	\$ 190.00	S/F 10"D x 48"H	11
1835933	\$ 330.00	D/F 24"D x 48"H	24
1835932	\$ 306.00	D/F 20"D x 48"H	21
1836211	\$ 182.00	S/F 12"D X 42"H	10
1836231	\$ 168.00	S/F 10"D X 42"H	9
1835971	\$ 285.00	D/F 24"D X 42"H	19
1835991	\$ 272.00	D/F 20"D X 42"H	17

**Note:** All End and Intermediate Panels are drilled and/or bushed for use with Brodart shelving only.

**Please specify Wood Finish. Details can be found in the Product Options section at the front of this Price List.**

**Shelving Modifications & Up Charges**  
**Shelving Parts (prices shown in Oak wood)**  
**2009 Brodart Furniture - List Prices**

Catalog Number	List Price	Description	Weight (lbs)
----------------	------------	-------------	--------------

**Shelving Modifications**

BNE	14%	added to starter unit net price - Bull Nose End panel	
BNS	5%	added to starter unit net price - Bull Nose Shelves	
BNT	\$ 58.00	Bull Nose Fascia on Shelving Top Single-Faced	
BNT	\$ 120.00	Bull Nose Fascia on Shelving Top Double-Faced	
FT	\$ 58.00	Fluted Fascia on Shelving Top Single-Faced	
FT	\$ 120.00	Fluted Fascia on Shelving Top Double-Faced	
DT	\$ 58.00	Dentil Fascia on Shelving Top Single-Faced	
DT	\$ 120.00	Dentil Fascia on Shelving Top Double-Faced	
AT	\$ 58.00	Arched Fascia on Shelving Top Single-Faced	
AT	\$ 120.00	Arched Fascia on Shelving Top Double-Faced	
SBS	\$ 40.00	Sloping Base Shelving Option	

**Note:** The catalog numbers listed above are to be used as an add-on to the standard catalog number.

Example: S1-977-S00-BNE-BNS-FT-SBS

This unit would be an 82" x 12" S/F unit with bull nose end panels, bull nose shelves, fluted top and sloping base shelf.

**Shelving Upcharges**

MOD	\$ 21.00	Undersized Backs & Partitions
MOD	\$ 117.00	Oversized Backs & Partitions-up to 42"W
MOD	\$ 87.00	Mod Height Shelving-Starter Unit-Undersize Only
MOD	\$ 53.00	Mod Height Shelving-Adder Unit-Undersize Only
MOD	\$ 196.00	Mod Width Shelving, Undersize
MOD	\$ 527.00	Mod Width Shelving-Wood Only, (Oversize to 42")
MOD	\$ 395.00	Shelving Range Reducer Panel (SKETCH REQUIRED)
MOD	\$ 305.00	Finish & Band Back Side of S/F Shelving Unit-Starter*
MOD	\$ 226.00	Finish & Band Back Side of S/F Shelving Unit-Adder*

\* Backs must be ordered separately

**Note:** Omega shelving cannot be supplied oversized

**Filler Panel Pricing**

SHELVMOD	\$ 26.00	Per Sq Ft price for plywood(Excluding Edge Banding)
SHELVMOD	\$ 6.00	Per Lineal Ft price for edge banding, 1" x 1/4"
SHELVMOD	\$ 120.00	Per Corner Filler Cap

**Deletion of Shelves Per Unit**

MOD	deduct \$10 net	Deletion of 10" Wood Shelf
MOD	deduct \$12 net	Deletion of 12" Wood Shelf
MOD	deduct \$8 net	Deletion of 10" Omega Shelf
MOD	deduct \$10 net	Deletion of 12" Omega Shelf

**Note:** Price listed for shelf deletion is **net price, per shelf.**

**Shelving Modifications & Up Charges**  
**Shelving Parts (prices shown in Oak wood)**  
**2009 Brodart Furniture - List Prices**

**Continuous Tops for Wood Shelving (1 3/16")**  
**64 Series - Internal Edge Band (prices shown in Oak wood)**  
**2009 Brodart Furniture - List Prices**

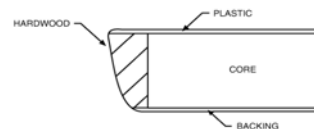

Catalog Number	List Price	Description	Weight (lbs)
64-W10-S01	\$ 210.00	S/F 10"D, To Cover One Unit, Wood	7
64-W12-S01	\$ 215.00	S/F 12"D, To Cover One Unit, Wood	9
64-W20-S01	\$ 312.00	D/F 20"D, To Cover One Unit, Wood	14
64-W24-S01	\$ 354.00	D/F 24"D, To Cover One Unit, Wood	17
64-W10-S02	\$ 293.00	S/F 10"D, To Cover Two Units, Wood	14
64-W12-S02	\$ 311.00	S/F 12"D, To Cover Two Units, Wood	18
64-W20-S02	\$ 440.00	D/F 20"D, To Cover Two Units, Wood	28
64-W24-S02	\$ 554.00	D/F 24"D, To Cover Two Units, Wood	34
64-W10-S03	\$ 392.00	S/F 10"D, To Cover Three Units, Wood	21
64-W12-S03	\$ 410.00	S/F 12"D, To Cover Three Units, Wood	27
64-W20-S03	\$ 558.00	D/F 20"D, To Cover Three Units, Wood	42
64-W24-S03	\$ 587.00	D/F 24"D, To Cover Three Units, Wood	51
64-W10-S04	\$ 584.00	S/F 10"D, To Cover Four Units, Wood	28
64-W12-S04	\$ 620.00	S/F 12"D, To Cover Four Units, Wood	36
64-W20-S04	\$ 871.00	D/F 20"D, To Cover Four Units, Wood	56
64-W24-S04	\$ 938.00	D/F 24"D, To Cover Four Units, Wood	68
64-W10-S05	\$ 676.00	S/F 10"D, To Cover Five Units, Wood	35
64-W12-S05	\$ 723.00	S/F 12"D, To Cover Five Units, Wood	45
64-W20-S05	\$ 997.00	D/F 20"D, To Cover Five Units, Wood	70
64-W24-S05	\$ 1,141.00	D/F 24"D, To Cover Five Units, Wood	85
64-W10-S06	\$ 764.00	S/F 10"D, To Cover Six Units, Wood	42
64-W12-S06	\$ 819.00	S/F 12"D, To Cover Six Units, Wood	54
64-W20-S06	\$ 1,113.00	D/F 20"D, To Cover Six Units, Wood	84
64-W24-S06	\$ 1,174.00	D/F 24"D, To Cover Six Units, Wood	102
64-W10-S07	\$ 969.00	S/F 10"D, To Cover Seven Units, Wood	49
64-W12-S07	\$ 1,030.00	S/F 12"D, To Cover Seven Units, Wood	63
64-W20-S07	\$ 1,427.00	D/F 20"D, To Cover Seven Units, Wood	98
64-W24-S07	\$ 1,525.00	D/F 24"D, To Cover Seven Units, Wood	119
64-W10-S08	\$ 1,057.00	S/F 10"D, To Cover Eight Units, Wood	56
64-W12-S08	\$ 1,128.00	S/F 12"D, To Cover Eight Units, Wood	72
64-W20-S08	\$ 1,554.00	D/F 20"D, To Cover Eight Units, Wood	112
64-W24-S08	\$ 1,730.00	D/F 24"D, To Cover Eight Units, Wood	136
64-W10-S09	\$ 1,146.00	S/F 10"D, To Cover Nine Units, Wood	63
64-W12-S09	\$ 1,228.00	S/F 12"D, To Cover Nine Units, Wood	81
64-W20-S09	\$ 1,671.00	D/F 20"D, To Cover Nine Units, Wood	126
64-W24-S09	\$ 1,759.00	D/F 24"D, To Cover Nine Units, Wood	153

**Please specify Wood Finish and Plastic Laminate. Details can be found in the Product Options section at the front of this Price List.**

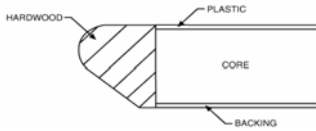

**Continuous Tops for Wood Shelving (1 3/16")**  
**Chancellor Collection (prices shown in Oak wood)**  
**2009 Brodart Furniture - List Prices**

Catalog Number	List Price	Description	Weight (lbs)
<b>Edge banding on the end of tops receive mitred corners</b>			
CH2-W10-S01	\$ 337.00	S/F 10"D, To Cover One Unit, Wood	11
CH2-W12-S01	\$ 356.00	S/F 12"D, To Cover One Unit, Wood	14
CH2-W20-S01	\$ 584.00	D/F 20"D, To Cover One Unit, Wood	23
CH2-W24-S01	\$ 625.00	D/F 24"D, To Cover One Unit, Wood	27
CH2-W10-S02	\$ 461.00	S/F 10"D, To Cover Two Units, Wood	22
CH2-W12-S02	\$ 500.00	S/F 12"D, To Cover Two Units, Wood	28
CH2-W20-S02	\$ 824.00	D/F 20"D, To Cover Two Units, Wood	46
CH2-W24-S02	\$ 913.00	D/F 24"D, To Cover Two Units, Wood	54
CH2-W10-S03	\$ 575.00	S/F 10"D, To Cover Three Units, Wood	33
CH2-W12-S03	\$ 640.00	S/F 12"D, To Cover Three Units, Wood	42
CH2-W20-S03	\$ 1,115.00	D/F 20"D, To Cover Three Units, Wood	69
CH2-W24-S03	\$ 1,155.00	D/F 24"D, To Cover Three Units, Wood	81
CH2-W10-S04	\$ 777.00	S/F 10"D, To Cover Four Units, Wood	44
CH2-W12-S04	\$ 857.00	S/F 12"D, To Cover Four Units, Wood	56
CH2-W20-S04	\$ 1,388.00	D/F 20"D, To Cover Four Units, Wood	92
CH2-W24-S04	\$ 1,566.00	D/F 24"D, To Cover Four Units, Wood	108
CH2-W10-S05	\$ 881.00	S/F 10"D, To Cover Five Units, Wood	55
CH2-W12-S05	\$ 997.00	S/F 12"D, To Cover Five Units, Wood	70
CH2-W20-S05	\$ 1,680.00	D/F 20"D, To Cover Five Units, Wood	115
CH2-W24-S05	\$ 1,808.00	D/F 24"D, To Cover Five Units, Wood	135
CH2-W10-S06	\$ 1,008.00	S/F 10"D, To Cover Six Units, Wood	66
CH2-W12-S06	\$ 1,137.00	S/F 12"D, To Cover Six Units, Wood	84
CH2-W20-S06	\$ 1,972.00	D/F 20"D, To Cover Six Units, Wood	138
CH2-W24-S06	\$ 2,053.00	D/F 24"D, To Cover Six Units, Wood	162
CH2-W10-S07	\$ 1,208.00	S/F 10"D, To Cover Seven Units, Wood	77
CH2-W12-S07	\$ 1,353.00	S/F 12"D, To Cover Seven Units, Wood	98
CH2-W20-S07	\$ 2,244.00	D/F 20"D, To Cover Seven Units, Wood	161
CH2-W24-S07	\$ 2,462.00	D/F 24"D, To Cover Seven Units, Wood	189
CH2-W10-S08	\$ 1,324.00	S/F 10"D, To Cover Eight Units, Wood	88
CH2-W12-S08	\$ 1,493.00	S/F 12"D, To Cover Eight Units, Wood	112
CH2-W20-S08	\$ 2,536.00	D/F 20"D, To Cover Eight Units, Wood	184
CH2-W24-S08	\$ 2,691.00	D/F 24"D, To Cover Eight Units, Wood	216
CH2-W10-S09	\$ 1,478.00	S/F 10"D, To Cover Nine Units, Wood	99
CH2-W12-S09	\$ 1,673.00	S/F 12"D, To Cover Nine Units, Wood	126
CH2-W20-S09	\$ 2,867.00	D/F 20"D, To Cover Nine Units, Wood	207
CH2-W24-S09	\$ 2,988.00	D/F 24"D, To Cover Nine Units, Wood	243

**Please specify Wood Finish and Plastic Laminate. Details can be found in the Product Options section at the front of this Price List.**

**Continuous Tops for Wood Shelving (1 3/16")**  
**Epoch Collection (prices shown in Maple wood)**  
**2009 Brodart Furniture - List Prices**

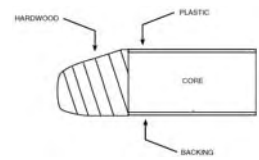

Catalog Number	List Price	Description	Weight (lbs)
<b>Edge banding on the end of tops receive mitred corners</b>			
59-W10-S01	\$ 348.00	S/F 10"D, To Cover One Unit, Wood	11
59-W12-S01	\$ 368.00	S/F 12"D, To Cover One Unit, Wood	14
59-W20-S01	\$ 602.00	D/F 20"D, To Cover One Unit, Wood	23
59-W24-S01	\$ 643.00	D/F 24"D, To Cover One Unit, Wood	27
59-W10-S02	\$ 474.00	S/F 10"D, To Cover Two Units, Wood	22
59-W12-S02	\$ 516.00	S/F 12"D, To Cover Two Units, Wood	28
59-W20-S02	\$ 849.00	D/F 20"D, To Cover Two Units, Wood	46
59-W24-S02	\$ 941.00	D/F 24"D, To Cover Two Units, Wood	54
59-W10-S03	\$ 592.00	S/F 10"D, To Cover Three Units, Wood	33
59-W12-S03	\$ 659.00	S/F 12"D, To Cover Three Units, Wood	42
59-W20-S03	\$ 1,148.00	D/F 20"D, To Cover Three Units, Wood	69
59-W24-S03	\$ 1,190.00	D/F 24"D, To Cover Three Units, Wood	81
59-W10-S04	\$ 801.00	S/F 10"D, To Cover Four Units, Wood	44
59-W12-S04	\$ 882.00	S/F 12"D, To Cover Four Units, Wood	56
59-W20-S04	\$ 1,430.00	D/F 20"D, To Cover Four Units, Wood	92
59-W24-S04	\$ 1,613.00	D/F 24"D, To Cover Four Units, Wood	108
59-W10-S05	\$ 908.00	S/F 10"D, To Cover Five Units, Wood	55
59-W12-S05	\$ 1,027.00	S/F 12"D, To Cover Five Units, Wood	70
59-W20-S05	\$ 1,730.00	D/F 20"D, To Cover Five Units, Wood	115
59-W24-S05	\$ 1,862.00	D/F 24"D, To Cover Five Units, Wood	135
59-W10-S06	\$ 1,037.00	S/F 10"D, To Cover Six Units, Wood	66
59-W12-S06	\$ 1,171.00	S/F 12"D, To Cover Six Units, Wood	84
59-W20-S06	\$ 2,032.00	D/F 20"D, To Cover Six Units, Wood	138
59-W24-S06	\$ 2,114.00	D/F 24"D, To Cover Six Units, Wood	162
59-W10-S07	\$ 1,245.00	S/F 10"D, To Cover Seven Units, Wood	77
59-W12-S07	\$ 1,394.00	S/F 12"D, To Cover Seven Units, Wood	98
59-W20-S07	\$ 2,312.00	D/F 20"D, To Cover Seven Units, Wood	161
59-W24-S07	\$ 2,536.00	D/F 24"D, To Cover Seven Units, Wood	189
59-W10-S08	\$ 1,365.00	S/F 10"D, To Cover Eight Units, Wood	88
59-W12-S08	\$ 1,539.00	S/F 12"D, To Cover Eight Units, Wood	112
59-W20-S08	\$ 2,612.00	D/F 20"D, To Cover Eight Units, Wood	184
59-W24-S08	\$ 2,773.00	D/F 24"D, To Cover Eight Units, Wood	216
59-W10-S09	\$ 1,523.00	S/F 10"D, To Cover Nine Units, Wood	99
59-W12-S09	\$ 1,722.00	S/F 12"D, To Cover Nine Units, Wood	126
59-W20-S09	\$ 2,952.00	D/F 20"D, To Cover Nine Units, Wood	207
59-W24-S09	\$ 3,077.00	D/F 24"D, To Cover Nine Units, Wood	243

**Please specify Wood Finish and Plastic Laminate. Details can be found in the Product Options section at the front of this Price List.**

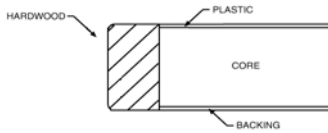

**Continuous Tops for Wood Shelving (1 3/16")**  
**Matrix Collection (prices shown in Maple wood)**  
**2009 Brodart Furniture - List Prices**

Catalog Number	List Price	Description	Weight (lbs)
93-W10-S01	\$ 270.00	S/F 10"D, To Cover One Unit, Wood	11
93-W12-S01	\$ 272.00	S/F 12"D, To Cover One Unit, Wood	14
93-W20-S01	\$ 381.00	D/F 20"D, To Cover One Unit, Wood	23
93-W24-S01	\$ 425.00	D/F 24"D, To Cover One Unit, Wood	27
93-W10-S02	\$ 356.00	S/F 10"D, To Cover Two Units, Wood	22
93-W12-S02	\$ 378.00	S/F 12"D, To Cover Two Units, Wood	28
93-W20-S02	\$ 535.00	D/F 20"D, To Cover Two Units, Wood	46
93-W24-S02	\$ 672.00	D/F 24"D, To Cover Two Units, Wood	54
93-W10-S03	\$ 465.00	S/F 10"D, To Cover Three Units, Wood	33
93-W12-S03	\$ 494.00	S/F 12"D, To Cover Three Units, Wood	42
93-W20-S03	\$ 676.00	D/F 20"D, To Cover Three Units, Wood	69
93-W24-S03	\$ 712.00	D/F 24"D, To Cover Three Units, Wood	81
93-W10-S04	\$ 710.00	S/F 10"D, To Cover Four Units, Wood	44
93-W12-S04	\$ 752.00	S/F 12"D, To Cover Four Units, Wood	56
93-W20-S04	\$ 1,057.00	D/F 20"D, To Cover Four Units, Wood	92
93-W24-S04	\$ 1,138.00	D/F 24"D, To Cover Four Units, Wood	108
93-W10-S05	\$ 819.00	S/F 10"D, To Cover Five Units, Wood	55
93-W12-S05	\$ 873.00	S/F 12"D, To Cover Five Units, Wood	70
93-W20-S05	\$ 1,212.00	D/F 20"D, To Cover Five Units, Wood	115
93-W24-S05	\$ 1,385.00	D/F 24"D, To Cover Five Units, Wood	135
93-W10-S06	\$ 927.00	S/F 10"D, To Cover Six Units, Wood	66
93-W12-S06	\$ 992.00	S/F 12"D, To Cover Six Units, Wood	84
93-W20-S06	\$ 1,349.00	D/F 20"D, To Cover Six Units, Wood	138
93-W24-S06	\$ 1,423.00	D/F 24"D, To Cover Six Units, Wood	162
93-W10-S07	\$ 1,195.00	S/F 10"D, To Cover Seven Units, Wood	77
93-W12-S07	\$ 1,267.00	S/F 12"D, To Cover Seven Units, Wood	98
93-W20-S07	\$ 1,729.00	D/F 20"D, To Cover Seven Units, Wood	161
93-W24-S07	\$ 1,848.00	D/F 24"D, To Cover Seven Units, Wood	189
93-W10-S08	\$ 1,282.00	S/F 10"D, To Cover Eight Units, Wood	88
93-W12-S08	\$ 1,368.00	S/F 12"D, To Cover Eight Units, Wood	112
93-W20-S08	\$ 1,885.00	D/F 20"D, To Cover Eight Units, Wood	184
93-W24-S08	\$ 2,095.00	D/F 24"D, To Cover Eight Units, Wood	216
93-W10-S09	\$ 1,391.00	S/F 10"D, To Cover Nine Units, Wood	99
93-W12-S09	\$ 1,486.00	S/F 12"D, To Cover Nine Units, Wood	126
93-W20-S09	\$ 2,027.00	D/F 20"D, To Cover Nine Units, Wood	207
93-W24-S09	\$ 2,132.00	D/F 24"D, To Cover Nine Units, Wood	243

**Please specify Wood Finish and Plastic Laminate. Details can be found in the Product Options section at the front of this Price List.**

**Continuous Tops for Wood Shelving (1 3/16")**  
**Quorum 94T Series (prices shown in Oak wood)**  
**2009 Brodart Furniture - List Prices**

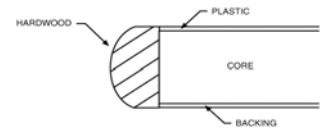

Catalog Number	List Price	Description	Weight (lbs)
94T-W10-S01	\$ 248.00	S/F 10"D, To Cover One Unit, Wood	11
94T-W12-S01	\$ 251.00	S/F 12"D, To Cover One Unit, Wood	14
94T-W20-S01	\$ 351.00	D/F 20"D, To Cover One Unit, Wood	23
94T-W24-S01	\$ 392.00	D/F 24"D, To Cover One Unit, Wood	27
94T-W10-S02	\$ 328.00	S/F 10"D, To Cover Two Units, Wood	22
94T-W12-S02	\$ 349.00	S/F 12"D, To Cover Two Units, Wood	28
94T-W20-S02	\$ 493.00	D/F 20"D, To Cover Two Units, Wood	46
94T-W24-S02	\$ 620.00	D/F 24"D, To Cover Two Units, Wood	54
94T-W10-S03	\$ 428.00	S/F 10"D, To Cover Three Units, Wood	33
94T-W12-S03	\$ 456.00	S/F 12"D, To Cover Three Units, Wood	42
94T-W20-S03	\$ 622.00	D/F 20"D, To Cover Three Units, Wood	69
94T-W24-S03	\$ 656.00	D/F 24"D, To Cover Three Units, Wood	81
94T-W10-S04	\$ 654.00	S/F 10"D, To Cover Four Units, Wood	44
94T-W12-S04	\$ 694.00	S/F 12"D, To Cover Four Units, Wood	56
94T-W20-S04	\$ 974.00	D/F 20"D, To Cover Four Units, Wood	92
94T-W24-S04	\$ 1,049.00	D/F 24"D, To Cover Four Units, Wood	108
94T-W10-S05	\$ 755.00	S/F 10"D, To Cover Five Units, Wood	55
94T-W12-S05	\$ 805.00	S/F 12"D, To Cover Five Units, Wood	70
94T-W20-S05	\$ 1,116.00	D/F 20"D, To Cover Five Units, Wood	115
94T-W24-S05	\$ 1,277.00	D/F 24"D, To Cover Five Units, Wood	135
94T-W10-S06	\$ 854.00	S/F 10"D, To Cover Six Units, Wood	66
94T-W12-S06	\$ 914.00	S/F 12"D, To Cover Six Units, Wood	84
94T-W20-S06	\$ 1,244.00	D/F 20"D, To Cover Six Units, Wood	138
94T-W24-S06	\$ 1,311.00	D/F 24"D, To Cover Six Units, Wood	162
94T-W10-S07	\$ 1,101.00	S/F 10"D, To Cover Seven Units, Wood	77
94T-W12-S07	\$ 1,167.00	S/F 12"D, To Cover Seven Units, Wood	98
94T-W20-S07	\$ 1,594.00	D/F 20"D, To Cover Seven Units, Wood	161
94T-W24-S07	\$ 1,703.00	D/F 24"D, To Cover Seven Units, Wood	189
94T-W10-S08	\$ 1,181.00	S/F 10"D, To Cover Eight Units, Wood	88
94T-W12-S08	\$ 1,262.00	S/F 12"D, To Cover Eight Units, Wood	112
94T-W20-S08	\$ 1,738.00	D/F 20"D, To Cover Eight Units, Wood	184
94T-W24-S08	\$ 1,931.00	D/F 24"D, To Cover Eight Units, Wood	216
94T-W10-S09	\$ 1,282.00	S/F 10"D, To Cover Nine Units, Wood	99
94T-W12-S09	\$ 1,370.00	S/F 12"D, To Cover Nine Units, Wood	126
94T-W20-S09	\$ 1,867.00	D/F 20"D, To Cover Nine Units, Wood	207
94T-W24-S09	\$ 1,966.00	D/F 24"D, To Cover Nine Units, Wood	243

**Please specify Wood Finish and Plastic Laminate. Details can be found in the Product Options section at the front of this Price List.**



**Continuous Tops for Wood Shelving (1 3/16")  
Modifications for Continuous Tops  
2009 Brodart Furniture - List Prices**

Catalog Number	List Price	Description	Weight (lbs)
----------------	------------	-------------	--------------

---

**Change Standard HPL to Marmoleum**

32% Per Top

**Change Standard Top/Edge Band to Corian**

Please Call for Pricing

**Continuous Tops for Steel Shelving (1 3/16")**  
**64 Series - Internal Edge Band (prices shown in Oak wood)**  
**2009 Brodart Furniture - List Prices**

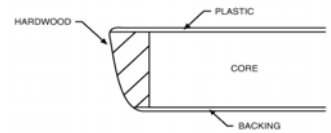

Catalog Number	List Price	Description	Weight (lbs)
64-S10-S01	\$ 236.00	S/F 10"D, To Cover One Unit, Steel	11
64-S12-S01	\$ 242.00	S/F 12"D, To Cover One Unit, Steel	14
64-S20-S01	\$ 339.00	D/F 20"D, To Cover One Unit, Steel	23
64-S24-S01	\$ 383.00	D/F 24"D, To Cover One Unit, Steel	27
64-S10-S02	\$ 318.00	S/F 10"D, To Cover Two Units, Steel	22
64-S12-S02	\$ 336.00	S/F 12"D, To Cover Two Units, Steel	28
64-S20-S02	\$ 480.00	D/F 20"D, To Cover Two Units, Steel	46
64-S24-S02	\$ 603.00	D/F 24"D, To Cover Two Units, Steel	54
64-S10-S03	\$ 412.00	S/F 10"D, To Cover Three Units, Steel	33
64-S12-S03	\$ 444.00	S/F 12"D, To Cover Three Units, Steel	42
64-S20-S03	\$ 605.00	D/F 20"D, To Cover Three Units, Steel	69
64-S24-S03	\$ 637.00	D/F 24"D, To Cover Three Units, Steel	81
64-S10-S04	\$ 642.00	S/F 10"D, To Cover Four Units, Steel	44
64-S12-S04	\$ 673.00	S/F 12"D, To Cover Four Units, Steel	56
64-S20-S04	\$ 943.00	D/F 20"D, To Cover Four Units, Steel	92
64-S24-S04	\$ 1,018.00	D/F 24"D, To Cover Four Units, Steel	108
64-S10-S05	\$ 733.00	S/F 10"D, To Cover Five Units, Steel	55
64-S12-S05	\$ 780.00	S/F 12"D, To Cover Five Units, Steel	70
64-S20-S05	\$ 1,083.00	D/F 20"D, To Cover Five Units, Steel	115
64-S24-S05	\$ 1,241.00	D/F 24"D, To Cover Five Units, Steel	135
64-S10-S06	\$ 830.00	S/F 10"D, To Cover Six Units, Steel	66
64-S12-S06	\$ 890.00	S/F 12"D, To Cover Six Units, Steel	84
64-S20-S06	\$ 1,208.00	D/F 20"D, To Cover Six Units, Steel	138
64-S24-S06	\$ 1,276.00	D/F 24"D, To Cover Six Units, Steel	162
64-S10-S07	\$ 1,057.00	S/F 10"D, To Cover Seven Units, Steel	77
64-S12-S07	\$ 1,119.00	S/F 12"D, To Cover Seven Units, Steel	98
64-S20-S07	\$ 1,548.00	D/F 20"D, To Cover Seven Units, Steel	161
64-S24-S07	\$ 1,624.00	D/F 24"D, To Cover Seven Units, Steel	189
64-S10-S08	\$ 1,146.00	S/F 10"D, To Cover Eight Units, Steel	88
64-S12-S08	\$ 1,228.00	S/F 12"D, To Cover Eight Units, Steel	112
64-S20-S08	\$ 1,688.00	D/F 20"D, To Cover Eight Units, Steel	184
64-S24-S08	\$ 1,879.00	D/F 24"D, To Cover Eight Units, Steel	216
64-S10-S09	\$ 1,244.00	S/F 10"D, To Cover Nine Units, Steel	99
64-S12-S09	\$ 1,334.00	S/F 12"D, To Cover Nine Units, Steel	126
64-S20-S09	\$ 1,810.00	D/F 20"D, To Cover Nine Units, Steel	207
64-S24-S09	\$ 1,910.00	D/F 24"D, To Cover Nine Units, Steel	243

**Note:** Add 15% for HPL on top & bottom (Steel Shelving Only)

**Please specify Wood Finish and Plastic Laminate. Details can be found in the Product Options section at the front of this Price List.**

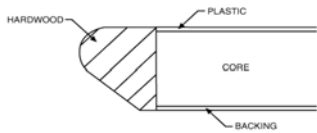

**Continuous Tops for Steel Shelving (1 3/16")**  
**Chancellor Collection (prices shown in Oak wood)**  
**2009 Brodart Furniture - List Prices**

Catalog Number	List Price	Description	Weight (lbs)
<b>Edge Band on long side only. Tops are designed to be "pinched" between end panels</b>			
CH2-S10-S01	\$ 187.00	S/F 10"D, To Cover One Unit, Steel	11
CH2-S12-S01	\$ 207.00	S/F 12"D, To Cover One Unit, Steel	14
CH2-S20-S01	\$ 318.00	D/F 20"D, To Cover One Unit, Steel	23
CH2-S24-S01	\$ 358.00	D/F 24"D, To Cover One Unit, Steel	27
CH2-S10-S02	\$ 311.00	S/F 10"D, To Cover Two Units, Steel	22
CH2-S12-S02	\$ 350.00	S/F 12"D, To Cover Two Units, Steel	28
CH2-S20-S02	\$ 558.00	D/F 20"D, To Cover Two Units, Steel	46
CH2-S24-S02	\$ 647.00	D/F 24"D, To Cover Two Units, Steel	54
CH2-S10-S03	\$ 425.00	S/F 10"D, To Cover Three Units, Steel	33
CH2-S12-S03	\$ 490.00	S/F 12"D, To Cover Three Units, Steel	42
CH2-S20-S03	\$ 848.00	D/F 20"D, To Cover Three Units, Steel	69
CH2-S24-S03	\$ 889.00	D/F 24"D, To Cover Three Units, Steel	81
CH2-S10-S04	\$ 628.00	S/F 10"D, To Cover Four Units, Steel	44
CH2-S12-S04	\$ 707.00	S/F 12"D, To Cover Four Units, Steel	56
CH2-S20-S04	\$ 1,122.00	D/F 20"D, To Cover Four Units, Steel	92
CH2-S24-S04	\$ 1,298.00	D/F 24"D, To Cover Four Units, Steel	108
CH2-S10-S05	\$ 732.00	S/F 10"D, To Cover Five Units, Steel	55
CH2-S12-S05	\$ 847.00	S/F 12"D, To Cover Five Units, Steel	70
CH2-S20-S05	\$ 1,413.00	D/F 20"D, To Cover Five Units, Steel	115
CH2-S24-S05	\$ 1,540.00	D/F 24"D, To Cover Five Units, Steel	135
CH2-S10-S06	\$ 858.00	S/F 10"D, To Cover Six Units, Steel	66
CH2-S12-S06	\$ 988.00	S/F 12"D, To Cover Six Units, Steel	84
CH2-S20-S06	\$ 1,706.00	D/F 20"D, To Cover Six Units, Steel	138
CH2-S24-S06	\$ 1,786.00	D/F 24"D, To Cover Six Units, Steel	162
CH2-S10-S07	\$ 1,059.00	S/F 10"D, To Cover Seven Units, Steel	77
CH2-S12-S07	\$ 1,203.00	S/F 12"D, To Cover Seven Units, Steel	98
CH2-S20-S07	\$ 1,977.00	D/F 20"D, To Cover Seven Units, Steel	161
CH2-S24-S07	\$ 2,195.00	D/F 24"D, To Cover Seven Units, Steel	189
CH2-S10-S08	\$ 1,175.00	S/F 10"D, To Cover Eight Units, Steel	88
CH2-S12-S08	\$ 1,344.00	S/F 12"D, To Cover Eight Units, Steel	112
CH2-S20-S08	\$ 2,270.00	D/F 20"D, To Cover Eight Units, Steel	184
CH2-S24-S08	\$ 2,425.00	D/F 24"D, To Cover Eight Units, Steel	216
CH2-S10-S09	\$ 1,328.00	S/F 10"D, To Cover Nine Units, Steel	99
CH2-S12-S09	\$ 1,523.00	S/F 12"D, To Cover Nine Units, Steel	126
CH2-S20-S09	\$ 2,599.00	D/F 20"D, To Cover Nine Units, Steel	207
CH2-S24-S09	\$ 2,720.00	D/F 24"D, To Cover Nine Units, Steel	243

**Note:** Add 15% for HPL on top & bottom (Steel Shelving Only)

**Please specify Wood Finish and Plastic Laminate. Details can be found in the Product Options section at the front of this Price List.**

**Continuous Tops for Steel Shelving (1 3/16")**  
**Epoch Collection (prices shown in Maple wood)**  
**2009 Brodart Furniture - List Prices**

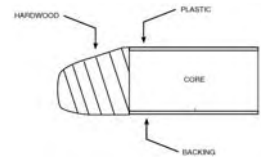

Catalog Number	List Price	Description	Weight (lbs)
<b>Edge Band on long side only. Tops are designed to be "pinched" between end panels</b>			
59-S10-S01	\$ 192.00	S/F 10"D, To Cover One Unit, Steel	11
59-S12-S01	\$ 213.00	S/F 12"D, To Cover One Unit, Steel	14
59-S20-S01	\$ 328.00	D/F 20"D, To Cover One Unit, Steel	23
59-S24-S01	\$ 368.00	D/F 24"D, To Cover One Unit, Steel	27
59-S10-S02	\$ 326.00	S/F 10"D, To Cover Two Units, Steel	22
59-S12-S02	\$ 365.00	S/F 12"D, To Cover Two Units, Steel	28
59-S20-S02	\$ 587.00	D/F 20"D, To Cover Two Units, Steel	46
59-S24-S02	\$ 676.00	D/F 24"D, To Cover Two Units, Steel	54
59-S10-S03	\$ 454.00	S/F 10"D, To Cover Three Units, Steel	33
59-S12-S03	\$ 519.00	S/F 12"D, To Cover Three Units, Steel	42
59-S20-S03	\$ 908.00	D/F 20"D, To Cover Three Units, Steel	69
59-S24-S03	\$ 947.00	D/F 24"D, To Cover Three Units, Steel	81
59-S10-S04	\$ 657.00	S/F 10"D, To Cover Four Units, Steel	44
59-S12-S04	\$ 736.00	S/F 12"D, To Cover Four Units, Steel	56
59-S20-S04	\$ 1,181.00	D/F 20"D, To Cover Four Units, Steel	92
59-S24-S04	\$ 1,358.00	D/F 24"D, To Cover Four Units, Steel	108
59-S10-S05	\$ 777.00	S/F 10"D, To Cover Five Units, Steel	55
59-S12-S05	\$ 891.00	S/F 12"D, To Cover Five Units, Steel	70
59-S20-S05	\$ 1,502.00	D/F 20"D, To Cover Five Units, Steel	115
59-S24-S05	\$ 1,629.00	D/F 24"D, To Cover Five Units, Steel	135
59-S10-S06	\$ 917.00	S/F 10"D, To Cover Six Units, Steel	66
59-S12-S06	\$ 1,046.00	S/F 12"D, To Cover Six Units, Steel	84
59-S20-S06	\$ 1,824.00	D/F 20"D, To Cover Six Units, Steel	138
59-S24-S06	\$ 1,904.00	D/F 24"D, To Cover Six Units, Steel	162
59-S10-S07	\$ 1,118.00	S/F 10"D, To Cover Seven Units, Steel	77
59-S12-S07	\$ 1,263.00	S/F 12"D, To Cover Seven Units, Steel	98
59-S20-S07	\$ 2,095.00	D/F 20"D, To Cover Seven Units, Steel	161
59-S24-S07	\$ 2,313.00	D/F 24"D, To Cover Seven Units, Steel	189
59-S10-S08	\$ 1,249.00	S/F 10"D, To Cover Eight Units, Steel	88
59-S12-S08	\$ 1,418.00	S/F 12"D, To Cover Eight Units, Steel	112
59-S20-S08	\$ 2,417.00	D/F 20"D, To Cover Eight Units, Steel	184
59-S24-S08	\$ 2,573.00	D/F 24"D, To Cover Eight Units, Steel	216
59-S10-S09	\$ 1,417.00	S/F 10"D, To Cover Nine Units, Steel	99
59-S12-S09	\$ 1,612.00	S/F 12"D, To Cover Nine Units, Steel	126
59-S20-S09	\$ 2,776.00	D/F 20"D, To Cover Nine Units, Steel	207
59-S24-S09	\$ 2,897.00	D/F 24"D, To Cover Nine Units, Steel	243

**Note:** Add 15% for HPL on top & bottom (Steel Shelving Only)

**Please specify Wood Finish and Plastic Laminate. Details can be found in the Product Options section at the front of this Price List.**

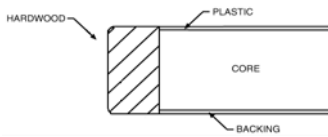

**Continuous Tops for Steel Shelving (1 3/16")**  
**Matrix Collection (prices shown in Maple wood)**  
**2009 Brodart Furniture - List Prices**

Catalog Number	List Price	Description	Weight (lbs)
93-S10-S01	\$ 293.00	S/F 10"D, To Cover One Unit, Steel	11
93-S12-S01	\$ 295.00	S/F 12"D, To Cover One Unit, Steel	14
93-S20-S01	\$ 412.00	D/F 20"D, To Cover One Unit, Steel	23
93-S24-S01	\$ 465.00	D/F 24"D, To Cover One Unit, Steel	27
93-S10-S02	\$ 384.00	S/F 10"D, To Cover Two Units, Steel	22
93-S12-S02	\$ 409.00	S/F 12"D, To Cover Two Units, Steel	28
93-S20-S02	\$ 582.00	D/F 20"D, To Cover Two Units, Steel	46
93-S24-S02	\$ 729.00	D/F 24"D, To Cover Two Units, Steel	54
93-S10-S03	\$ 503.00	S/F 10"D, To Cover Three Units, Steel	33
93-S12-S03	\$ 538.00	S/F 12"D, To Cover Three Units, Steel	42
93-S20-S03	\$ 733.00	D/F 20"D, To Cover Three Units, Steel	69
93-S24-S03	\$ 770.00	D/F 24"D, To Cover Three Units, Steel	81
93-S10-S04	\$ 774.00	S/F 10"D, To Cover Four Units, Steel	44
93-S12-S04	\$ 819.00	S/F 12"D, To Cover Four Units, Steel	56
93-S20-S04	\$ 1,094.00	D/F 20"D, To Cover Four Units, Steel	92
93-S24-S04	\$ 1,236.00	D/F 24"D, To Cover Four Units, Steel	108
93-S10-S05	\$ 885.00	S/F 10"D, To Cover Five Units, Steel	55
93-S12-S05	\$ 948.00	S/F 12"D, To Cover Five Units, Steel	70
93-S20-S05	\$ 1,315.00	D/F 20"D, To Cover Five Units, Steel	115
93-S24-S05	\$ 1,505.00	D/F 24"D, To Cover Five Units, Steel	135
93-S10-S06	\$ 1,004.00	S/F 10"D, To Cover Six Units, Steel	66
93-S12-S06	\$ 1,080.00	S/F 12"D, To Cover Six Units, Steel	84
93-S20-S06	\$ 1,465.00	D/F 20"D, To Cover Six Units, Steel	138
93-S24-S06	\$ 1,544.00	D/F 24"D, To Cover Six Units, Steel	162
93-S10-S07	\$ 1,274.00	S/F 10"D, To Cover Seven Units, Steel	77
93-S12-S07	\$ 1,360.00	S/F 12"D, To Cover Seven Units, Steel	98
93-S20-S07	\$ 1,894.00	D/F 20"D, To Cover Seven Units, Steel	161
93-S24-S07	\$ 2,009.00	D/F 24"D, To Cover Seven Units, Steel	189
93-S10-S08	\$ 1,391.00	S/F 10"D, To Cover Eight Units, Steel	88
93-S12-S08	\$ 1,486.00	S/F 12"D, To Cover Eight Units, Steel	112
93-S20-S08	\$ 2,047.00	D/F 20"D, To Cover Eight Units, Steel	184
93-S24-S08	\$ 2,275.00	D/F 24"D, To Cover Eight Units, Steel	216
93-S10-S09	\$ 1,509.00	S/F 10"D, To Cover Nine Units, Steel	99
93-S12-S09	\$ 1,619.00	S/F 12"D, To Cover Nine Units, Steel	126
93-S20-S09	\$ 2,198.00	D/F 20"D, To Cover Nine Units, Steel	207
93-S24-S09	\$ 2,318.00	D/F 24"D, To Cover Nine Units, Steel	243

**Note:** Add 15% for HPL on top & bottom (Steel Shelving Only)

**Please specify Wood Finish and Plastic Laminate. Details can be found in the Product Options section at the front of this Price List.**

**Continuous Tops for Steel Shelving (1 3/16")**  
**Quorum 94T Series (prices shown in Oak wood)**  
**2009 Brodart Furniture - List Prices**

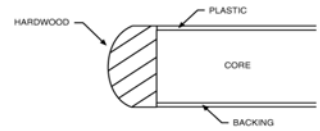

Catalog Number	List Price	Description	Weight (lbs)
94T-S10-S01	\$ 270.00	S/F 10"D, To Cover One Unit, Steel	11
94T-S12-S01	\$ 272.00	S/F 12"D, To Cover One Unit, Steel	14
94T-S20-S01	\$ 381.00	D/F 20"D, To Cover One Unit, Steel	23
94T-S24-S01	\$ 428.00	D/F 24"D, To Cover One Unit, Steel	27
94T-S10-S02	\$ 354.00	S/F 10"D, To Cover Two Units, Steel	22
94T-S12-S02	\$ 377.00	S/F 12"D, To Cover Two Units, Steel	28
94T-S20-S02	\$ 536.00	D/F 20"D, To Cover Two Units, Steel	46
94T-S24-S02	\$ 672.00	D/F 24"D, To Cover Two Units, Steel	54
94T-S10-S03	\$ 463.00	S/F 10"D, To Cover Three Units, Steel	33
94T-S12-S03	\$ 496.00	S/F 12"D, To Cover Three Units, Steel	42
94T-S20-S03	\$ 676.00	D/F 20"D, To Cover Three Units, Steel	69
94T-S24-S03	\$ 710.00	D/F 24"D, To Cover Three Units, Steel	81
94T-S10-S04	\$ 713.00	S/F 10"D, To Cover Four Units, Steel	44
94T-S12-S04	\$ 755.00	S/F 12"D, To Cover Four Units, Steel	56
94T-S20-S04	\$ 1,008.00	D/F 20"D, To Cover Four Units, Steel	92
94T-S24-S04	\$ 1,139.00	D/F 24"D, To Cover Four Units, Steel	108
94T-S10-S05	\$ 816.00	S/F 10"D, To Cover Five Units, Steel	55
94T-S12-S05	\$ 875.00	S/F 12"D, To Cover Five Units, Steel	70
94T-S20-S05	\$ 1,212.00	D/F 20"D, To Cover Five Units, Steel	115
94T-S24-S05	\$ 1,386.00	D/F 24"D, To Cover Five Units, Steel	135
94T-S10-S06	\$ 925.00	S/F 10"D, To Cover Six Units, Steel	66
94T-S12-S06	\$ 995.00	S/F 12"D, To Cover Six Units, Steel	84
94T-S20-S06	\$ 1,351.00	D/F 20"D, To Cover Six Units, Steel	138
94T-S24-S06	\$ 1,423.00	D/F 24"D, To Cover Six Units, Steel	162
94T-S10-S07	\$ 1,175.00	S/F 10"D, To Cover Seven Units, Steel	77
94T-S12-S07	\$ 1,253.00	S/F 12"D, To Cover Seven Units, Steel	98
94T-S20-S07	\$ 1,745.00	D/F 20"D, To Cover Seven Units, Steel	161
94T-S24-S07	\$ 1,851.00	D/F 24"D, To Cover Seven Units, Steel	189
94T-S10-S08	\$ 1,282.00	S/F 10"D, To Cover Eight Units, Steel	88
94T-S12-S08	\$ 1,370.00	S/F 12"D, To Cover Eight Units, Steel	112
94T-S20-S08	\$ 1,887.00	D/F 20"D, To Cover Eight Units, Steel	184
94T-S24-S08	\$ 2,097.00	D/F 24"D, To Cover Eight Units, Steel	216
94T-S10-S09	\$ 1,390.00	S/F 10"D, To Cover Nine Units, Steel	99
94T-S12-S09	\$ 1,492.00	S/F 12"D, To Cover Nine Units, Steel	126
94T-S20-S09	\$ 2,027.00	D/F 20"D, To Cover Nine Units, Steel	207
94T-S24-S09	\$ 2,136.00	D/F 24"D, To Cover Nine Units, Steel	243

**Note:** Add 15% for HPL on top & bottom (Steel Shelving Only)

**Please specify Wood Finish and Plastic Laminate. Details can be found in the Product Options section at the front of this Price List.**

**Continuous Tops for Steel Shelving (1 3/16")  
Modifications for Continuous Tops  
2009 Brodart Furniture - List Prices**

Catalog Number	List Price	Description	Weight (lbs)
----------------	------------	-------------	--------------

---

**Add HPL to Top and Bottom of Shelving Top (Steel Shelving ONLY)**

15% Per Top

**Change Standard HPL to Marmoleum**

32% Per Top

**Change Standard Top/Edge Band to Corian**

Please Call for Pricing

**End Panels for Steel Shelving**  
**Berwyn Collection (prices shown in Cherry wood)**  
**2009 Brodart Furniture - List Prices**

**Note: End Panels are not machined. No fastening hardware is provided with End Panels**

Catalog Number	List Price	Description	Weight (lbs)
----------------	------------	-------------	--------------

**End Panels for Steel Shelving w/o Continuous Tops**

**Single Faced**

66-702-S00	\$ 1,027.00	S/F End Panel, 12 1/4" x 42 1/2" H
66-703-S00	\$ 1,106.00	S/F End Panel, 14 1/4" x 42 1/2" H
66-705-S00	\$ 1,293.00	S/F End Panel, 12 1/4" x 66 1/2" H
66-706-S00	\$ 1,401.00	S/F End Panel, 14 1/4" x 66 1/2" H
66-708-S00	\$ 1,380.00	S/F End Panel, 12 1/4" x 78 1/2" H
66-709-S00	\$ 1,509.00	S/F End Panel, 14 1/4" x 78 1/2" H
66-711-S00	\$ 1,717.00	S/F End Panel, 12 1/4" x 84 1/2" H
66-712-S00	\$ 1,854.00	S/F End Panel, 14 1/4" x 84 1/2" H
66-714-S00	\$ 1,739.00	S/F End Panel, 12 1/4" x 90 1/2" H
66-715-S00	\$ 1,882.00	S/F End Panel, 14 1/4" x 90 1/2" H

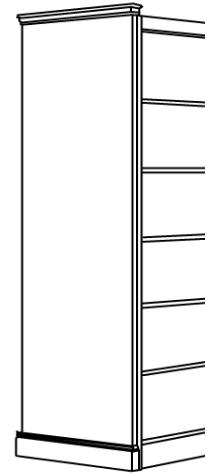

13  
16  
20  
24  
24  
29  
26  
31  
28  
33

**Double Faced**

66-722-S00	\$ 1,832.00	D/F End Panel, 21" x 42 1/2" H
66-723-S00	\$ 1,908.00	D/F End Panel, 25" x 42 1/2" H
66-725-S00	\$ 1,977.00	D/F End Panel, 21" x 66 1/2" H
66-726-S00	\$ 2,055.00	D/F End Panel, 25" x 66 1/2" H
66-728-S00	\$ 2,012.00	D/F End Panel, 21" x 78 1/2" H
66-729-S00	\$ 2,263.00	D/F End Panel, 25" x 78 1/2" H
66-731-S00	\$ 2,393.00	D/F End Panel, 21" x 84 1/2" H
66-732-S00	\$ 2,644.00	D/F End Panel, 25" x 84 1/2" H
66-734-S00	\$ 2,457.00	D/F End Panel, 21" x 90 1/2" H
66-735-S00	\$ 2,773.00	D/F End Panel, 25" x 90 1/2" H



25  
31  
41  
49  
48  
58  
52  
62  
56  
67

**Note: Heights noted do NOT include the top cap**

**Please specify Wood Finish. Details can be found in the Product Options section at the front of this Price List.**



**End Panels for Steel Shelving**  
**Berwyn Collection (prices shown in Cherry wood)**  
**2009 Brodart Furniture - List Prices**

**Note: End Panels are not machined. No fastening hardware is provided with End Panels**

Catalog Number	List Price	Description	Weight (lbs)
----------------	------------	-------------	--------------

**End Panels for Steel Shelving w/Continuous Tops**

**Single Faced**

66-702-S02	\$ 1,027.00	S/F End Panel, 13 7/8" x 43 3/4" H
66-703-S02	\$ 1,106.00	S/F End Panel, 15 7/8" x 43 3/4" H
66-705-S02	\$ 1,293.00	S/F End Panel, 13 7/8" x 67 3/4" H
66-706-S02	\$ 1,401.00	S/F End Panel, 15 7/8" x 67 3/4" H
66-708-S02	\$ 1,380.00	S/F End Panel, 13 7/8" x 79 3/4" H
66-709-S02	\$ 1,509.00	S/F End Panel, 15 7/8" x 79 3/4" H
66-711-S02	\$ 1,717.00	S/F End Panel, 13 7/8" x 85 3/4" H
66-712-S02	\$ 1,854.00	S/F End Panel, 15 7/8" x 85 3/4" H
66-714-S02	\$ 1,739.00	S/F End Panel, 13 7/8" x 91 3/4" H
66-715-S02	\$ 1,882.00	S/F End Panel, 15 7/8" x 91 3/4" H



13  
16  
20  
24  
24  
29  
26  
31  
28  
33

**Double Faced**

66-722-S02	\$ 1,832.00	D/F End Panel, 24 3/8" x 43 3/4" H
66-723-S02	\$ 1,908.00	D/F End Panel, 28 3/8" x 43 3/4" H
66-725-S02	\$ 1,977.00	D/F End Panel, 24 3/8" x 67 3/4" H
66-726-S02	\$ 2,055.00	D/F End Panel, 28 3/8" x 67 3/4" H
66-728-S02	\$ 2,012.00	D/F End Panel, 24 3/8" x 79 3/4" H
66-729-S02	\$ 2,263.00	D/F End Panel, 28 3/8" x 79 3/4" H
66-731-S02	\$ 2,393.00	D/F End Panel, 24 3/8" x 85 3/4" H
66-732-S02	\$ 2,644.00	D/F End Panel, 28 3/8" x 85 3/4" H
66-734-S02	\$ 2,457.00	D/F End Panel, 24 3/8" x 91 3/4" H
66-735-S02	\$ 2,773.00	D/F End Panel, 28 3/8" x 91 3/4" H

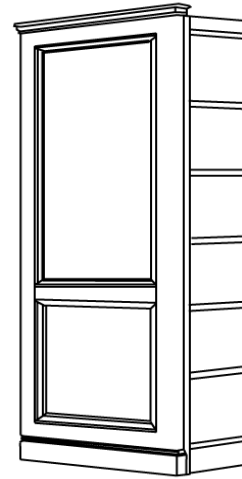

25  
31  
41  
49  
48  
58  
52  
62  
56  
67

**Note: Heights noted do NOT include the top cap**

**Please specify Wood Finish. Details can be found in the Product Options section at the front of this Price List.**

**End Panels for Steel Shelving**  
**Chancellor's Collection (prices shown in Oak wood)**  
**2009 Brodart Furniture - List Prices**

**Note: End Panels are not machined. No fastening hardware is provided with End Panels**

Catalog Number	List Price	Description	Weight (lbs)
----------------	------------	-------------	--------------

**End Panels for Steel Shelving w/o Continuous Tops**

**Single Faced (not offered w/ sketch face)**

CH2-702-S00	\$ 567.00	S/F End Panel, 12 1/4" x 42 1/2" H	13
CH2-703-S00	\$ 587.00	S/F End Panel, 14 1/4" x 42 1/2" H	16
CH2-705-S00	\$ 649.00	S/F End Panel, 12 1/4" x 66 1/2" H	20
CH2-706-S00	\$ 678.00	S/F End Panel, 14 1/4" x 66 1/2" H	24
CH2-708-S00	\$ 704.00	S/F End Panel, 12 1/4" x 78 1/2" H	24
CH2-709-S00	\$ 737.00	S/F End Panel, 14 1/4" x 78 1/2" H	29
CH2-711-S00	\$ 730.00	S/F End Panel, 12 1/4" x 84 1/2" H	26
CH2-712-S00	\$ 776.00	S/F End Panel, 14 1/4" x 84 1/2" H	31
CH2-714-S00	\$ 763.00	S/F End Panel, 12 1/4" x 90 1/2" H	28
CH2-715-S00	\$ 806.00	S/F End Panel, 14 1/4" x 90 1/2" H	33



**Double Faced**

CH2-722-S00	\$ 711.00	D/F End Panel, 21" x 42 1/2" H	25
CH2-723-S00	\$ 739.00	D/F End Panel, 25" x 42 1/2" H	31
CH2-725-S00	\$ 848.00	D/F End Panel, 21" x 66 1/2" H	41
CH2-726-S00	\$ 913.00	D/F End Panel, 25" x 66 1/2" H	49
CH2-728-S00	\$ 932.00	D/F End Panel, 21" x 78 1/2" H	48
CH2-729-S00	\$ 1,011.00	D/F End Panel, 25" x 78 1/2" H	58
CH2-731-S00	\$ 974.00	D/F End Panel, 21" x 84 1/2" H	52
CH2-732-S00	\$ 1,063.00	D/F End Panel, 25" x 84 1/2" H	62
CH2-734-S00	\$ 1,021.00	D/F End Panel, 21" x 90 1/2" H	56
CH2-735-S00	\$ 1,112.00	D/F End Panel, 25" x 90 1/2" H	67

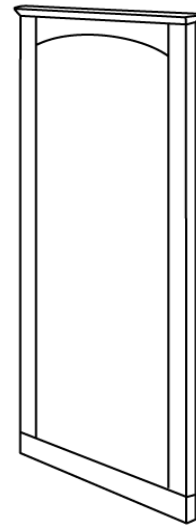

**Note: Heights noted do NOT include the top cap**

**Please specify Wood Finish. Details can be found in the Product Options section at the front of this Price List.**

**End Panels for Steel Shelving**  
**Chancellor's Collection (prices shown in Oak wood)**  
**2009 Brodart Furniture - List Prices**

**Note: End Panels are not machined. No fastening hardware is provided with End Panels**

Catalog Number	List Price	Description	Weight (lbs)
----------------	------------	-------------	--------------

**End Panels for Steel Shelving w/Continuous Tops**

**Single Faced (not offered w/ sketch face)**

CH2-702-S02	\$ 567.00	S/F End Panel, 13 7/8" x 43 3/4" H	13
CH2-703-S02	\$ 587.00	S/F End Panel, 15 7/8" x 43 3/4" H	16
CH2-705-S02	\$ 649.00	S/F End Panel, 13 7/8" x 67 3/4" H	20
CH2-706-S02	\$ 678.00	S/F End Panel, 15 7/8" x 67 3/4" H	24
CH2-708-S02	\$ 704.00	S/F End Panel, 13 7/8" x 79 3/4" H	24
CH2-709-S02	\$ 737.00	S/F End Panel, 15 7/8" x 79 3/4" H	29
CH2-711-S02	\$ 730.00	S/F End Panel, 13 7/8" x 85 3/4" H	26
CH2-712-S02	\$ 776.00	S/F End Panel, 15 7/8" x 85 3/4" H	31
CH2-714-S02	\$ 763.00	S/F End Panel, 13 7/8" x 91 3/4" H	28
CH2-715-S02	\$ 806.00	S/F End Panel, 15 7/8" x 91 3/4" H	33



**Double Faced**

CH2-722-S02	\$ 711.00	D/F End Panel, 24 3/8" x 43 3/4" H	25
CH2-723-S02	\$ 739.00	D/F End Panel, 28 3/8" x 43 3/4" H	31
CH2-725-S02	\$ 848.00	D/F End Panel, 24 3/8" x 67 3/4" H	41
CH2-726-S02	\$ 913.00	D/F End Panel, 28 3/8" x 67 3/4" H	49
CH2-728-S02	\$ 932.00	D/F End Panel, 24 3/8" x 79 3/4" H	48
CH2-729-S02	\$ 1,011.00	D/F End Panel, 28 3/8" x 79 3/4" H	58
CH2-731-S02	\$ 974.00	D/F End Panel, 24 3/8" x 85 3/4" H	52
CH2-732-S02	\$ 1,063.00	D/F End Panel, 28 3/8" x 85 3/4" H	62
CH2-734-S02	\$ 1,021.00	D/F End Panel, 24 3/8" x 91 3/4" H	56
CH2-735-S02	\$ 1,112.00	D/F End Panel, 28 3/8" x 91 3/4" H	67

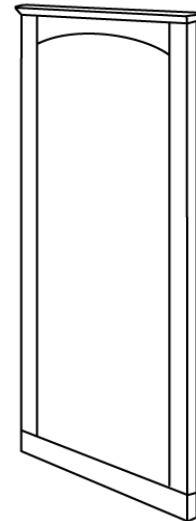

**Note: Heights noted do NOT include the top cap**

**Please specify Wood Finish. Details can be found in the Product Options section at the front of this Price List.**

**End Panels for Steel Shelving**  
**Epoch Collection (prices shown in Maple wood)**  
**2009 Brodart Furniture - List Prices**

**Note: End Panels are not machined. No fastening hardware is provided with End Panels**

Catalog Number	List Price	Description	Weight (lbs)
----------------	------------	-------------	--------------

**End Panels for Steel Shelving w/o Continuous Tops**

**Single Faced**

59-702-S00	\$ 383.00	S/F End Panel, 12 1/4" x 42 1/2" H	13
59-703-S00	\$ 401.00	S/F End Panel, 14 1/4" x 42 1/2" H	16
59-705-S00	\$ 488.00	S/F End Panel, 12 1/4" x 66 1/2" H	20
59-706-S00	\$ 507.00	S/F End Panel, 14 1/4" x 66 1/2" H	24
59-708-S00	\$ 513.00	S/F End Panel, 12 1/4" x 78 1/2" H	24
59-709-S00	\$ 534.00	S/F End Panel, 14 1/4" x 78 1/2" H	29
59-711-S00	\$ 538.00	S/F End Panel, 12 1/4" x 84 1/2" H	26
59-712-S00	\$ 559.00	S/F End Panel, 14 1/4" x 84 1/2" H	31
59-714-S00	\$ 563.00	S/F End Panel, 12 1/4" x 90 1/2" H	28
59-715-S00	\$ 584.00	S/F End Panel, 14 1/4" x 90 1/2" H	33



**Double Faced**

59-722-S00	\$ 799.00	D/F End Panel, 21" x 42 1/2" H	25
59-723-S00	\$ 828.00	D/F End Panel, 25" x 42 1/2" H	31
59-725-S00	\$ 987.00	D/F End Panel, 21" x 66 1/2" H	41
59-726-S00	\$ 1,023.00	D/F End Panel, 25" x 66 1/2" H	49
59-728-S00	\$ 1,013.00	D/F End Panel, 21" x 78 1/2" H	48
59-729-S00	\$ 1,053.00	D/F End Panel, 25" x 78 1/2" H	58
59-731-S00	\$ 1,038.00	D/F End Panel, 21" x 84 1/2" H	52
59-732-S00	\$ 1,077.00	D/F End Panel, 25" x 84 1/2" H	62
59-734-S00	\$ 1,080.00	D/F End Panel, 21" x 90 1/2" H	56
59-735-S00	\$ 1,122.00	D/F End Panel, 25" x 90 1/2" H	67



**Note: Heights noted are to the bottom of the curve on the top of the panel**

**Please specify Wood Finish, Metal and Glass (if applicable). Details can be found in the Product Options section at the front of this Price List.**

**End Panels for Steel Shelving**  
**Epoch Collection (prices shown in Maple wood)**  
**2009 Brodart Furniture - List Prices**

**Note: End Panels are not machined. No fastening hardware is provided with End Panels**

Catalog Number	List Price	Description	Weight (lbs)
----------------	------------	-------------	--------------

**End Panels for Steel Shelving w/Continuous Tops**

**Single Faced**

59-702-S02	\$ 383.00	S/F End Panel, 13 7/8" x 43 3/4" H	13
59-703-S02	\$ 401.00	S/F End Panel, 15 7/8" x 43 3/4" H	16
59-705-S02	\$ 488.00	S/F End Panel, 13 7/8" x 67 3/4" H	20
59-706-S02	\$ 507.00	S/F End Panel, 15 7/8" x 67 3/4" H	24
59-708-S02	\$ 513.00	S/F End Panel, 13 7/8" x 79 3/4" H	24
59-709-S02	\$ 534.00	S/F End Panel, 15 7/8" x 79 3/4" H	29
59-711-S02	\$ 538.00	S/F End Panel, 13 7/8" x 85 3/4" H	26
59-712-S02	\$ 559.00	S/F End Panel, 15 7/8" x 85 3/4" H	31
59-714-S02	\$ 563.00	S/F End Panel, 13 7/8" x 91 3/4" H	28
59-715-S02	\$ 584.00	S/F End Panel, 15 7/8" x 91 3/4" H	33

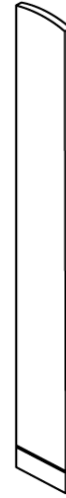

**Double Face**

59-722-S02	\$ 799.00	D/F End Panel, 24 3/8" x 43 3/4" H	25
59-723-S02	\$ 828.00	D/F End Panel, 28 3/8" x 43 3/4" H	31
59-725-S02	\$ 987.00	D/F End Panel, 24 3/8" x 67 3/4" H	41
59-726-S02	\$ 1,023.00	D/F End Panel, 28 3/8" x 67 3/4" H	49
59-728-S02	\$ 1,013.00	D/F End Panel, 24 3/8" x 79 3/4" H	48
59-729-S02	\$ 1,053.00	D/F End Panel, 28 3/8" x 79 3/4" H	58
59-731-S02	\$ 1,038.00	D/F End Panel, 24 3/8" x 85 3/4" H	52
59-732-S02	\$ 1,077.00	D/F End Panel, 28 3/8" x 85 3/4" H	62
59-734-S02	\$ 1,080.00	D/F End Panel, 24 3/8" x 91 3/4" H	56
59-735-S02	\$ 1,122.00	D/F End Panel, 28 3/8" x 91 3/4" H	67



**Note: Heights noted are to the bottom of the curve on the top of the panel**

**Please specify Wood Finish, Metal and Glass (if applicable). Details can be found in the Product Options section at the front of this Price List.**

**End Panels for Steel Shelving**  
**Horizons Collection (prices shown in Maple wood)**  
**2009 Brodart Furniture - List Prices**

**Note: End Panels are not machined. No fastening hardware is provided with End Panels**

Catalog Number	List Price	Description	# of Laser Cutouts Available per Panel	Weight (lbs)
----------------	------------	-------------	---	--------------

**End Panels for Steel Shelving w/o Continuous Tops**

**Single Faced**

77-702-S00	\$ 963.00	S/F End Panel, 12 1/4" x 42 1/2" H	3	14
77-703-S00	\$ 969.00	S/F End Panel, 14 1/4" x 42 1/2" H	3	16
77-705-S00	\$ 1,212.00	S/F End Panel, 12 1/4" x 66 1/2" H	4	21
77-706-S00	\$ 1,223.00	S/F End Panel, 14 1/4" x 66 1/2" H	4	26
77-708-S00	\$ 1,293.00	S/F End Panel, 12 1/4" x 78 1/2" H	4	25
77-709-S00	\$ 1,307.00	S/F End Panel, 14 1/4" x 78 1/2" H	4	30
77-711-S00	\$ 1,331.00	S/F End Panel, 12 1/4" x 84 1/2" H	4	28
77-712-S00	\$ 1,346.00	S/F End Panel, 14 1/4" x 84 1/2" H	4	33
77-714-S00	\$ 1,460.00	S/F End Panel, 12 1/4" x 90 1/2" H	5	29
77-715-S00	\$ 1,475.00	S/F End Panel, 14 1/4" x 90 1/2" H	5	35

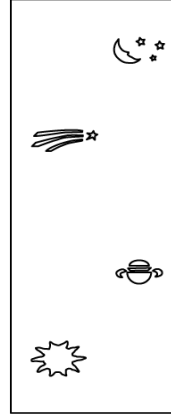

**Double Face**

77-722-S00	\$ 1,044.00	D/F End Panel, 21" x 42 1/2" H	3	27
77-723-S00	\$ 1,059.00	D/F End Panel, 25" x 42 1/2" H	3	33
77-725-S00	\$ 1,360.00	D/F End Panel, 21" x 66 1/2" H	4	43
77-726-S00	\$ 1,379.00	D/F End Panel, 25" x 66 1/2" H	4	52
77-728-S00	\$ 1,448.00	D/F End Panel, 21" x 78 1/2" H	4	51
77-729-S00	\$ 1,470.00	D/F End Panel, 25" x 78 1/2" H	4	61
77-731-S00	\$ 1,492.00	D/F End Panel, 21" x 84 1/2" H	4	55
77-732-S00	\$ 1,515.00	D/F End Panel, 25" x 84 1/2" H	4	66
77-734-S00	\$ 1,625.00	D/F End Panel, 21" x 90 1/2" H	5	46
77-735-S00	\$ 1,648.00	D/F End Panel, 25" x 90 1/2" H	5	70

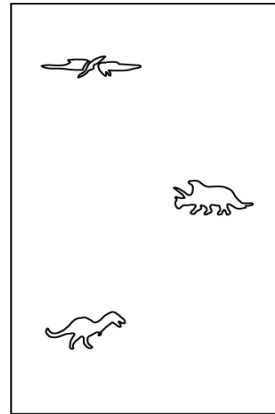

**Please specify Wood Finish and Cut Outs. Details can be found in the Product Options section at the front of this Price List.**

**End Panels for Steel Shelving**  
**Horizons Collection (prices shown in Maple wood)**  
**2009 Brodart Furniture - List Prices**

**Note: End Panels are not machined. No fastening hardware is provided with End Panels**

Catalog Number	List Price	Description	# of Laser Cutouts	Available per Panel	Weight (lbs)
<b>End Panels for Steel Shelving w/Continuous Tops</b>					
<b>Single Faced</b>					
77-702-S02	\$ 963.00	S/F End Panel, 13 7/8" x 43 3/4" H		3	14
77-703-S02	\$ 969.00	S/F End Panel, 15 7/8" x 43 3/4" H		3	16
77-705-S02	\$ 1,212.00	S/F End Panel, 13 7/8" x 67 3/4" H		4	21
77-706-S02	\$ 1,223.00	S/F End Panel, 15 7/8" x 67 3/4" H		4	26
77-708-S02	\$ 1,293.00	S/F End Panel, 13 7/8" x 79 3/4" H		4	25
77-709-S02	\$ 1,307.00	S/F End Panel, 15 7/8" x 79 3/4" H		4	30
77-711-S02	\$ 1,331.00	S/F End Panel, 13 7/8" x 85 3/4" H		4	28
77-712-S02	\$ 1,346.00	S/F End Panel, 15 7/8" x 85 3/4" H		4	33
77-714-S02	\$ 1,460.00	S/F End Panel, 13 7/8" x 91 3/4" H		5	29
77-715-S02	\$ 1,475.00	S/F End Panel, 15 7/8" x 91 3/4" H		5	35
<b>Double Faced</b>					
77-722-S02	\$ 1,044.00	D/F End Panel, 24 3/8" x 43 3/4" H		3	27
77-723-S02	\$ 1,059.00	D/F End Panel, 28 3/8" x 43 3/4" H		3	33
77-725-S02	\$ 1,360.00	D/F End Panel, 24 3/8" x 67 3/4" H		4	43
77-726-S02	\$ 1,379.00	D/F End Panel, 28 3/8" x 67 3/4" H		4	52
77-728-S02	\$ 1,448.00	D/F End Panel, 24 3/8" x 79 3/4" H		4	51
77-729-S02	\$ 1,470.00	D/F End Panel, 28 3/8" x 79 3/4" H		4	61
77-731-S02	\$ 1,492.00	D/F End Panel, 24 3/8" x 85 3/4" H		4	55
77-732-S02	\$ 1,515.00	D/F End Panel, 28 3/8" x 85 3/4" H		4	66
77-734-S02	\$ 1,625.00	D/F End Panel, 24 3/8" x 91 3/4" H		5	46
77-735-S02	\$ 1,648.00	D/F End Panel, 28 3/8" x 91 3/4" H		5	70

**Please specify Wood Finish and Cut Outs. Details can be found in the Product Options section at the front of this Price List.**

**End Panels for Steel Shelving**  
**Matrix Collection (prices shown in Maple wood)**  
**2009 Brodart Furniture - List Prices**

**Note: End Panels are not machined. No fastening hardware is provided with End Panels**

Catalog Number	List Price	Description	Weight (lbs)
----------------	------------	-------------	--------------

**End Panels for Steel Shelving w/o Continuous Tops**

**Single Faced**

93-702-S00	\$ 427.00	S/F End Panel, 12 1/4" x 42 1/2" H	10
93-703-S00	\$ 442.00	S/F End Panel, 14 1/4" x 42 1/2" H	12
93-705-S00	\$ 519.00	S/F End Panel, 12 1/4" x 66 1/2" H	16
93-706-S00	\$ 527.00	S/F End Panel, 14 1/4" x 66 1/2" H	19
93-708-S00	\$ 540.00	S/F End Panel, 12 1/4" x 78 1/2" H	15
93-709-S00	\$ 548.00	S/F End Panel, 14 1/4" x 78 1/2" H	24
93-711-S00	\$ 548.00	S/F End Panel, 12 1/4" x 84 1/2" H	18
93-712-S00	\$ 558.00	S/F End Panel, 14 1/4" x 84 1/2" H	27
93-714-S00	\$ 558.00	S/F End Panel, 12 1/4" x 90 1/2" H	20
93-715-S00	\$ 564.00	S/F End Panel, 14 1/4" x 90 1/2" H	29

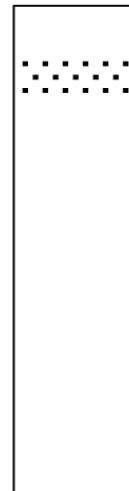

**Double Faced**

93-722-S00	\$ 532.00	D/F End Panel, 21" x 42 1/2" H	20
93-723-S00	\$ 539.00	D/F End Panel, 25" x 42 1/2" H	24
93-725-S00	\$ 666.00	D/F End Panel, 21" x 66 1/2" H	32
93-726-S00	\$ 680.00	D/F End Panel, 25" x 66 1/2" H	38
93-728-S00	\$ 688.00	D/F End Panel, 21" x 78 1/2" H	30
93-729-S00	\$ 744.00	D/F End Panel, 25" x 78 1/2" H	48
93-731-S00	\$ 693.00	D/F End Panel, 21" x 84 1/2" H	36
93-732-S00	\$ 706.00	D/F End Panel, 25" x 84 1/2" H	54
93-734-S00	\$ 706.00	D/F End Panel, 21" x 90 1/2" H	40
93-735-S00	\$ 716.00	D/F End Panel, 25" x 90 1/2" H	58

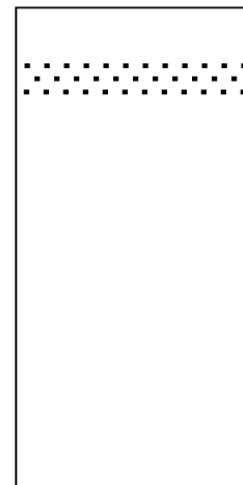

**Please specify Wood Finish. Details can be found in the Product Options section at the front of this Price List.**



**End Panels for Steel Shelving**  
**Matrix Collection (prices shown in Maple wood)**  
**2009 Brodart Furniture - List Prices**

**Note: End Panels are not machined. No fastening hardware is provided with End Panels**

Catalog Number	List Price	Description	Weight (lbs)
----------------	------------	-------------	--------------

**End Panels for Steel Shelving w/Continuous Tops**

**Single Faced**

93-702-S02	\$ 427.00	S/F End Panel, 13 7/8" x 43 3/4" H	10
93-703-S02	\$ 442.00	S/F End Panel, 15 7/8" x 43 3/4" H	12
93-705-S02	\$ 519.00	S/F End Panel, 13 7/8" x 67 3/4" H	16
93-706-S02	\$ 527.00	S/F End Panel, 15 7/8" x 67 3/4" H	19
93-708-S02	\$ 540.00	S/F End Panel, 13 7/8" x 79 3/4" H	15
93-709-S02	\$ 548.00	S/F End Panel, 15 7/8" x 79 3/4" H	24
93-711-S02	\$ 548.00	S/F End Panel, 13 7/8" x 85 3/4" H	18
93-712-S02	\$ 558.00	S/F End Panel, 15 7/8" x 85 3/4" H	27
93-714-S02	\$ 558.00	S/F End Panel, 13 7/8" x 91 3/4" H	20
93-715-S02	\$ 564.00	S/F End Panel, 15 7/8" x 91 3/4" H	29

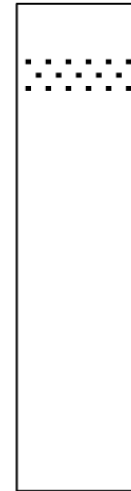

**Double Faced**

93-722-S02	\$ 532.00	D/F End Panel, 24 3/8" x 43 3/4" H	20
93-723-S02	\$ 539.00	D/F End Panel, 28 3/8" x 43 3/4" H	24
93-725-S02	\$ 666.00	D/F End Panel, 24 3/8" x 67 3/4" H	32
93-726-S02	\$ 680.00	D/F End Panel, 28 3/8" x 67 3/4" H	38
93-728-S02	\$ 688.00	D/F End Panel, 24 3/8" x 79 3/4" H	30
93-729-S02	\$ 744.00	D/F End Panel, 28 3/8" x 79 3/4" H	48
93-731-S02	\$ 693.00	D/F End Panel, 24 3/8" x 85 3/4" H	36
93-732-S02	\$ 706.00	D/F End Panel, 28 3/8" x 85 3/4" H	54
93-734-S02	\$ 706.00	D/F End Panel, 24 3/8" x 91 3/4" H	40
93-735-S02	\$ 716.00	D/F End Panel, 28 3/8" x 91 3/4" H	58

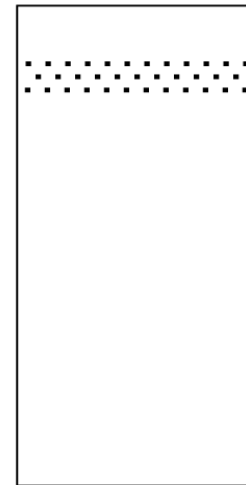

**Please specify Wood Finish. Details can be found in the Product Options section at the front of this Price List.**

**End Panels for Steel Shelving**  
**Quorum 94T Series (prices shown in Oak wood)**  
**2009 Brodart Furniture - List Prices**

**Note: End Panels are not machined. No fastening hardware is provided with End Panels**

Catalog Number	List Price	Description	Weight (lbs)
----------------	------------	-------------	--------------

**End Panels for Steel Shelving w/o Continuous Tops**

**Single Faced**

94T-702-S00	\$ 255.00	S/F End Panel, 12 1/4" x 42 1/2" H
94T-703-S00	\$ 266.00	S/F End Panel, 14 1/4" x 42 1/2" H
94T-705-S00	\$ 326.00	S/F End Panel, 12 1/4" x 66 1/2" H
94T-706-S00	\$ 331.00	S/F End Panel, 14 1/4" x 66 1/2" H
94T-708-S00	\$ 344.00	S/F End Panel, 12 1/4" x 78 1/2" H
94T-709-S00	\$ 349.00	S/F End Panel, 14 1/4" x 78 1/2" H
94T-711-S00	\$ 349.00	S/F End Panel, 12 1/4" x 84 1/2" H
94T-712-S00	\$ 358.00	S/F End Panel, 14 1/4" x 84 1/2" H
94T-714-S00	\$ 358.00	S/F End Panel, 12 1/4" x 90 1/2" H
94T-715-S00	\$ 361.00	S/F End Panel, 14 1/4" x 90 1/2" H

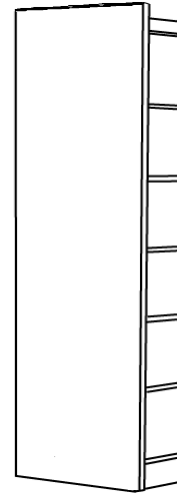

14
16
21
26
25
30
28
33
29
35

**Double Faced**

94T-722-S00	\$ 326.00	D/F End Panel, 21" x 42 1/2" H
94T-723-S00	\$ 331.00	D/F End Panel, 25" x 42 1/2" H
94T-725-S00	\$ 432.00	D/F End Panel, 21" x 66 1/2" H
94T-726-S00	\$ 444.00	D/F End Panel, 25" x 66 1/2" H
94T-728-S00	\$ 450.00	D/F End Panel, 21" x 78 1/2" H
94T-729-S00	\$ 494.00	D/F End Panel, 25" x 78 1/2" H
94T-731-S00	\$ 454.00	D/F End Panel, 21" x 84 1/2" H
94T-732-S00	\$ 463.00	D/F End Panel, 25" x 84 1/2" H
94T-734-S00	\$ 463.00	D/F End Panel, 21" x 90 1/2" H
94T-735-S00	\$ 471.00	D/F End Panel, 25" x 90 1/2" H

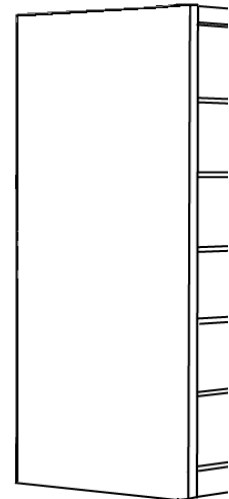

27
33
43
52
51
61
55
66
59
60

**94 Series (full bullnose) furniture is available at a 25% price increases over 94T product.**

**Please specify Wood Finish. Details can be found in the Product Options section at the front of this Price List.**

**End Panels for Steel Shelving**  
**Quorum 94T Series (prices shown in Oak wood)**  
**2009 Brodart Furniture - List Prices**

**Note: End Panels are not machined. No fastening hardware is provided with End Panels**

Catalog Number	List Price	Description	Weight (lbs)
----------------	------------	-------------	--------------

**End Panels for Steel Shelving w/o Continuous Tops**

**Single Faced**

94T-702-S02	\$ 255.00	S/F End Panel, 13 7/8" x 43 3/4" H	14
94T-703-S02	\$ 266.00	S/F End Panel, 15 7/8" x 43 3/4" H	16
94T-705-S02	\$ 326.00	S/F End Panel, 13 7/8" x 67 3/4" H	21
94T-706-S02	\$ 331.00	S/F End Panel, 15 7/8" x 67 3/4" H	26
94T-708-S02	\$ 344.00	S/F End Panel, 13 7/8" x 79 3/4" H	25
94T-709-S02	\$ 349.00	S/F End Panel, 15 7/8" x 79 3/4" H	30
94T-711-S02	\$ 349.00	S/F End Panel, 13 7/8" x 85 3/4" H	28
94T-712-S02	\$ 358.00	S/F End Panel, 15 7/8" x 85 3/4" H	33
94T-714-S02	\$ 358.00	S/F End Panel, 13 7/8" x 91 3/4" H	29
94T-715-S02	\$ 361.00	S/F End Panel, 15 7/8" x 91 3/4" H	35

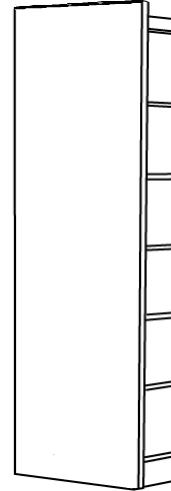

**Double Faced**

94T-722-S02	\$ 326.00	D/F End Panel, 24 3/8" x 43 3/4" H	27
94T-723-S02	\$ 331.00	D/F End Panel, 28 3/8" x 43 3/4" H	33
94T-725-S02	\$ 432.00	D/F End Panel, 24 3/8" x 67 3/4" H	43
94T-726-S02	\$ 444.00	D/F End Panel, 28 3/8" x 67 3/4" H	52
94T-728-S02	\$ 450.00	D/F End Panel, 24 3/8" x 79 3/4" H	51
94T-729-S02	\$ 494.00	D/F End Panel, 28 3/8" x 79 3/4" H	61
94T-731-S02	\$ 454.00	D/F End Panel, 24 3/8" x 85 3/4" H	55
94T-732-S02	\$ 463.00	D/F End Panel, 28 3/8" x 85 3/4" H	66
94T-734-S02	\$ 463.00	D/F End Panel, 24 3/8" x 91 3/4" H	59
94T-735-S02	\$ 471.00	D/F End Panel, 28 3/8" x 91 3/4" H	60

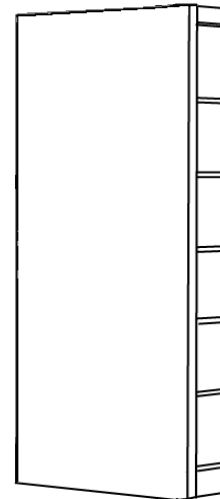

**94 Series (full bullnose) furniture is available at a 25% price increases over 94T product.**

**Please specify Wood Finish. Details can be found in the Product Options section at the front of this Price List.**

## End Panels

### Slatwall End Panels for Wood Shelving (prices shown in Oak wood)

#### 2009 Brodart Furniture - List Prices







Catalog Number	List Price	Description	Weight (lbs)
60-040-S00	\$ 519.00	Slatwall End Panel, 20" x 3/4" x 42"H	40
60-041-S00	\$ 526.00	Slatwall End Panel, 24" x 3/4" x 42" H	45
60-098-S00	\$ 535.00	Slatwall End Panel, 20" x 3/4" x 48"H	45
60-099-S00	\$ 545.00	Slatwall End Panel, 24" x 3/4" x 48"H	50
60-042-S00	\$ 683.00	Slatwall End Panel, 20" x 3/4" x 60-1/2"	55
60-043-S00	\$ 701.00	Slatwall End Panel, 24" x 3/4" x 60-1/2"	65
60-044-S00	\$ 778.00	Slatwall End Panel, 20" x 3/4" x 82"	70
60-045-S00	\$ 796.00	Slatwall End Panel, 24" x 3/4" x 82"	80

**Note:** Slatwall End Panels are designed to be used in conjunction with existing end panels. Please use as an "add-on" feature only. Attaching hardware not included.

**Please specify Wood Finish. Details can be found in the Product Options section at the front of this Price List.**





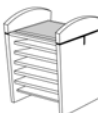





**Display Furniture  
Atlas/Dictionary Stands  
2009 Brodart Furniture - List Prices**

Catalog Number	List Price	Description		Weight (lbs)
<b>Berwyn Series (Cherry Wood)</b>				
66-869-S00	\$ 3,650.00	Dictionary Stand, 28 3/4" x 30 3/4" x 45 1/4" H		200
66-871-S00	\$ 4,282.00	Atlas Stand, 28 3/4" x 30 3/4" x 45 1/4" H		200
<b>Chancellor's Collection (Oak Wood)</b>				
CH2-869-S00	\$ 2,373.00	Dictionary Stand, 15 3/4" x 25 7/8" x 45" H		200
CH2-871-S00	\$ 3,847.00	Atlas Stand, 29 3/4" x 29 1/4" x 45" H		250
<b>Epoch Collection (Maple Wood)</b>				
59GP-869-S00	\$ 3,715.00	Dictionary Stand w/ Glass Window and Painted Accent		200
59GC-869-S00	\$ 4,319.00	Dictionary Stand w/ Glass Window and Chrome Accent		200
59TP-869-S00	\$ 3,178.00	Dictionary Stand w/ Painted Metal Accents		200
59TC-869-S00	\$ 3,827.00	Dictionary Stand w/ Chrome Metal Accents		200
59GP-871-S00	\$ 4,561.00	Atlas Stand w/ Glass Window and Painted Accent		225
59GC-871-S00	\$ 5,165.00	Atlas Stand w/ Glass Window and Chrome Accent		225
59TP-871-S00	\$ 4,010.00	Atlas Stand w/ Painted Metal Accents		225
59TC-871-S00	\$ 4,635.00	Atlas Stand w/ Chrome Metal Accents		225





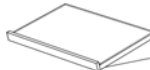













**Please specify Wood Finish, Plastic Laminate, Metal Color, and Glass (if applicable). Details can be found in the Product Options section at the front of this Price List.**

**Display Furniture**  
**Atlas/Dictionary Stands**  
**2009 Brodart Furniture - List Prices**

Catalog Number	List Price	Description		Weight (lbs)
<b>Libris Series (Oak Wood)</b>				
<b>Dictionary Stands w/ Wood Posts</b>				
4W-869-S00	\$ 1,461.00	Adult Dictionary Stand, 17 3/4" x 25 7/8" x 45" H		210
4W-469-S00	\$ 1,461.00	Children's Dictionary Stand, 17 3/4" x 25 7/8" x 38" H		200
<b>Dictionary Stands, w/ Metal Posts</b>				
4M-869-S00	\$ 1,626.00	Adult Dictionary Stand, 17 3/4" x 25 7/8" x 45" H		210
4M-469-S00	\$ 1,626.00	Children's Dictionary Stand, 17 3/4" x 25 7/8" x 38" H		200
<b>Atlas Stands w/ Wood Posts</b>				
4W-871-S00	\$ 2,800.00	Adult Atlas Stand, 30 1/2" x 30" x 45" H		250
4W-471-S00	\$ 2,800.00	Children's Atlas Stand, 30 1/2" x 30" x 38" H		240
<b>Atlas Stands, w/ Metal Posts</b>				
4M-871-S00	\$ 3,111.00	Adult Atlas Stand, 30 1/2" x 30" x 45" H		250
4M-471-S00	\$ 3,111.00	Children's Atlas Stand, 30 1/2" x 30" x 38" H		240
<b>Matrix Series (Maple Wood)</b>				
93-869-S00	\$ 2,045.00	Adult Dictionary Stand, 15 3/4" x 25 7/8" x 45" H		210
93-469-S00	\$ 2,045.00	Children's Dictionary Stand, 15 3/4" x 26 3/8" x 38" H		200
93-871-S00	\$ 3,678.00	Adult Atlas Stand, 28 1/4" x 30" x 45" H		250
93-471-S00	\$ 3,678.00	Children's Atlas Stand, 28 1/4" x 30" x 38" H		240
<b>Quorum 94T Series (Oak Wood)</b>				
94T-869-S00	\$ 1,487.00	Adult Dictionary Stand, 16 1/2" x 25 7/8" x 45 1/2" H		210
94T-469-S00	\$ 1,487.00	Children's Dictionary Stand, 16 1/2" x 25 7/8" x 38 1/2" H		200
94T-871-S00	\$ 2,839.00	Adult Atlas Stand, 29" x 30" x 45 4/2" H		250
94T-471-S00	\$ 2,839.00	Children's Atlas Stand, 29" x 30" x 38 1/2" H		240
60-854-S00	\$ 370.00	Revolving Dictionary Stand, Oak Wood		10
60-854-S00MAP	\$ 394.00	Revolving Dictionary Stand, Maple Wood		10

**Please specify Wood Finish, Plastic Laminate, and Metal Color (if applicable). Details can be found in the Product Options section at the front of this Price List.**

**Display Furniture**  
**A-Frame Display/Exhibit Cases**  
**2009 Brodart Furniture - List Prices**

Catalog Number	List Price	Description		Weight (lbs)
<b>A-Frame Display Shelving</b>				
60-048-S00	\$ 1,519.00	A-Frame Shelving, 42" H Single-Face Starter		107
60-049-S00	\$ 1,325.00	A-Frame Shelving, 42" H Single-Face Adder		107
60-050-S00	\$ 1,837.00	A-Frame Shelving, 60 1/2" H Single-Face Starter		148
60-051-S00	\$ 1,561.00	A-Frame Shelving, 60 1/2" H Single-Face Adder		148
60-022-S00	\$ 2,535.00	A-Frame Shelving, 42" H Double-Face Starter		214
60-023-S00	\$ 2,295.00	A-Frame Shelving, 42" H Double-Face Adder		184
60-024-S00	\$ 3,235.00	A-Frame Shelving, 60 1/2" H Double-Face Starter		296
60-025-S00	\$ 2,601.00	A-Frame Shelving, 60 1/2" H Double-Face Adder		248
60-245-S00	\$ 887.00	42"H Slatwall End Panel for D/F A-Frame Display		60
60-246-S00	\$ 968.00	60 1/2"H Slatwall End Panel for D/F A-Frame Display		65
60-056-S00	\$ 4,914.00	Mobile Bookstore Displayer w/ Storage		289
60-738-S00	\$ 2,976.00	D/F A-Frame Slatwall w/ Casters		185
60-739-S00	\$ 2,692.00	D/F A-Frame Slatwall w/o Casters		172
<b>Exhibit Cases</b>				
60-452-S00	\$ 8,990.00	Classic Oak Display Case, 20"D x 48"W x 82"H		400
60-456-S00	\$ 684.00	Optional Lighting		10
60-168-S00	\$ 7,101.00	Leg Base Exhibit Case, 20"D x 48"W x 82"H		320
60-169-S00	\$ 4,900.00	Cube Display Case, 24"D x 24"W x 82"H		185
60-166-S00	\$ 5,158.00	Horizontal Exhibit Case, 8"H Display, 36"D x 72"W x 37"H		200
60-167-S00	\$ 5,515.00	Horizontal Exhibit Case, 14"H Display, 36"D x 72"W x 43"H		220
60-454-S00	\$ 5,042.00	Classic Horizontal Exhibit Case, 8"H Display, 36"D x 72"W x 37"H		200
60-333-S00	\$ 5,969.00	Horizontal Flip Top Exhibit, 8"H Display, 36"D x 72"W x 37"H		210
60-334-S00	\$ 6,346.00	Horizontal Flip Top Exhibit, 14"H Display, 36"D x 72"W x 43"H		240

**Please specify Wood Finish. Details can be found in the Product Options section at the front of this Price List.**



**Display Furniture**  
**Gondola Metal Display Shelving**  
**2009 Brodart Furniture - List Prices**

Catalog Number	List Price	Description	Weight (lbs)
----------------	------------	-------------	--------------

**Gondola Metal Display Shelving**

**Book Shelf Units**

63-100-S00	\$ 2,854.00	S/F Book Shelf Unit, Starter	70
63-101-S00	\$ 2,250.00	S/F Book Shelf Unit, Adder	60
63-102-S00	\$ 4,420.00	D/F Book Shelf Unit, Starter	110
63-104-S00	\$ 3,779.00	D/F Book Shelf Unit, Adder	100



**Media Shelf Units**

63-105-S00	\$ 2,938.00	S/F Media Shelf Unit, Starter	70
63-106-S00	\$ 2,325.00	S/F Media Shelf Unit, Adder	60
* Includes 1 pack of 35 dividers			
63-107-S00	\$ 4,583.00	D/F Media Shelf Unit, Starter	110
63-108-S00	\$ 3,993.00	D/F Media Shelf Unit, Adder	100

\* Includes 2 packs of 35 dividers

63-113-S00	\$ 208.00	Package of Dividers (35)	21
------------	-----------	--------------------------	----

**Note: Dividers only available with Media Shelves**

**End Panels and Back Panels (prices shown in Oak wood)**











EP-108-S00	\$ 659.00	Left End Panel S/F	45
EP-109-S00	\$ 659.00	Right End Panel S/F	45
EP-110-S00	\$ 987.00	Solid End Panel D/F	65
EP-111-S00	\$ 1,512.00	Slatwall End Panel D/F	70
EP-112-S00	\$ 189.00	Back Panel	20



**\*\*Note: These units are 25% longer than traditional display units**







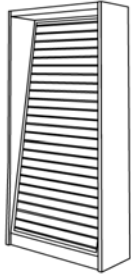

**Please specify Wood Finish and Metal Color (if applicable). Details can be found in the Product Options section at the front of this Price List.**

**Display Furniture**  
**End of Range/Magazine & Newspaper Displayers**  
**2009 Brodart Furniture - List Prices**

Catalog Number	List Price	Description		Weight (lbs)
<b>End of Range Shelving and Display</b>				
<b>End of Range Displayers</b>				
60-013-S00	\$ 1,494.00	End of Range Book Displayer		163
60-115-S00	\$ 1,494.00	End of Range Magazine/Newspaper Display		125
<b>End of Range Shelving</b>				
<b>Oak Wood</b>				
S1-120-S00	\$ 1,229.00	EOR Shelving, 12"D X 20"W X 82"H, Oak		165
S1-121-S00	\$ 1,240.00	EOR Shelving, 12"D X 24"W X 82"H, Oak		204
S1-118-S00	\$ 1,136.00	EOR Shelving, 12"D X 20"W X 60 1/2"H, Oak		129
S1-119-S00	\$ 1,147.00	EOR Shelving, 12"D X 24"W X 60 1/2"H, Oak		160
S1-116-S00	\$ 858.00	EOR Shelving, 12"D X 20"W X 48"H, Oak		101
S1-117-S00	\$ 869.00	EOR Shelving, 12"D X 24"W X 48"H, Oak		124
S1-114-S00	\$ 834.00	EOR Shelving, 12"D X 20"W X 42"H, Oak		91
S1-115-S00	\$ 846.00	EOR Shelving, 12"D X 24"W X 42"H, Oak		114
<b>Maple Wood</b>				
1S-120-S00	\$ 1,290.00	EOR Shelving, 12"D X 20"W X 82"H, Maple		165
1S-121-S00	\$ 1,302.00	EOR Shelving, 12"D X 24"W X 82"H, Maple		204
1S-118-S00	\$ 1,193.00	EOR Shelving, 12"D X 20"W X 60 1/2"H, Maple		129
1S-119-S00	\$ 1,205.00	EOR Shelving, 12"D X 24"W X 60 1/2"H, Maple		160
1S-116-S00	\$ 901.00	EOR Shelving, 12"D X 20"W X 48"H, Maple		101
1S-117-S00	\$ 913.00	EOR Shelving, 12"D X 24"W X 48"H, Maple		124
1S-114-S00	\$ 876.00	EOR Shelving, 12"D X 20"W X 42"H, Maple		91
1S-115-S00	\$ 888.00	EOR Shelving, 12"D X 24"W X 42"H, Maple		114
<b>End of Range Computer Station</b>				
60-052-S00	\$ 1,767.00	EOR Computer Station, 82"H, for wood shelving		125
60-053-S00	\$ 1,938.00	EOR Computer Station, 84"H, for steel shelving		135
<b>End of Range OPAC</b>				
60-012-S00	\$ 1,181.00	EOR OPAC Unit, 16"D x 24"W x 40 1/2"H		110
<b>Magazine/Newspaper Displayers</b>				
60-203-S00	\$ 3,710.00	Newspaper Displayer		100
64-179-S00	\$ 1,684.00	Horizontal Newspaper Rack, 64 Series		55
94T-179-S00	\$ 1,565.00	Horizontal Newspaper Rack, 94T Series		55
60-180-S00	\$ 1,378.00	Newspaper Rack, Vertical		50
60-969-S00	\$ 327.00	Newspaper Rack, Wall Mounted		17
60-868-S00	\$ 1,908.00	Magazine Rack		200

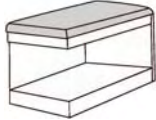
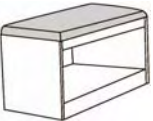
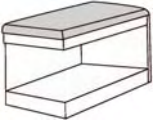
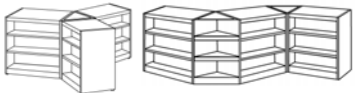











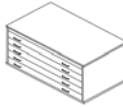
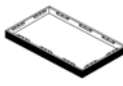

Please specify Wood Finish. Details can be found in the Product Options section at the front of this Price List.

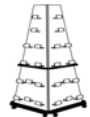
**Display Furniture**  
**Slatwall/Specialty Shelving & Display**  
**2009 Brodart Furniture - List Prices**

Catalog Number	List Price	Description		Weight (lbs)
<b>Slatwall Shelving</b>				
S1-113-S00	\$ 1,579.00	Slatwall Shelving, Starter Oak		96
1S-113-S00	\$ 1,443.00	Slatwall Shelving, Starter Maple		96
S2-113-S00	\$ 1,188.00	Slatwall Shelving, Adder Oak		81
2S-113-S00	\$ 1,187.00	Slatwall Shelving, Adder Maple		81
S1-112-S00	\$ 1,686.00	Slatwall Shelving, Starter Oak		112
1S-112-S00	\$ 1,557.00	Slatwall Shelving, Starter Maple		112
S2-112-S00	\$ 1,321.00	Slatwall Shelving, Adder Oak		92
2S-112-S00	\$ 1,281.00	Slatwall Shelving, Adder Maple		92
<b>Slatwall Display</b>				
60-070-S00	\$ 2,710.00	3-Sided Slatwall Kiosk		300
60-800-S00	\$ 3,879.00	3-Sided Multimedia Kiosk		325
60-801-S00	\$ 286.00	Optional Cork Board for Kiosk		20
60-037-S00	\$ 2,619.00	Four-Sided Displayer Slatwall/Shelf w/ Casters		90
60-038-S00	\$ 2,311.00	Four-Sided Displayer Slatwall/Shelf w/o Casters		85
<b>Specialty Shelving</b>				
S1-600-S00	\$ 796.00	Shelving Bench Starter, 12"D x 21"H, Oak		45
S2-600-S00	\$ 687.00	Shelving Bench Adder, 12"D x 21"H, Oak		45
S1-601-S00	\$ 860.00	Shelving Bench Starter, 16"D x 21"H, Oak		50
S2-601-S00	\$ 737.00	Shelving Bench Adder, 16"D x 21"H, Oak		50
1S-600-S00	\$ 837.00	Shelving Bench Starter, 12"D x 21"H, Maple		45
2S-600-S00	\$ 727.00	Shelving Bench Adder, 12"D x 21"H, Maple		45
1S-601-S00	\$ 912.00	Shelving Bench Starter, 16"D x 21"H, Maple		50
2S-601-S00	\$ 792.00	Shelving Bench Adder, 16"D x 21"H, Maple		50
S9-200-S00	\$ 4,995.00	Design-Flex Shelving-Tri Star		400
S1-197-S00	\$ 6,276.00	Design-Flex Shelving-Serpentine		400
S9-202-S00	\$ 2,493.00	FYI Reference Shelving - Starter		145
S0-202-S00	\$ 1,625.00	FYI Reference Shelving - Adder		125
60-274-S00	\$ 6,584.00	Readers Roost, Oak Wood		375
77-274-S00	\$ 6,135.00	Readers Roost, Maple Wood, 49 1/4" x 85" x 42"H		375

**Please specify Wood Finish, Upholstery, and Plastic Laminate (if applicable). Details can be found in the Product Options section at the front of this Price List.**

**Display Furniture**  
**Miscellaneous/Mobile/Horizons Display**  
**2009 Brodart Furniture - List Prices**

Catalog Number	List Price	Description		Weight (lbs)
<b>Miscellaneous Displayers</b>				
60-228-S00	\$ 2,073.00	Large 3-Tier Displayer		350
60-239-S00	\$ 3,680.00	Octagonal Display with Riser		200
60-242-S00	\$ 3,178.00	Octagonal Display without Riser		175
60-899-S00	\$ 5,262.00	Map Cabinet		225
60-900-S00	\$ 275.00	Map Cabinet Base		10
<b>Mobile Displayers</b>				
60-303-S00	\$ 3,120.00	46"H Mobile Multimedia Kiosk		175
60-304-S00	\$ 3,953.00	68"H Mobile Multimedia Kiosk		200
60-307-S00	\$ 2,636.00	3-Side Pyramid Display		195
60-309-S00	\$ 3,362.00	4-Side Pyramid Display		245
60-112-S00	\$ 6,647.00	D/F Mobile Book Browser w/ Casters		200
60-113-S00	\$ 3,605.00	S/F Mobile Book Browser w/ Casters		175
64-017-S00	\$ 3,350.00	Mobile Magazine Book Displayer		150
<b>Horizons Series Display Furniture</b>				
77-112-S00	\$ 5,957.00	D/F Book Browser/Storage, Maple - Large w/ Cutouts		300
77-262-S00	\$ 2,915.00	D/F Book Browser/Storage, Maple - Small w/ Cutouts		200
77-263-S00	\$ 4,172.00	D/F Browser/Bench Combo w/ Cutouts, Maple		190
77-264-S00	\$ 3,601.00	S/F Browser/Bench Combo w/ Cutouts, Maple		140









**Please specify Wood Finish, Plastic Laminate, and Cut-Outs (if applicable). Details can be found in the Product Options section at the front of this Price List.**

**Display Furniture**  
**Multimedia Display & Storage**  
**2009 Brodart Furniture - List Prices**

Catalog Number	List Price	Description	Weight (lbs)
----------------	------------	-------------	--------------

**Multimedia Display**

**Media Browsers/Displayers**

















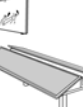

60-072-S00	\$ 2,516.00	42" H CD Display Center, Starter	 110
60-071-S00	\$ 2,318.00	42" H CD Display Center, Adder	 90
60-075-S00	\$ 3,034.00	61" H CD Display Center, Starter	 145
60-074-S00	\$ 2,671.00	61" H CD Display Center, Adder	 125
60-751-S00	\$ 1,807.00	Classic CD Browser, Starter	 175
60-752-S00	\$ 1,506.00	Classic CD Browser, Adder	 150
60-580-S00	\$ 2,277.00	CD/DVD Displayer-table version	 125
60-581-S00	\$ 3,556.00	CD/DVD Displayer-cabinet version	 125
64-771-S00	\$ 5,627.00	CD/DVD Drawer Unit	 250

**Epoch Collection CD/DVD Storage and Display**

59GP-771-S00	\$ 8,189.00	CD/DVD Storage, Glass Window and Painted Accent	 250
59GC-771-S00	\$ 10,202.00	CD/DVD Storage, Glass Window and Chrome Accent	 250
59TP-771-S00	\$ 8,118.00	CD/DVD Storage, w/ Painted Metal Accents	 250
59TC-771-S00	\$ 9,741.00	CD/DVD Storage, w/ Chrome Metal Accents	 250
59-771-S02	\$ 7,618.00	CD/DVD Storage, Adder Unit	 230
59GP-771-S03	\$ 8,089.00	CD/DVD Display, Glass Window and Painted Accent	 250
59GC-771-S03	\$ 8,897.00	CD/DVD Display, Glass Window and Chrome Accent	 250
59TP-771-S03	\$ 8,023.00	CD/DVD Display, w/ Painted Metal Accents	 250
59TC-771-S03	\$ 9,628.00	CD/DVD Display, w/ Chrome Metal Accents	 250
59-771-S04	\$ 7,518.00	CD/DVD Display, Adder Unit	 230





**Please specify Wood Finish, Metal Color, and Glass (if applicable). Details can be found in the Product Options section at the front of this Price List.**

**Display Furniture**  
**Revolving/Tower/Picture Book Display**  
**2009 Brodart Furniture - List Prices**

Catalog Number	List Price	Description		Weight (lbs)
<b>Revolving Displayers</b>				
60-194-S00	\$ 3,595.00	27" Dia. CD/DVD/Book Displayer, Oak Wood		110
60-234-S00	\$ 3,853.00	27" Dia. CD/DVD/Book Displayer, Maple Wood		110
60-195-S00	\$ 3,346.00	27" Dia. CD Displayer, Oak Wood		110
60-235-S00	\$ 3,824.00	27" Dia. CD Displayer, Maple Wood		110
60-196-S00	\$ 3,231.00	27" Dia. Book Displayer, Oak Wood		110
60-236-S00	\$ 3,231.00	27" Dia. Book Displayer, Maple Wood		110
60-057-S00	\$ 2,721.00	4-Sided Revolving Displayer 48"H		299
60-058-S00	\$ 3,311.00	4-Sided Revolving Displayer 66"H		325
<b>Tower Displayers</b>				
60-415-S00	\$ 2,643.00	Four Tower-Island, 6 Shelf		136
60-215-S00	\$ 2,550.00	Four Tower-Island, 5 Shelf		136
60-416-S00	\$ 4,230.00	Six Tower-Island, 6 Shelf		210
60-216-S00	\$ 4,104.00	Six Tower-Island, 5 Shelf		210
60-417-S00	\$ 2,114.00	Three Tower-Wall 6 Shelf		128
60-217-S00	\$ 2,053.00	Three Tower-Wall 5 Shelf		128
60-418-S00	\$ 4,226.00	Six Tower-Aisle 6 Shelf		266
60-218-S00	\$ 4,104.00	Six Tower-Aisle 5 Shelf		266
<b>Picture Book Table &amp; Bench</b>				
77-140-S00	\$ 3,313.00	Picture Book Table, Maple, 34 1/2" x 48 1/2" x 31 1/2"H		100
77-142-S00	\$ 3,681.00	Picture Book Table, Maple, 34 1/2" x 78 1/2" x 31 1/2"H		190
*Hassocks for Picture Book Tables are located in the Horizons Seating Section				
94T-142-S00	\$ 3,041.00	Picture Book Table, 32" x 78" x 33-1/2"H		190
94T-147-S00	\$ 1,036.00	Picture Book Bench, 11" x 69" x 15 3/4"H		50

**Please specify Wood Finish, and Plastic Laminate (if applicable). Details can be found in the Product Options section at the front of this Price List.**

**Display Furniture**  
**Book Trucks**  
**2009 Brodart Furniture - List Prices**

Catalog Number	List Price	Description		Weight (lbs)
<b>Book Trucks</b>				
60-911-S01	\$ 1,463.00	Large BT, Flat Shelves		82
60-911-S02	\$ 1,774.00	Large BT, Flat Shelves and Rubber Bumpers		82
60-911-S03	\$ 1,506.00	Large BT, Flat Shelves and all Swivel Casters		82
60-911-S04	\$ 1,816.00	Large BT, Flat Shelves w/ Rubber Bumpers and all Swivel Casters		82
60-912-S01	\$ 1,233.00	Small BT, Flat Shelves		78
60-912-S02	\$ 1,544.00	Small BT, Flat Shelves and Rubber Bumpers		78
60-912-S03	\$ 1,275.00	Small BT, Flat Shelves and all Swivel Casters		78
60-912-S04	\$ 1,586.00	Small BT, Flat Shelves w/ Rubber Bumpers and all Swivel Casters		78
60-917-S01	\$ 1,783.00	Large BT, Double-Faced Display		80
60-917-S02	\$ 2,094.00	Large BT, Double-Faced Display and Rubber Bumpers		80
60-917-S03	\$ 1,825.00	Large BT, Double-Faced Display and all Swivel Casters		80
60-917-S04	\$ 2,136.00	Large BT, D/F Display w/ Rubber Bumpers and all Swivel Casters		80
60-919-S01	\$ 1,553.00	Small BT, Double-Faced Display		75
60-919-S02	\$ 1,864.00	Small BT, Double-Faced Display and Rubber Bumpers		75
60-919-S03	\$ 1,595.00	Small BT, Double-Faced Display and all Swivel Casters		75
60-919-S04	\$ 1,907.00	Small BT, D/F Display w/ Rubber Bumpers and all Swivel Casters		75
60-870-S01	\$ 1,009.00	Utility BT		40
60-870-S02	\$ 1,320.00	Utility BT w/ Rubber Bumpers * this unit already comes with all swivel casters		40

**Note:** For Depressible Book Receiving Carts, please refer to the "Circulation Desk Accessories" section

**Please specify Wood Finish. Details can be found in the Product Options section at the front of this Price List.**

**Alpha Chair  
Seating  
2009 Brodart Furniture - List Prices**

Catalog Number	Description	COM	List Price			Weight (lbs)
			Wood/G1	Grade 2	Grade 3	

**Metal Frame, Wood Seat and Back, Oak Wood**

AP2-571-S00	Adult, Wood Seat/Back, Oak		\$ 644.00			25
AP2-561-S00	Youth, Wood Seat/Back, Oak		\$ 644.00			25



**Metal Frame, Upholstered Seat and Back, Oak Wood**

AP2-574-S00	Adult, Uph Seat & Back, Oak	\$ 733.00	\$ 731.00	\$ 914.00	\$ 942.00	25
AP2-564-S00	Youth, Uph Seat & Back, Oak	\$ 683.00	\$ 681.00	\$ 851.00	\$ 879.00	25



**Metal Frame, Wood Seat, Maple Wood**

AP2-571-SMA	Adult, Wood Seat/Back, Maple		\$ 694.00			25
AP2-561-SMA	Youth, Wood Seat/Back, Maple		\$ 694.00			25



**Metal Frame, Upholstered Seat and Back, Maple Wood**

AP2-574-SMA	Adult, Uph Seat & Back, Maple	\$ 798.00	\$ 797.00	\$ 996.00	\$ 1,027.00	25
AP2-564-SMA	Youth, Uph Seat & Back, Maple	\$ 744.00	\$ 742.00	\$ 928.00	\$ 957.00	25









Fabric Requirements - 1 1/2 yd per chair, non-directional, 54" wide

**Please specify Wood Finish, Upholstery, and Metal Color (if applicable). Details can be found in the Product Options section at the front of this Price List.**



**B Series Seating & Stools**  
**Seating**  
**2009 Brodart Furniture - List Prices**

Catalog Number	Description	COM	List Price			Weight (lbs)
			Wood/G1	Grade 2	Grade 3	
<b>Wood Seats, Plywood Construction</b>						
<b>Side Chair, Adult, 18" Leg Base</b>						
B1-551-S00	All Wood		\$ 304.00			23
B1-552-S00	Uph Seat	\$ 358.00	\$ 354.00	\$ 400.00	\$ 414.00	23
B1-553-S00	Uph Back	\$ 347.00	\$ 346.00	\$ 363.00	\$ 377.00	23
B1-554-S00	Uph Back & Seat	\$ 410.00	\$ 404.00	\$ 504.00	\$ 520.00	23
						
<b>Side Chair, Adult, 18" Sled Base</b>						
B2-551-S00	All Wood		\$ 304.00			23
B2-552-S00	Uph Seat	\$ 358.00	\$ 354.00	\$ 400.00	\$ 414.00	23
B2-553-S00	Uph Back	\$ 347.00	\$ 346.00	\$ 363.00	\$ 377.00	23
B2-554-S00	Uph Back & Seat	\$ 410.00	\$ 404.00	\$ 504.00	\$ 520.00	23
						
<b>Side Chair, Youth, 16" Leg Base</b>						
B1-561-S00	All Wood		\$ 304.00			23
B1-562-S00	Uph Seat	\$ 358.00	\$ 354.00	\$ 400.00	\$ 414.00	23
B1-563-S00	Uph Back	\$ 347.00	\$ 346.00	\$ 363.00	\$ 377.00	23
B1-564-S00	Uph Back & Seat	\$ 410.00	\$ 404.00	\$ 504.00	\$ 520.00	23
						
<b>Side Chair, Youth, 16" Sled Base</b>						
B2-561-S00	All Wood		\$ 304.00			23
B2-562-S00	Uph Seat	\$ 358.00	\$ 354.00	\$ 400.00	\$ 414.00	23
B2-563-S00	Uph Back	\$ 347.00	\$ 346.00	\$ 363.00	\$ 377.00	23
B2-564-S00	Uph Back & Seat	\$ 410.00	\$ 404.00	\$ 504.00	\$ 520.00	23
						
<b>Side Chair, Juvenile, 14" Leg Base</b>						
B1-541-S00	All Wood		\$ 304.00			22
B1-542-S00	Uph Seat	\$ 358.00	\$ 354.00	\$ 400.00	\$ 414.00	22
B1-543-S00	Uph Back	\$ 347.00	\$ 346.00	\$ 363.00	\$ 377.00	22
B1-544-S00	Uph Back & Seat	\$ 410.00	\$ 404.00	\$ 504.00	\$ 520.00	22
						
<b>Side Chair, Juvenile, 14" Sled Base</b>						
B2-541-S00	All Wood		\$ 304.00			23
B2-542-S00	Uph Seat	\$ 358.00	\$ 354.00	\$ 400.00	\$ 414.00	23
B2-543-S00	Uph Back	\$ 347.00	\$ 346.00	\$ 363.00	\$ 377.00	23
B2-544-S00	Uph Back & Seat	\$ 410.00	\$ 404.00	\$ 504.00	\$ 520.00	23
						

Fabric Requirements - non-directional, 54" wide  
 Back - 1/4 yard  
 Seat - 1/2 yard

**Please specify Wood Finish, and Upholstery (if applicable). Details can be found in the Product Options section at the front of this Price List.**

**B Series Seating & Stools**  
**Seating**  
**2009 Brodart Furniture - List Prices**

Catalog Number	Description	COM	List Price			Weight (lbs)
			Wood/G1	Grade 2	Grade 3	
<b>Wood Seats, Solid Wood Construction (Saddle Seat)</b>						
<b>Side Chair, Adult, 18" Leg Base</b>						
B1-551-OAK	All Wood		\$ 322.00			23
B1-552-S00	Uph Seat	\$ 358.00	\$ 354.00	\$ 400.00	\$ 414.00	23
B1-553-OAK	Uph Back	\$ 362.00	\$ 361.00	\$ 380.00	\$ 394.00	23
B1-554-S00	Uph Back & Seat	\$ 410.00	\$ 404.00	\$ 504.00	\$ 520.00	23
<b>Side Chair, Adult, 18" Sled Base</b>						
B2-551-OAK	All Wood		\$ 322.00			23
B2-552-S00	Uph Seat	\$ 358.00	\$ 354.00	\$ 400.00	\$ 414.00	23
B2-553-OAK	Uph Back	\$ 362.00	\$ 361.00	\$ 380.00	\$ 394.00	23
B2-554-S00	Uph Back & Seat	\$ 410.00	\$ 404.00	\$ 504.00	\$ 520.00	23
<b>Side Chair, Youth, 16" Leg Base</b>						
B1-561-OAK	All Wood		\$ 322.00			23
B1-562-S00	Uph Seat	\$ 358.00	\$ 354.00	\$ 400.00	\$ 414.00	23
B1-563-OAK	Uph Back	\$ 362.00	\$ 361.00	\$ 380.00	\$ 394.00	23
B1-564-S00	Uph Back & Seat	\$ 410.00	\$ 404.00	\$ 504.00	\$ 520.00	23
<b>Side Chair, Youth, 16" Sled Base</b>						
B2-561-OAK	All Wood		\$ 322.00			23
B2-562-S00	Uph Seat	\$ 358.00	\$ 354.00	\$ 400.00	\$ 414.00	23
B2-563-OAK	Uph Back	\$ 362.00	\$ 361.00	\$ 380.00	\$ 394.00	23
B2-564-S00	Uph Back & Seat	\$ 410.00	\$ 404.00	\$ 504.00	\$ 520.00	23
<b>Side Chair, Juvenile, 14" Leg Base</b>						
B1-541-OAK	All Wood		\$ 322.00			22
B1-542-S00	Uph Seat	\$ 358.00	\$ 354.00	\$ 400.00	\$ 414.00	22
B1-543-OAK	Uph Back	\$ 362.00	\$ 361.00	\$ 380.00	\$ 394.00	22
B1-544-S00	Uph Back & Seat	\$ 410.00	\$ 404.00	\$ 504.00	\$ 520.00	22
<b>Side Chair, Juvenile, 14" Sled Base</b>						
B2-541-OAK	All Wood		\$ 322.00			22
B2-542-S00	Uph Seat	\$ 358.00	\$ 354.00	\$ 400.00	\$ 414.00	22
B2-543-OAK	Uph Back	\$ 362.00	\$ 361.00	\$ 380.00	\$ 394.00	22
B2-544-S00	Uph Back & Seat	\$ 410.00	\$ 404.00	\$ 504.00	\$ 520.00	22
<b>Stool, Leg Based</b>						
B1-555-S00	Uph Seat, 18"H	\$ 361.00	\$ 357.00	\$ 397.00	\$ 408.00	18
B1-Y55-S00	Uph Seat, 16"H	\$ 361.00	\$ 357.00	\$ 397.00	\$ 408.00	18
B1-J55-S00	Uph Seat, 14"H	\$ 361.00	\$ 357.00	\$ 397.00	\$ 408.00	18
<b>Stool, Sled Based</b>						
B2-655-S00	Uph Seat, 27"H	\$ 416.00	\$ 413.00	\$ 459.00	\$ 471.00	20
B2-555-S00	Uph Seat, 18"H	\$ 361.00	\$ 357.00	\$ 397.00	\$ 408.00	18
B2-Y55-S00	Uph Seat, 16"H	\$ 361.00	\$ 357.00	\$ 397.00	\$ 408.00	18
B2-J55-S00	Uph Seat, 14"H	\$ 361.00	\$ 357.00	\$ 397.00	\$ 408.00	18

Fabric Requirements - non-directional, 54" wide  
 Back - 1/4 yard  
 Seat - 1/2 yard

**Please specify Wood Finish, and Upholstery (if applicable). Details can be found in the Product Options section at the front of this Price List.**

**Carver Chair  
Seating  
2009 Brodart Furniture - List Prices**

Catalog Number	Description	COM	List Price			Weight (lbs)
			Wood/G1	Grade 2	Grade 3	
CA-571-S00	Adult 18" All Wood		\$406.00			25
CA-561-S00	Youth 16" All Wood		\$381.00			25



**Please specify Wood Finish. Details can be found in the Product Options section at the front of this Price List.**

**D Series Chair**  
**Seating**  
**2009 Brodart Furniture - List Prices**

Catalog Number	Description	COM	List Price			Weight (lbs)
			Wood/G1	Grade 2	Grade 3	

**Wood Seats, Oak Plywood Construction**  
**Slat wood backs/solid backs/arched 8" upholstered backs**

**Side Chair, Adult, 18" Leg Base**

D1-551-S00	All Wood		\$ 394.00			23
D1-552-S00	Uph Seat, Slat Back	\$ 481.00	\$ 479.00	\$ 540.00	\$ 559.00	23
D1-553-S00	Uph Back, Arch Back	\$ 431.00	\$ 430.00	\$ 450.00	\$ 468.00	23
D1-554-S00	Uph Back & Seat, Arch Back	\$ 532.00	\$ 526.00	\$ 657.00	\$ 678.00	23

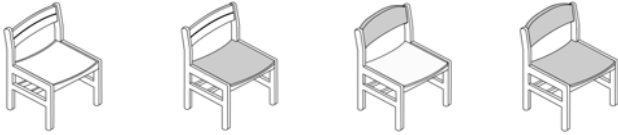

**Side Chair, Adult, 18" Sled Base**

D2-551-S00	All Wood		\$ 394.00			23
D2-552-S00	Uph Seat, Slat Back	\$ 481.00	\$ 479.00	\$ 540.00	\$ 559.00	23
D2-553-S00	Uph Back, Arch Back	\$ 431.00	\$ 430.00	\$ 450.00	\$ 468.00	23
D2-554-S00	Uph Back & Seat, Arch Back	\$ 532.00	\$ 526.00	\$ 657.00	\$ 678.00	23

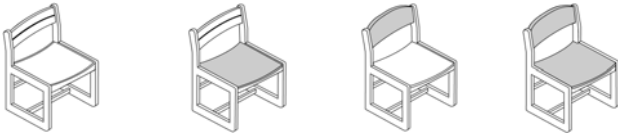

**Wood Seats, Solid Oak Construction (Saddle Seats)**  
**Slat wood backs/solid backs/arched 8" upholstered backs**

**Side Chair, Adult, 18" Leg Base**

D1-551-OAK	All Wood		\$ 408.00			23
D1-552-S00	Uph Seat, Slat Back	\$ 481.00	\$ 479.00	\$ 540.00	\$ 559.00	23
D1-553-OAK	Uph Back, Arch Back	\$ 445.00	\$ 444.00	\$ 466.00	\$ 484.00	23
D1-554-S00	Uph Back & Seat, Arch Back	\$ 532.00	\$ 526.00	\$ 657.00	\$ 678.00	23

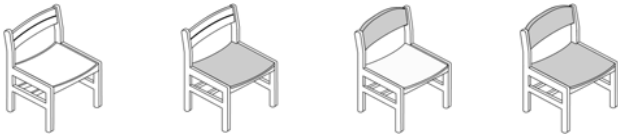

**Side Chair, Adult, 18" Sled Base**



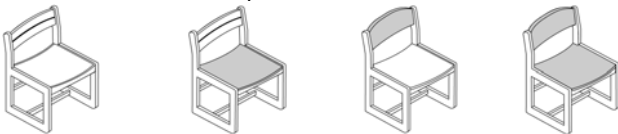









D2-551-OAK	All Wood		\$ 408.00			23
D2-552-S00	Uph Seat, Slat Back	\$ 481.00	\$ 479.00	\$ 540.00	\$ 559.00	23
D2-553-OAK	Uph Back, Arch Back	\$ 445.00	\$ 444.00	\$ 466.00	\$ 484.00	23
D2-554-S00	Uph Back & Seat, Arch Back	\$ 532.00	\$ 526.00	\$ 657.00	\$ 678.00	23



Fabric Requirements - non-directional, 54" wide  
 Back - 1/4 yard  
 Seat - 1/2 yard

**Please specify Wood Finish, and Upholstery (if applicable). Details can be found in the Product Options section at the front of this Price List.**







**Entry Chair Collection**  
**Seating**  
**2009 Brodart Furniture - List Prices**

Catalog Number	Description	COM	List Price			Weight (lbs)
			Wood/G1	Grade 2	Grade 3	
<b>Wood Seat</b>						
002S00W	 Vertical slats w/ curvilinear edge and side supports		\$ 370.00			30
004S00W	 Partial vertical slats w/ wide top portion		\$ 386.00			30
011S00W	 Solid back support w/ half-circle bottom cutout		\$ 356.00			30
023S00W	 Fully extended diamond back support		\$ 366.00			30
028S00W	 Partial vertical slats w/ full back support		\$ 407.00			30
<b>Upholstered Seat</b>						
001S00	 Fluted back support w/ rounded top edge	\$ 378.00	\$ 376.00	\$ 462.00	\$ 484.00	30
002S00	 Fully extended vertical slats w/ curvilinear edge	\$ 408.00	\$ 406.00	\$ 499.00	\$ 522.00	30
004S00	 Partial vertical slats w/ wide top portion	\$ 376.00	\$ 374.00	\$ 497.00	\$ 481.00	30
011S00	 Solid back support w/ half-circle bottom cutout	\$ 373.00	\$ 370.00	\$ 456.00	\$ 476.00	30
017S00	 Fully extended lattice back support	\$ 388.00	\$ 386.00	\$ 474.00	\$ 496.00	30
023S00	 Fully extended diamond back support	\$ 382.00	\$ 380.00	\$ 468.00	\$ 602.00	30
028S00	 Partial vertical slats w/ full back support	\$ 394.00	\$ 392.00	\$ 482.00	\$ 504.00	30

Fabric Requirements - 1/2 yd per chair, non-directional, 54" wide

**Please specify Wood Finish, and Upholstery (if applicable). Details can be found in the Product Options section at the front of this Price List.**

**Ergonomic Seating**  
**Seating**  
**2009 Brodart Furniture - List Prices**





Catalog Number	Description	COM	List Price			Weight (lbs)
			Wood/G1	Grade 2	Grade 3	
<b>Task Seating</b>						
63-620-S00	Inertia High Mesh Back Chair **	\$ 985.00	\$ 981.00	\$ 1,211.00	\$ 1,262.00	45
						
63-621-S00	Inertia Midback Upholstered	\$ 1,104.00	\$ 1,101.00	\$ 1,293.00	\$ 1,513.00	45
						
63-602-S00	Go Task Chair	\$ 1,035.00	\$ 1,033.00	\$ 1,315.00	\$ 1,457.00	40
						
<b>Technician, High Base Seating</b>						
63-604-S00	Go Midback Stool w/ Arms	\$ 1,049.00	\$ 1,046.00	\$ 1,241.00	\$ 1,467.00	45
						
<b>Side Chairs</b>						
<b>Inertia Mesh Back Chair</b>						
63-622-S00	Inertia, no arms, no casters**	\$ 445.00	\$ 443.00	\$ 549.00	\$ 571.00	22
63-623-S00	Inertia, no arms, w/ casters**	\$ 516.00	\$ 514.00	\$ 636.00	\$ 660.00	22
						
63-624-S00	Inertia, w/ ams, no casters**	\$ 516.00	\$ 514.00	\$ 636.00	\$ 660.00	22
63-625-S00	Inertia, w/ arms, w/ casters**	\$ 585.00	\$ 583.00	\$ 722.00	\$ 750.00	22
						

\*\* Special upholstery requirements

**Note:** All chairs on this page ship from a separate location at no freight charge

**Please specify Upholstery. Details can be found in the Product Options section at the front of this Price List.**

**Essex Chair  
Seating  
2009 Brodart Furniture - List Prices**

Catalog Number	Description	COM	List Price			Weight (lbs)
			Wood/G1	Grade 2	Grade 3	
<b>Solid Wood Seat (Scooped)</b>						
15-451-S00	w/ Solid Top Slat		\$ 731.00			30
						
15-471-S00	w/ Top Slat Cutout		\$ 760.00			30
						
<b>Upholstered Seat</b>						
15-454-S00	w/ Solid Top Slat	\$ 852.00	\$ 846.00	\$ 1,020.00	\$ 1,055.00	30
						
15-474-S00	w/ Top Slat Cutout	\$ 881.00	\$ 875.00	\$ 1,055.00	\$ 1,089.00	30
						





Fabric Requirements - 1/2 yd per chair, non-directional, 54" wide

**Please specify Wood Finish, and Upholstery (if applicable). Details can be found in the Product Options section at the front of this Price List.**

# Horizons Seating (prices shown in Maple wood)

## Seating

### 2009 Brodart Furniture - List Prices









Catalog Number	Description	COM	List Price			Weight (lbs)
			Wood/G1	Grade 2	Grade 3	
<b>Horizons Wood Frame Chair w/ Cutout</b>						
77-571-S00	Adult, Leg Base, All Wood		\$ 496.00			23
77-561-S00	Youth, Leg Base, All Wood		\$ 496.00			22
						
77-572-S00	Adult, Leg Base, Upholstered Seat	\$ 585.00	\$ 581.00	\$ 657.00	\$ 680.00	23
77-562-S00	Youth, Leg Base, Upholstered Seat	\$ 585.00	\$ 581.00	\$ 657.00	\$ 680.00	22
						
<b>Horizons Metal Frame Chair w/ Cutout</b>						
77A-571-S00	Adult, Leg Base, All Wood		\$ 780.00			25
77A-561-S00	Youth, Leg Base, All Wood		\$ 780.00			25
						
77A-572-S00	Adult, Leg Base, Upholstered Seat	\$ 879.00	\$ 873.00	\$ 994.00	\$ 1,021.00	25
77A-562-S00	Youth, Leg Base, Upholstered Seat	\$ 831.00	\$ 827.00	\$ 930.00	\$ 962.00	25
						
77-864-S00	Hassock, 15" x 15" x 15"H	\$ 614.00	\$ 609.00	\$ 685.00	\$ 708.00	18

Fabric Requirements - 3/4 yd per chair, non-directional, 54" wide

**Please specify Wood Finish, Upholstery, and Metal Color (if applicable). Details can be found in the Product Options section at the front of this Price List.**



**Melis Chair  
Seating  
2009 Brodart Furniture - List Prices**

Catalog Number	Description	COM	List Price			Weight (lbs)
			Wood/G1	Grade 2	Grade 3	
<b>All Wood Chair, Oak Wood</b>						
ME-551-S00	Adult, 18"H Seat		\$ 413.00			25
ME-561-S00	Youth, 16"H Seat		\$ 413.00			24
ME-541-S00	Juvenile, 14"H Seat		\$ 413.00			23
						
<b>Upholstered Seat, Oak Wood</b>						
ME-552-S00	Adult, 18"H Seat	\$ 448.00	\$ 446.00	\$ 553.00	\$ 713.00	25
ME-562-S00	Youth, 16"H Seat	\$ 448.00	\$ 446.00	\$ 553.00	\$ 713.00	24
ME-542-S00	Juvenile, 14"H Seat	\$ 448.00	\$ 446.00	\$ 553.00	\$ 713.00	23
						
<b>All Wood Chair, w/ Arms, Oak Wood</b>						
ME-581-S00	Adult, 18"H Seat, w/Arms		\$ 499.00			30
ME-591-S00	Youth, 16"H Seat, w/ Arms		\$ 499.00			29
ME-531-S00	Juvenile, 14"H Seat, w/ Arms		\$ 499.00			28
						
<b>Upholstered Seat, w/ Arms, Oak Wood</b>						
ME-582-S00	Adult, 18"H Seat, w/Arms	\$ 523.00	\$ 521.00	\$ 646.00	\$ 833.00	30
ME-592-S00	Youth, 16"H Seat, w/ Arms	\$ 523.00	\$ 521.00	\$ 646.00	\$ 833.00	29
ME-532-S00	Juvenile, 14"H Seat, w/ Arms	\$ 523.00	\$ 521.00	\$ 646.00	\$ 833.00	28
						
<b>All Wood Chair, Maple Wood</b>						
ME-551-S00-MAP	Adult, 18"H Seat		\$ 475.00			25
ME-561-S00-MAP	Youth, 16"H Seat		\$ 475.00			24
ME-541-S00-MAP	Juvenile, 14"H Seat		\$ 475.00			23
						
<b>Upholstered Seat, Maple Wood</b>						
ME-552-S00-MAP	Adult, 18"H Seat	\$ 511.00	\$ 509.00	\$ 631.00	\$ 813.00	25
ME-562-S00-MAP	Youth, 16"H Seat	\$ 511.00	\$ 509.00	\$ 631.00	\$ 813.00	24
ME-542-S00-MAP	Juvenile, 14"H Seat	\$ 511.00	\$ 509.00	\$ 631.00	\$ 813.00	23
						
<b>All Wood Chair, w/ Arms, Maple Wood</b>						
ME-581-S00-MAP	Adult, 18"H Seat, w/Arms		\$ 563.00			30
ME-591-S00-MAP	Youth, 16"H Seat, w/ Arms		\$ 563.00			29
ME-531-S00-MAP	Juvenile, 14"H Seat, w/ Arms		\$ 563.00			28
						
<b>Upholstered Seat, w/ Arms, Maple Wood</b>						
ME-582-S00-MAP	Adult, 18"H Seat, w/Arms	\$ 582.00	\$ 580.00	\$ 719.00	\$ 926.00	30
ME-592-S00-MAP	Youth, 16"H Seat, w/ Arms	\$ 582.00	\$ 580.00	\$ 719.00	\$ 926.00	29
ME-532-S00-MAP	Juvenile, 14"H Seat, w/ Arms	\$ 582.00	\$ 580.00	\$ 719.00	\$ 926.00	28
						

Fabric Requirements - 1/2 yd per chair, non-directional, 54" wide

**Please specify Wood Finish, and Upholstery (if applicable). Details can be found in the Product Options section at the front of this Price List.**

**Metro Chair**  
**Seating**  
**2009 Brodart Furniture - List Prices**

Catalog Number	Description	COM	List Price			Weight (lbs)
			Wood/G1	Grade 2	Grade 3	
<b>Wood Seat &amp; Back, Oak Wood</b>						
G1-571-S00	Adult, All Wood, 18"H		\$ 435.00			23
G1-561-S00	Youth, All Wood, 16"H		\$ 435.00			22



**Upholstered Seat & Back, Oak Wood**

G1-574-S00	Adult, Uph Back & Seat, 18"H	\$ 572.00	\$ 570.00	\$ 707.00	\$ 735.00	23
G1-564-S00	Youth, Uph Back & Seat, 16"H	\$ 572.00	\$ 570.00	\$ 707.00	\$ 735.00	22



Fabric Requirements - 1 yd per chair, non-directional, 54" wide

**Please specify Wood Finish, and Upholstery (if applicable). Details can be found in the Product Options section at the front of this Price List.**

**Netta Chair  
Seating  
2009 Brodart Furniture - List Prices**

Catalog Number	Description	COM	List Price			Weight (lbs)
			Wood/G1	Grade 2	Grade 3	

**Wood Seat**

NE-571-S00	All Wood Chair		\$ 629.00			25
------------	----------------	--	-----------	--	--	----



**Upholstered Seat**

NE-572-S00	Upholstered Seat	\$ 686.00	\$ 682.00	\$ 819.00	\$ 852.00	25
------------	------------------	-----------	-----------	-----------	-----------	----



Fabric Requirements - 1/2 yd per chair, non-directional, 54" wide

**Please specify Wood Finish, and Upholstery (if applicable). Details can be found in the Product Options section at the front of this Price List.**

**Oxford Chair  
Seating  
2009 Brodart Furniture - List Prices**

Catalog Number	Description	COM	List Price			Weight (lbs)
			Wood/G1	Grade 2	Grade 3	

**Solid Wood Seat (Scooped)**

OX-571-S00	Vertical Slats w/ Scooped Wood Seat		\$613.00			26
------------	-------------------------------------	--	----------	--	--	----



**Upholstered Seat**





OX-572-S00	Vertical Slats, Uph Seat	\$693.00	\$690.00	\$858.00	\$893.00	28
------------	--------------------------	----------	----------	----------	----------	----



Fabric Requirements - 1/2 yd per chair, non-directional, 54" wide

**Please specify Wood Finish, and Upholstery (if applicable). Details can be found in the Product Options section at the front of this Price List.**

**Parallax Chair  
Seating  
2009 Brodart Furniture - List Prices**

Catalog Number	Description	COM	List Price			Weight (lbs)
			Wood/G1	Grade 2	Grade 3	
<b>Solid Wood Seat (Scooped)</b>						
15-551-S00	Parallax w/Solid Top Slat		\$763.00			30
						
15-571-S00	Parallax w/Top Slat Cutout		\$793.00			30
						
<b>Upholstered Seat</b>						
15-554-S00	Parallax w/Solid Top Slat	\$903.00	\$896.00	\$1,074.00	\$1,111.00	30
						
15-574-S00	Parallax w/Top Slat Cutout	\$933.00	\$926.00	\$1,110.00	\$1,148.00	30
						

Fabric Requirements - 1/2 yd per chair, non-directional, 54" wide

**Please specify Wood Finish, and Upholstery (if applicable). Details can be found in the Product Options section at the front of this Price List.**

**Two Position Chair  
Seating  
2009 Brodart Furniture - List Prices**

Catalog Number	Description	COM	List Price			Weight (lbs)
			Wood/G1	Grade 2	Grade 3	

**All Wood Chair**

2P-571-S00	All wood chair		\$ 408.00			27
------------	----------------	--	-----------	--	--	----



**Upholstered Seat & Back**

2P-574-S00	Uph Seat & Back	\$ 499.00	\$ 495.00	\$ 630.00	\$ 658.00	27
------------	-----------------	-----------	-----------	-----------	-----------	----



Fabric Requirements - 3/4 yd per chair, non-directional, 54" wide

**Please specify Wood Finish, and Upholstery (if applicable). Details can be found in the Product Options section at the front of this Price List.**



**Lounge Seating**  
**2009 Brodart Furniture - List Prices**

Catalog Number	Description	COM	List Price			Weight (lbs)
			Wood/G1	Grade 2	Grade 3	
<b>Berwyn Collection</b>						
66-111-S00	Single Seat	\$ 3,449.00	\$ 3,428.00	\$ 4,000.00	\$ 4,172.00	65
66-211-S00	Two Seat	\$ 4,464.00	\$ 4,432.00	\$ 5,578.00	\$ 5,875.00	110
62-311-S00	Three Seat	\$ 5,510.00	\$ 5,471.00	\$ 7,191.00	\$ 7,636.00	162

Fabric Requirements - non-directional, 54" wide

One Seat - 2 yards

Two Seat - 4 yards

Three Seat - 6 yards

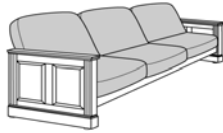
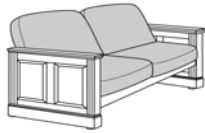
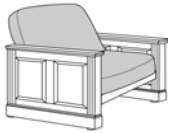

**Chancellor's Collection**

CH2-101-S00	Single Seat w/Panel Frame	\$ 2,273.00	\$ 2,190.00	\$ 2,762.00	\$ 2,934.00	65
CH2-201-S00	Two Seat w/Panel Frame	\$ 3,218.00	\$ 3,053.00	\$ 4,199.00	\$ 4,497.00	110
CH2-301-S00	Three Seat w/Panel Frame	\$ 4,059.00	\$ 3,813.00	\$ 5,533.00	\$ 5,978.00	162

Fabric Requirements - non-directional, 54" wide

One Seat - 2 yards

Two Seat - 4 yards

Three Seat - 6 yards



**Please specify Wood Finish, and Upholstery. Details can be found in the Product Options section at the front of this Price List.**



**Lounge Seating**  
**2009 Brodart Furniture - List Prices**

Catalog Number	Description	COM	List Price			Weight (lbs)
			Wood/G1	Grade 2	Grade 3	
<b>L4 Lounge</b>						
L4-121-S00	Lounge Chair Fully Upholstered	\$ 2,171.00	\$ 2,109.00	\$ 2,355.00	\$ 2,628.00	55
L4-122-S00	Lounge Chair w/ Curved Oak Arm Caps	\$ 2,390.00	\$ 2,322.00	\$ 2,594.00	\$ 2,894.00	55
L4-122-S02	Lounge Chair w/ Curved Maple Arm Caps	\$ 2,433.00	\$ 2,365.00	\$ 2,640.00	\$ 2,946.00	55

Fabric Requirements - 6 1/2 yards per chair, non-directional, 54" wide



**L5 Series Lounge**

L5-102-S00	Single Seat, Open Frame	\$ 1,582.00	\$ 1,566.00	\$ 1,851.00	\$ 1,939.00	45
L5-103-S00	Single Seat w/Wood Insert	\$ 1,826.00	\$ 1,773.00	\$ 2,058.00	\$ 2,146.00	47
L5-104-S00	Single Seat w/Uph Insert	\$ 1,946.00	\$ 1,869.00	\$ 2,168.00	\$ 2,259.00	47
L5-212-S00	Two Seat, Open Frame	\$ 2,485.00	\$ 2,374.00	\$ 2,946.00	\$ 3,118.00	80
L5-213-S00	Two Seat w/Wood Insert	\$ 2,917.00	\$ 2,759.00	\$ 3,331.00	\$ 3,503.00	82
L5-214-S00	Two Seat w/Uph Insert	\$ 3,105.00	\$ 2,932.00	\$ 3,518.00	\$ 3,700.00	82
L5-312-S00	Three Seat, Open Frame	\$ 3,302.00	\$ 3,133.00	\$ 3,992.00	\$ 4,251.00	115
L5-313-S00	Three Seat w/Wood Insert	\$ 3,728.00	\$ 3,490.00	\$ 4,349.00	\$ 4,607.00	117
L5-314-S00	Three Seat w/Uph Insert	\$ 3,905.00	\$ 3,651.00	\$ 4,522.00	\$ 4,779.00	117

Fabric Requirements - non-directional, 54" wide

- One Seat - 2 yards
- One Seat w/Wood Insert - 3 yards
- One Seat w/Uph Insert - 4 yards
- Two Seat - 4 yards
- Two Seat w/Wood Insert - 5 yards
- Two Seat w/Uph Insert - 6 yards
- Three Seat - 6 yards
- Three Seat w/Wood Insert - 7 yards
- Three Seat w/Uph Insert - 9 yards



**Please specify Wood Finish, and Upholstery (if applicable). Details can be found in the Product Options section at the front of this Price List.**

**Lounge Tables**  
**2009 Brodart Furniture - List Prices**

Catalog Number	List Price	Description	Weight (lbs)
<b>Epoch Collection</b>			
<b>Wood Leg</b>			
59W-610-S00	\$ 1,923.00	36" Dia. x 16"H	70
59W-611-S00	\$ 1,503.00	24"D x 48"W x 16"H	60
59W-621-S00	\$ 1,610.00	30"D x 30"W x 16"H	47
<b>Powder Coated Leg</b>			
59-610-S00	\$ 1,923.00	36" Dia. x 16"H	70
59-611-S00	\$ 1,503.00	24"D x 48"W x 16"H	60
59-621-S00	\$ 1,610.00	30"D x 30"W x 16"H	47
<b>Chrome Leg</b>			
59C-610-S00	\$ 2,308.00	36" Dia. x 16"H	70
59C-611-S00	\$ 1,803.00	24"D x 48"W x 16"H	60
59C-621-S00	\$ 1,932.00	30"D x 30"W x 16"H	47
<b>Berwyn Collection</b>			
66-611-S00	\$ 1,738.00	24"D X 48"W X 17"H	60
66-621-S00	\$ 1,676.00	30"D X 30"W X 23"H	47
<b>Chancellor's Collection</b>			
CH2-610-S00	\$ 1,860.00	38" Dia. x 16" H	70
CH2-611-S00	\$ 1,455.00	26" D x 50" W x 16" H	60
CH2-621-S00	\$ 1,558.00	32" D x 32" W x 16" H	47
<b>LX Series</b>			
LX-626-S00	\$ 1,313.00	36" Dia x 16"H	66
LX-627-S00	\$ 1,156.00	24" x 48" x 16"H	46
LX-625-S00	\$ 1,092.00	30" x 30" x 16"H	51

**Please specify Wood Finish, Laminate, and Metal Color (if applicable). Details can be found in the Product Options section at the front of this Price List.**

**Lounge Tables**  
**2009 Brodart Furniture - List Prices**

Catalog Number	List Price	Description	Weight (lbs)
<b>Libris 4W Series</b>			
4W-626-S00	\$ 1,419.00	36" Dia x 16"H	66
4W-627-S00	\$ 1,261.00	48" x 24" x 16"H	46
4W-625-S00	\$ 1,204.00	30" x 30" x 16"H	51
4W-628-S00	\$ 988.00	24" x 24" x 22"H, End Table	45
4W-629-S00	\$ 1,026.00	24" x 30" x 22"H, End Table	48
<b>Libris 4M Series</b>			
4M-626-S00	\$ 1,457.00	36" Dia x 16"H	66
4M-627-S00	\$ 1,292.00	48" x 24" x 16"H	46
4M-625-S00	\$ 1,248.00	30" x 30" x 16"H	51
	\$ -		
4M-628-S00	\$ 1,020.00	24" x 24" x 22"H, End Table	45
4M-629-S00	\$ 1,058.00	24" x 30" x 22"H, End Table	48
<b>Quorum 94T Series</b>			
94T-626-S00	\$ 1,394.00	36" Dia x 16"H	66
94T-627-S00	\$ 1,400.00	48" x 24" x 16"H	46
94T-625-S00	\$ 1,235.00	30" x 30" x 16"H	51
94T-628-S00	\$ 995.00	24" x 24" x 22"H, End Table	45
94T-629-S00	\$ 1,039.00	24" x 30" x 22"H, End Table	48
<b>Cylinder lounge tables</b>			
60-620-000	\$ 1,003.00	18" Dia x 18"H	20
60-621-000	\$ 1,240.00	24" Dia x 18"H	31
60-622-000	\$ 1,417.00	30" Dia x 18"H	42
<b>Cube lounge tables</b>			
60-610-000	\$ 1,292.00	18" D x 18" W x 18"H	50
60-611-000	\$ 1,443.00	24" D x 24" W x 18"H	73
60-612-000	\$ 1,664.00	30" D x 30" W x 18"H	100

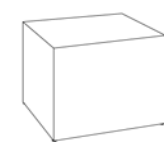
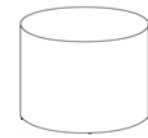

Please specify Wood Finish, Laminate, and Metal Color (if applicable). Details can be found in the Product Options section at the front of this Price List.

**Banbury Chair Collection**  
**Seating**  
**2009 Brodart Furniture - List Prices**

Catalog Number	Description	COM	List Price			Weight (lbs)
			Wood/G1	Grade 2	Grade 3	

**When ordered, one of the following back designs must be specified as part of the catalog number. I.e.: an All Wood Adult Height chair in Oak wood with the "Horizontal Slats" back design would be BBH-551-S00.**



H - Horizontal Slats



Q - Quarter Circles



T - Triangles

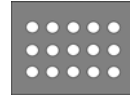

C - Circles



P - Picture Frame

**All Wood Chair, Oak Wood**

BB_-551-S00	Adult, 18"H Seat		\$	784.00				22
BB_-561-S00	Youth, 16"H Seat		\$	784.00				21

**All Wood Chair, Maple Wood**

BB_-551-S00-MAP	Adult, 18"H Seat		\$	784.00				22
BB_-561-S00-MAP	Youth, 16"H Seat		\$	784.00				21

**Upholstered Seat, Oak Wood**

BB_-552-S00	Adult, 18"H Seat		\$	897.00	\$	893.00	\$	1,076.00	\$	1,113.00	22
BB_-562-S00	Youth, 16"H Seat		\$	897.00	\$	893.00	\$	1,076.00	\$	1,113.00	21

**Upholstered Seat, Maple Wood**

BB_-552-S00-MAP	Adult, 18"H Seat		\$	897.00	\$	893.00	\$	1,076.00	\$	1,113.00	22
BB_-562-S00-MAP	Youth, 16"H Seat		\$	897.00	\$	893.00	\$	1,076.00	\$	1,113.00	21

**All Wood Chair, w/ Arms, Oak Wood**

BB_-581-S00	Adult, 18"H Seat, w/Arms		\$	897.00						28
BB_-591-S00	Youth, 16"H Seat, w/ Arms		\$	897.00						27

**All Wood Chair, w/ Arms, Maple Wood**

BB_-581-S00-MAP	Adult, 18"H Seat, w/Arms		\$	897.00						28
BB_-591-S00-MAP	Youth, 16"H Seat, w/ Arms		\$	897.00						27

**Upholstered Seat, w/ Arms, Oak Wood**

BB_-582-S00	Adult, 18"H Seat, w/Arms		\$	997.00	\$	993.00	\$	1,197.00	\$	1,238.00	28
BB_-592-S00	Youth, 16"H Seat, w/ Arms		\$	997.00	\$	993.00	\$	1,197.00	\$	1,238.00	27

**Upholstered Seat, w/ Arms, Maple Wood**

BB_-582-S00-MAP	Adult, 18"H Seat, w/Arms		\$	997.00	\$	993.00	\$	1,197.00	\$	1,238.00	28
BB_-592-S00-MAP	Youth, 16"H Seat, w/ Arms		\$	997.00	\$	993.00	\$	1,197.00	\$	1,238.00	27

**When ordered, one of the following back designs must be specified as part of the catalog number. I.e.: an All Wood Adult Height chair in Oak wood with the "Horizontal Slats" back design would be BBH-551-S00.**

**Please specify Back Design, Wood, Metal Color, and Upholstery (if applicable)**

**Lounge Seating**  
**2009 Brodart Furniture - List Prices**

Catalog Number	Description	COM	List Price			Weight (lbs)
			Wood/G1	Grade 2	Grade 3	
<b>2be! Lounge Collection</b>						
<b>Oak Wood</b>						
2BE-O-101-S00	Single Seat Lounge Chair	\$ 2,112.00	\$ 2,035.00	\$ 2,567.00	\$ 2,726.00	45
2BE-O-201-S00	Two Seat Lounge Chair	\$ 3,484.00	\$ 3,305.00	\$ 4,546.00	\$ 4,867.00	80
<b>Maple Wood</b>						
2BE-M-101-S00	Single Seat Lounge Chair	\$ 2,112.00	\$ 2,035.00	\$ 2,567.00	\$ 2,726.00	45
2BE-M-201-S00	Two Seat Lounge Chair	\$ 3,484.00	\$ 3,305.00	\$ 4,546.00	\$ 4,867.00	80

**Please specify End Panel Finish, Arm Cap Finish, and Upholstery.**



**2be! Lounge Tables**

**Oak Wood**

2BE-O-30RD16-AMLS	30" Dia x 16"H		\$ 1,481.00	45
2BE-O-36RD16-AMLS	36" Dia x 16"H		\$ 1,548.00	50

**Maple Wood**

2BE-M-30RD16-AMLS	30" Dia x 16"H		\$ 1,481.00	45
2BE-M-36RD16-AMLS	36" Dia x 16"H		\$ 1,548.00	50



**Oak Wood**

2BE-O-242416-AMLS	24" x 24" x 16"H		\$ 1,109.00	45
2BE-O-303016-AMLS	30" x 30" x 16"H		\$ 1,162.00	50

**Maple Wood**

2BE-M-242416-AMLS	24" x 24" x 16"H		\$ 1,109.00	45
2BE-M-303016-AMLS	30" x 30" x 16"H		\$ 1,162.00	50



**Oak Wood**

2BE-O-482416-AMLS	48" x 24" x 16"H		\$ 1,201.00	55
-------------------	------------------	--	-------------	----

**Maple Wood**

2BE-M-482416-AMLS	48" x 24" x 16"H		\$ 1,201.00	55
-------------------	------------------	--	-------------	----



**Please specify Wood Finish, Laminate, and Metal Color.**